



2023/2024



Erläuterungen/Descriptions 10-11

Produkt-Info-Skizzen – Druckpositionen – Druckverfahren – Hinweise zu Farb-Codes
 Informative Product Sketches – Print Positions – Printing Methods – Notes on the color codes







uma NEWS 12-19

Besonderheiten/Speciality

	umaPRIME	20-21
	uma – rPET	26-49
	uma – Antibakteriell/antibacterial	40-41 + 50-53
	uma NFC	82-84
	uma GUMON!	90-95
	uma QR-CODE	100-101
	uma BlackForest-Pens	120-139
	uma VISUAL	144-153
	uma Farbvielfalt/uma variety of colors	172-175
	uma Glänzend werben/uma promote brilliant	228-231

Natur/Natural 22-77

























	BEECH	71
	BIO PEN	77
	CALIBRA	70
	CETA RECY	66
	CHILL RECY	66
	EFFECT GREEN	51
	ELEGANCE WOOD	75
	FOREST	71
	HAPPY RECY	59
	ICON GREEN	51

























	ICONIC RECY	61
	LEAF	69
	PAPER PEN	77
	RECYCLED PET PEN	48-49
	RECYCLED PET PEN ALUMA	45 new!
	RECYCLED PET PEN PRO	28-43 new!
	RECYCLED PET PEN STEP	26-27 new!
	RECYCLED PET PEN switch	46-47
	PIXEL GREEN	52
	PIXEL RECY	65
	POP RECY	63
	ON TOP RECY	64
	TREE	69 new!
	TITAN WOOD	73
	ULTIMATE RECY	67
	YES ANTIBAC	53
	YES RECY	53
	VANE RECY	62
	VITAN RECY	55
	WOODY	70



Kunststoff/Plastic

78-205

	ARCTIS	169
	BEAT	115
	CANDY	156-159
	CETA	135

















	CHECK	124-127
	CHIC	134
	CHILL	128-129
	CORAL	94-97
	CRYS	136-137
	DOT	162-163
	DROP	198-199
	EFFECT	186-187
	ENERGY	153
	FANTASY	152
	FASHION	148-149
	FLEXI	204
	FUSION	196-197
	GEOS	138-139
	HAPPY	110-111
	ICON	190-191
	ICONIC	188-189
	JAZZ	168
	KLICK	164-165
	LINEO	102-103
	LOOK	160-161
	MEMORY	142-143
	OMEGA	140-141
	ON TOP	176-179
	PEPP	132
	PIXEL	192-193













	POP	184-185
	PREMIUM	204
	PRIMA	116-117
	PUR	166-167
	QUANTUM	170-171
	RINGO	194-195
	SKY	86-89
	SPIRIT	202
	SPLASH	200-201
	SPOT	133
	STREAM	98-99
	STRIPE	201
	SUNNY	152
	TORSION	202
	TRINITY	80-85
	TWISTY	114
	ULTIMATE	131
	ULTIMO	130
	UP	112-113
	VANE	180-183
	VARIO	205
	VIANI	202
	VISTA	203
	VITAN	203
	VOGUE	150-151

	WAVE	154-155
	X-DREAM	118-119
	YES	104-109

Metall/Metal

206-279





	2in1	276-277
	ARGON	262
	ARGUS	262
	BOOM	270-271
	BRIGHT	234-235
	BRUSH	232-233
	CARBON	216
	CLASSICO	224
	COMMA	264-265
	COSMOS	263
	ELEGANCE	214-215
	ELLIPSE	236-237
	ETERNITY	218-219
	GALILEO C	217
	GROOVE	254-255
	LADY	225
	LUCKY	265
	LUMOS	246-249
	MESH	220-221 new!
	MOON	260

	NOBILIS	217
	OPERA	226-227
	PIANO	258-259
	PRIMUS	252-253
	PYRA	244-245
	RONDO	263
	SHADOW	272-273
	SHORTY	279
	SILENCE	224
	SIX	256-257
	SKINNY TOUCH	278-279
	SLIDE	274-275
	SLIMLINE	268-269
	SMOKE	259
	SOUL	222-223
	STRAIGHT	238-243
	SUPREME	266-267
	TAROT	261
	TALIS	250-251
	TITAN	212-213
	VENUS	260
	VIP	210-211
	VIPOLINO	208-209

Highlighter/Highlighter 280-289

	LIQEO HIGHLIGHTER	282-285
	LIQEO HIGHLIGHTER SET	283-285
	myBASE	289
	TEXTMARKER	288
	TEXTMARKER 2er SET	288
	TEXTMARKER SET	288
	TEXTMARKER SET SI	289
	WRITE & HIGHLIGHT	286-287

Zubehör/Accessoires 290-301

	DESK	293
	ETUIS	294-301 new!
	HAFTKLAMMER	294
	OFFICE	293
	myPENbook	292

Minen/Refills 302-309

	MINEN	300-309
---	-------	---------

Erläuterungen/Descriptions 310-317

Druckvorlagen & Veredelungen/Printing Templates & Finishing	310-315
Lasergravuren/Laser Engravings	316-317
Numerisches Inhaltsverzeichnis/Numerical Table of Contents	318-323

Große Vielfalt, schneller Überblick

Die uma Schreibgeräte setzen sich aus vielen Komponenten zusammen, mit einer Vielfalt an Farb-Optionen und unterschiedlichen Druckpositionen. Zur schnellen Übersicht über die verfügbaren Gestaltungsmöglichkeiten finden Sie auf jeder Produktseite eine Produkt-Info-Skizze mit dem jeweiligen Schreibgerät, der gesamten Auswahl an Standard-Farben des Modells und den Angaben der zur Verfügung stehenden Druckpositionen mit entsprechenden Maßen (Länge x Höhe in mm).

Für die Beschreibung der Druckposition und der Druckverfahren gibt es spezielle Info-Schlüssel, vgl. unten. Bitte achten Sie auf die Nummer (①–⑦) der jeweilig verfügbaren Druckposition bzw. auf den Buchstaben (Druckschlüssel S, T, TT, L, RD, RL, EL, HD, V, D, MS, MT, P, GS, GT) des entsprechend geeigneten Druckverfahrens. uma – große Vielfalt, schneller Überblick.

Produkt-Info-Skizzen (Aufbau)

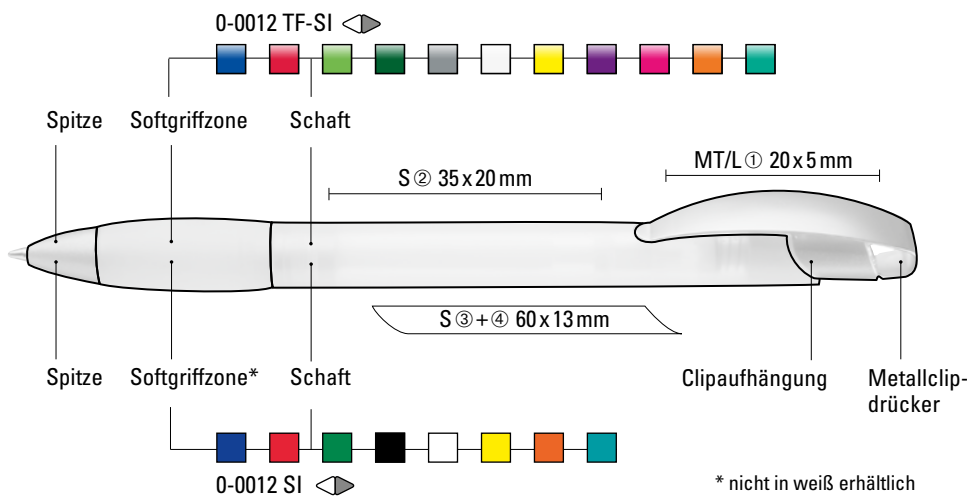

Gedechte Farben, Beispiele:



Gefrostete Farben, Beispiele:



Transparente Farben, Beispiele:



Druckpositionen

- ① auf dem Clip
- ② in Clipverlängerung
- ③ gegenüber dem Clip
- ④ seitlich vom Clip
- ⑤ auf der Kappe / auf dem Oberteil
- ⑥ Stopfen
- ⑦ seitliche Clipbefestigung

Druckverfahren (Druckschlüssel)

- S = Siebdruck
- T = Tampondruck
- TT = Tampondruck auf Sonderformaten
- L = Lasergravur
- EL = Einzelnamensgravur
- RD = Relieffdruck
- RL = Rundumlasergravur
- HD = Digitaldruck
- V = Visual-Folientransferdruck
- D = Doming

- Tampon- oder Siebdruck auf Metall, Holz oder lackierten bzw. gummierten Oberflächen:
- MS = Siebdruck auf Metall
- MT = Tampondruck auf Metall
- P = Sonderdruck
- GS = Siebdruck auf gummierten Oberflächen
- GT = Tampondruck auf gummierten Oberflächen



- Rundumdruck möglich
- ◀▶ Mix and Match Modell

- = Etikettendruck möglich
- ◊ = Uni-Modell

Hinweise zu Farb-Codes

Die komplette Farbauswahl der Produkte wurde in Form von Einklinkern abgebildet. Die dazugehörigen Farbcodes setzen sich so zusammen, dass die letzten vier Ziffern der jeweiligen PMS-Farbe entsprechen. Basierend auf den Nummern des Pantone-Farbfächers.

Da es sich hierbei um unverbindliche Angaben handelt, bitte vor einer Bestellung die Originalmuster zur Freigabe anfordern. Wichtig: Zu jeder Bestellung die Farbnummern angeben!

Farb-Code/Minen	
Artikelnummer →	0-0133 (● 8-0855)
	0-0133 SI (● 8-0855)
	50-0002
	50-0001
	↑ Farb-Code



The Whole Range At A Glance

The uma writing instruments combine numerous components with a wide range of color options and various print positions. With all these design choices, it's a good thing every product page has an informative product sketch of each writing instrument, the full range of standard colors for the model and information about available imprint positions with dimensions (length x height in mm).

There are special information codes describing imprint positions and printing methods – see below for more. Please note the number (①–⑦) of the available imprint position and the letter (printing code S, T, TT, L, RD, RL, EL, HD, V, D, MS, MT, P, GS, GT) of your chosen printing method. At uma, you can see the whole range at a glance.

Informative Product Sketches (Structure)

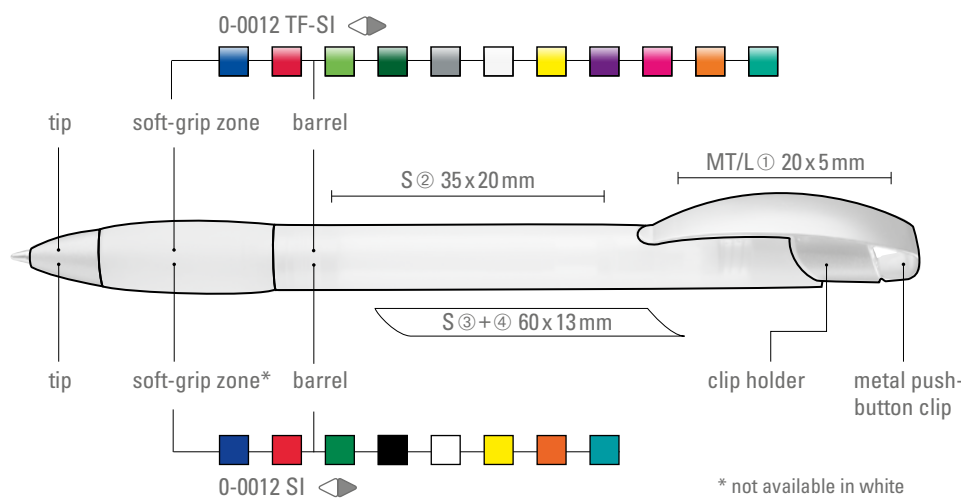

Solid Colors, Examples:



Frosted Colors, Examples:



Transparent Colors, Examples:



* not available in white



Print Positions

- ① On the clip
- ② In front of the clip
- ③ On the opposite side of the clip
- ④ Beside the clip
- ⑤ On the cap/ on the upper part
- ⑥ Plug
- ⑦ Lateral clip fastening

- All-around imprint
- ◀▶ Mix and Match Model

Printing Methods (Printing Code)

- S = Silk screen
- T = Pad printing
- TT = Pad printing on special formats
- L = Laser engraving
- EL = Individual name engraving
- RD = Relief printing
- RL = 360° Laser engraving
- HD = Digital printing
- V = Foil transfer imprint
- D = Doming



- = Print on inner barrel possible
- ◇ = One-colored model



Pad or silk screen printing on metallic, wooden or laquered rather rubberized surfaces:
 MS = Silk screen on metal
 MT = Pad printing on metal
 P = Special print
 GS = Silk screen on rubberized surfaces
 GT = Pad printing on rubberized surfaces

Notes On The Color Codes

The complete color selection of the products has been depicted in the form of inserts. The respective color codes are comprised in such a way that the last four numbers correspond to the respective PMS color. Based on the numbers of the Pantone color palette.

As this is non-binding information, please request the original samples for approval before placing an order.

Important: Please indicate the color numbers with each order!

Colour code/Refills	
Item No. →	0-0133 (● 8-0855)
	0-0133 SI (● 8-0855)
	50-0002
	50-0001
	↑
	Color code



NEWS



RECYCLED PET PEN PRO
0-2250
ab Seite/from page 28

RECYCLED PET PEN PRO Roller
0-2252 R
ab Seite/from page 34

RECYCLED PET PEN PRO LIQEO
0-2255
ab Seite/from page 35

RECYCLED PET PEN PRO frozen SI
0-2250 TF-SI
ab Seite/from page 36



UMC[®]
PRIME



RECYCLED PET PEN
PRO F ocean
0-2250 F OCEAN
ab Seite/from page 38

RECYCLED PET PEN STEP F
0-2210 F
ab Seite/from page 26

ON TOP RECY
0-0063 RECY
ab Seite/from page 64

TITAN WOOD
0-9370 WOOD
ab Seite/from page 72



Das Zeichen für verantwortungsvolle Holzwirtschaft



CORAL GUM
0-0177 GUM
ab Seite/from page 94

TRINITY KG SI GUM
0-0133 KG-SI GUM
ab Seite/from page 84

TRINITY K transparent SI GUM
0-0133 KT-SI GUM
ab Seite/from page 80

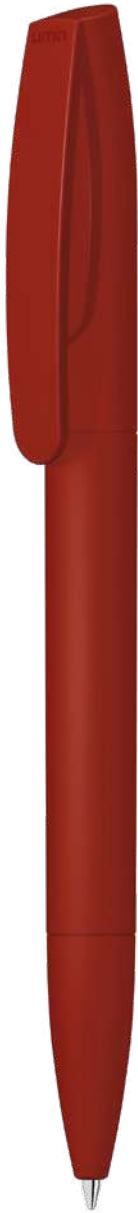

NFC

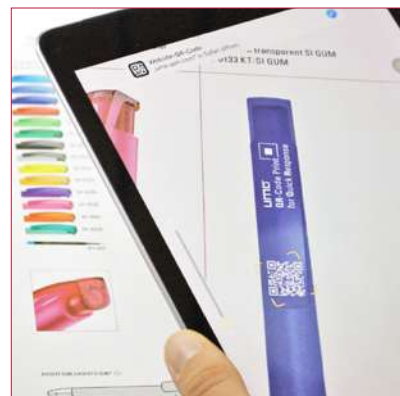

QR-CODE

SKY M SI
0-0125 M-SI
ab Seite/from page 88

STREAM M SI
0-0151 M-SI
ab Seite/from page 98

CHECK M SI
1-0142 M-SI
ab Seite/from page 124



GROOVE TOUCH
0-9530 TO
ab Seite/from page 254

PYRA GUM
0-9733 GUM
ab Seite/from page 244

PYRA M GUM
0-9733 M GUM
ab Seite/from page 244



MESH
0-9350
ab Seite/from page 220

TITAN ONE R
0-9362 R
ab Seite/from page 212

ELEGANCE C
0-9190 C
ab Seite/from page 214

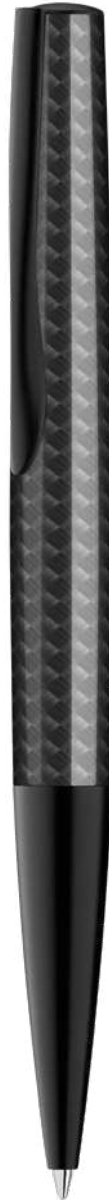



Die Besten noch schneller.

- ▶ 5 Tage Produktionszeit ab Freigabe der Standskizze
- ▶ Bis zu 5-farbig bedruckt (1 Druckstand: Druckarten Siebdruck und Tampondruck sowie Lasergravur)
- ▶ Gütlig für alle Farben der jeweiligen Modellserie
- ▶ 11 Modellserien mit 26 verschiedenen Modellvarianten
- ▶ Kunststoffschreibgeräte, Metallschreibgeräte oder nachhaltige, recycelte PET Schreibgeräte
- ▶ Aufschlag für den umaPRIME Service auf Anfrage



HAPPY
siehe Seite 110-111
see page 110-111

TRINITY
siehe Seite 85
see page 85

ARCTIS
siehe Seite 169
see page 169

UP
siehe Seite 113
see page 113

YES
siehe Seite 105-109
see page 105-109

SKY
siehe Seite 87-88
see page 87-88

UMA[®] PRIME

The best even faster.

- ▶ 5 days production time starting from the day of the confirmed proof
- ▶ Up to 5-color printing (1 printing position: screen printing, pad printing and laser engraving)
- ▶ Valid for all colors of the respective model series
- ▶ 11 model series with 26 different model variants
- ▶ Plastic writing utensils, metal writing utensils or sustainable, recycled PET writing utensils
- ▶ Surcharge for the umaPRIME service on request



STRAIGHT
siehe Seite 239-242
see page 239-242



GROOVE
siehe Seite 255
see page 255



LUMOS
siehe Seite 247
see page 247



VIP
siehe Seite 211
see page 211



HAPPY RECY
siehe Seite 58
see page 58



RECYCLED PET PEN PRO
siehe Seite 28-29
see page 28-29





NATUR
NATURAL

Wir übernehmen Verantwortung

Wir von uma stehen für ein verantwortliches Wirtschaften. Das bedeutet, dass bei uns Werte wie Qualität und Kundenzufriedenheit, wie auch die Einhaltung sozialer Verhaltensweisen und Aspekte der Nachhaltigkeit an oberster Stelle stehen. Auch bei unseren Partnern legen wir höchsten Wert auf menschenwürdige und umweltverträgliche Arbeitsbedingungen, wie beispielsweise die Einhaltung von Arbeitnehmerrechten, das Verbot von Kinder- und Zwangsarbeit sowie den verantwortungsbewussten Umgang mit der Natur und ihren Ressourcen.

Für die Einhaltung dieser Ziele stehen wir mit unserem Namen.

Für unsere gesellschaftliche Verantwortung (CSR) wurden wir von EcoVadis mit der Bronzemedaille ausgezeichnet.



We assume responsibility

For a company focused on the future, it almost goes without saying that quality, service and, by extension, customer loyalty, should always be maintained at the highest level. The holistic viewpoint of any successful company must encompass seamless observance of social modes of behaviour in the daily conduct of its business. The scope of our sense of responsibility extends to the assurance of environmentally compliant working conditions that are truly worthy of our payroll staff. That translates into things like respect for employee rights, the prohibition of child labour and forced labour, as well as a responsible attitude towards our natural world and its resources. We put our name on the line when it comes to achievement of these objectives.

EcoVadis rewarded us with a bronze medal for our corporate social responsibility (CSR).

umaSECRETS

In den umaSECRETS erfahren Sie mehr darüber, wie man bei uma Nachhaltigkeit und soziale Verantwortung nicht nur schreibt, sondern auch lebt. Fordern Sie ihre persönliche Broschüre an oder lesen Sie online im Downloadbereich auf uma-pen.com.

umaSECRETS

With our umaSECRETS you can find out how uma puts sustainability and social responsibility into practice. Order your personal brochure now, or download it online at uma-pen.com.



PEFC- und FSC®-Zertifizierung

Als Produzent aus dem Schwarzwald freut es uns, PEFC- und FSC®-zertifizierte Holzschreibgeräte garantieren zu können und somit zum Schutz von nachhaltigen Rohstoffen beizutragen. Für uns ist es eine Selbstverständlichkeit, an diesem Verfahren zur nachhaltigen Waldbewirtschaftung und zum Schutz eines wichtigen Rohstoffes teilzunehmen.

PEFC garantiert, dass Holz- und Papierprodukte aus nachhaltig bewirtschafteten Wäldern stammen. Mit einer Fläche von über 265 Millionen Hektar zertifizierter Waldfläche garantiert PEFC als größtes Waldzertifizierungssystem weltweit ausreichend Rohstoffmengen. Und rund 1,44 Million Hektar Wald sind in Deutschland FSC® zertifiziert. Dank dieser Zertifizierung übernehmen wir bei uma gesellschaftliche Verantwortung, denn wir unterstützen den verantwortungsbewussten Umgang mit Ressourcen und setzen uns somit für den aktiven Beitrag zum Erhalt der Wälder ein.

PEFC and FSC® certification

As producer in the Black Forest we are happy to present and warranty you PEFC- and FSC®-certified pens made of wood and that we have a share in the prevention of enduring raw materials. For uma Schreibgeräte Ullmann GmbH it is self-evident to take part in the sustainable forest cultivation and for the safety of a very important resource.

PEFC guarantees that wood and paper products made from sustainably managed woods. With an area of over 265 million hectare of certified forest area, PEFC guarantees as the largest forest certification system, sufficient quantities of raw materials are available worldwide. And about 1.44 million hectares German forests are FSC® certificated. Thanks to this certification, uma assumes social responsibility, because we support responsible handling resources and are therefore committed to making an active contribution to the preservation of the forests.

Tradition basiert auf ständigen Innovationen

Bei dem Innovationswettbewerb TOP 100 hat uma es nach 2019 auch in 2022 wieder unter die Besten geschafft. In einem unabhängigen Auswahlverfahren konnten wir besonders mit innovativen Prozessen und innovativem Management nachhaltig punkten. Dass sich zukunftssträchtiges Agieren auch in innovativen Produkten niederschlägt, konnte mit der uma RECYCLED PET PEN-Serie eindrucksvoll bewiesen werden. Der Einsatz alternativer Materialien und die Investition in neue Produktionsverfahren macht uma zu einem der TOP 100 Innovativsten Unternehmen des Deutschen Mittelstandes.



Tradition is based on constant innovation

In the TOP 100 innovation competition, uma made it to the top again in 2022 after 2019. In an independent selection process, we scored particularly well with innovative processes and innovative management. With the uma RECYCLED PET PEN series, it was impressively demonstrated that future-oriented action is also reflected in innovative products. The use of alternative materials and the investment in new production processes make uma one of the TOP 100 most innovative companies in the German medium-sized sector.

uma Produktion ist klimaneutral

Der Klimawandel ist aktuell eine der größten Herausforderungen. Wir wollen Verantwortung übernehmen und leisten einen konkreten Beitrag zum Klimaschutz:

In Zusammenarbeit mit ClimatePartner haben wir die Emissionen unserer Produktserien „Holzschreibgeräte“ und „RECYCLED PET PEN“ berechnet und anschließend über regionale Klimaschutzprojekte ausgeglichen. Somit sind die ersten uma klimaneutralen Schreibgeräte Serien erhältlich.



Wir wären aber nicht uma, wenn wir uns nur auf einen Produkt konzentrieren würden. Aus diesem Grund haben wir die komplette Produktion in Fischerbach, im Herzen des Schwarzwaldes, auf klimaneutral gestellt. Wir freuen uns somit einen positiven Beitrag für die Umwelt leisten zu können.

uma production is climate-neutral

Climate change is currently one of the greatest challenges. We want to assume responsibility and make a concrete contribution to climate protection:

In cooperation with ClimatePartner, we have calculated the emissions of our „Wood Writing Instruments“ and „RECYCLED PET PEN“ product series and then offset them through regional climate protection projects. Thus the first uma climate-neutral writing instruments series are available.



But we wouldn't be uma if we only concentrated on one product. For this reason, we have set the complete production in Fischerbach, in the heart of the Black Forest, to climate-neutral. We are therefore pleased to be able to make a positive contribution to the environment.

uma nachweislich zertifiziert

Die Grundprinzipien unserer Produktionsbedingungen sind klar: Wir sehen es als unternehmerische Verantwortung, menschenwürdige und umweltverträgliche Arbeitsbedingungen sicherzustellen. Somit haben das Einhalten von Arbeitnehmerrechten, sowie der verantwortungsbewusste Umgang mit der Natur und ihren Ressourcen oberste Priorität. Deshalb werden alle uma Produktionsstätten regelmäßig von externen Einrichtungen auditiert und unsere Ansprüche bei persönlichen Besuchen und Briefings den Zulieferern vermittelt. Die Zusammenarbeit mit diesen Produktionsstätten basiert auf jahrelangen und familiären Verbindungen, die ein zusätzliches Sicherheits- und Qualitätsniveau in allen Belangen sicherstellt.

uma demonstrably certified

The basic principles of our production conditions are clear: We see it as our corporate responsibility to ensure humane and environmentally compatible working conditions. Respect for workers' rights and the responsible use of nature and its resources are therefore our top priorities. Therefore, all uma production sites are regularly audited by external institutions and our requirements are communicated to the suppliers during personal visits and briefings. The cooperation with these production sites is based on long-standing and family ties, which ensure an additional level of safety and quality in all matters.





Etui Empfehlung / Case suggestion
ETUI 0-0940 Cl rPET
Seite / page 296

0-2210 F (● 8-0854)

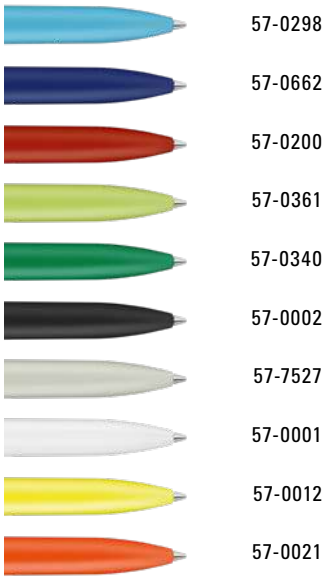

0-2210 TF (● 8-0854)



Aufgrund der Besonderheiten des Materials (recyceltes PET-Material) sind produktionstechnische Farbschwankungen gegeben.
Due to the special nature of the material (recycled PET material) production-related variations are possible.



Das aus recycelten PET-Flaschen in Europa hergestellte rPET-Material eignet sich für einen langlebigen und nachhaltigen Werbeeinsatz. Dank der europäischen und klimaneutralen Produktion leistet der uma RECYCLED PET PEN STEP einen zusätzlichen nachhaltigen Beitrag zur Schonung der Umwelt.

The rPET material, which is produced in Europe from recycled PET bottles, is suitable for a durable and sustainable advertisement. Thanks to the European and climate-neutral production, the uma RECYCLED PET PEN STEP makes an additional sustainable contribution to the protection of the environment.

Mix n' Match: Ab 2.000 Stück kann das Modell farblich kombiniert werden.
0-2210 F: Druckkugelschreiber aus recyceltem PET-Material mit matt gedecktem Gehäuse, Clip und Drücker.

Mix n' Match: From 2,000 pieces, you can choose any colour combination.
0-2210 F: Retractable ballpoint pen made from recycled PET material with opaque matt housing, clip and push-button.

0-2210 TF: Druckkugelschreiber aus recyceltem PET-Material mit transparent gefrostetem Gehäuse, Clip und Drücker.

0-2210 TF: Retractable ballpoint pen made from recycled PET material with transparent frosted housing, clip and push-button.

Mindestbestellmenge 1.000 Stück
Werbeschlüssel Schaft S, Clip T

Minimum quantity 1,000 pieces
Advertising code barrel S, clip T

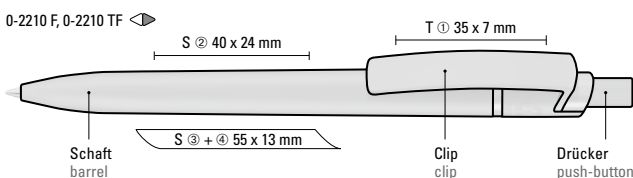

RECYCLED PET PEN PRO
0-2250

RECYCLED PET PEN PRO F
0-2250 F

Farb-Code/Minen
Colour code/Refills



Aufgrund der Besonderheiten des Materials (recyceltes PET-Material) sind produktionstechnische Farbschwankungen gegeben.

Due to the special nature of the material (recycled PET material) production-related variations are possible.

UMA[®]
PRIME



0-2250 (● 8-0854)
0-2250 F (● 8-0854)

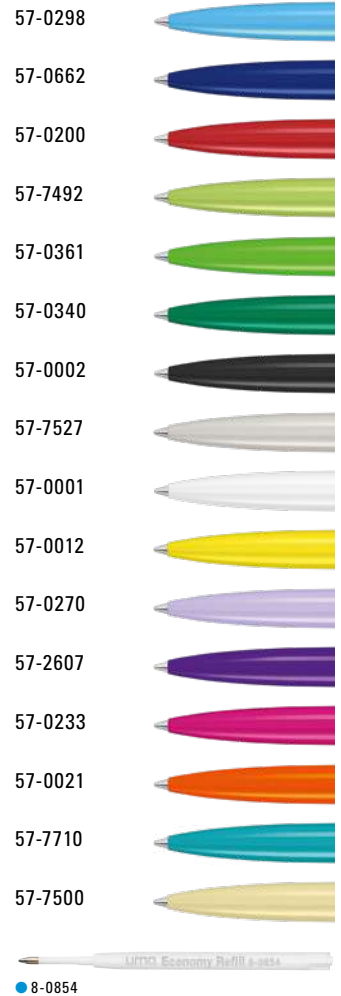

Das aus recycelten PET-Flaschen in Europa hergestellte rPET-Material eignet sich für einen langlebigen und nachhaltigen Werbeeinsatz. Dank der europäischen und klimaneutralen Produktion leistet der uma RECYCLED PET PEN PRO einen zusätzlichen nachhaltigen Beitrag zur Schonung der Umwelt.

Mix n' Match: Ab 2.000 Stück kann das Modell farblich kombiniert werden.

0-2250: Druckkugelschreiber aus recyceltem PET-Material mit gedeckt glänzendem Gehäuse und Clip.

0-2250 F: Druckkugelschreiber aus recyceltem PET-Material mit matt gedecktem Gehäuse und Clip.

Mindestbestellmenge 1.000 Stück
Werbeschlüssel Schaft S, Clip T

The rPET material, which is produced in Europe from recycled PET bottles, is suitable for a durable and sustainable advertisement. Thanks to the European and climate-neutral production, the uma RECYCLED PET PEN PRO makes an additional sustainable contribution to the protection of the environment.

Mix n' Match: From 2,000 pieces, you can choose any colour combination.

0-2250: Retractable ballpoint pen made from recycled PET material with opaque glossy housing and clip.

0-2250 F: Retractable ballpoint pen made from recycled PET material with opaque matt housing and clip.

Minimum quantity 1,000 pieces
Advertising code barrel S, clip T



0-2250, 0-2250 F ◀

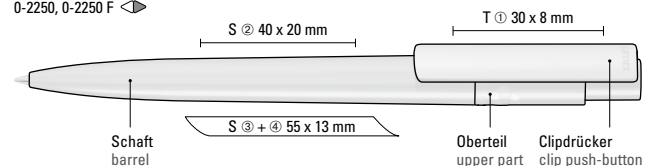

0-2250 T (● 8-0854)
0-2250 TF (● 8-0854)



Aufgrund der Besonderheiten des Materials (recyceltes PET-Material) sind produktionstechnische Farbschwankungen gegeben.
Due to the special nature of the material (recycled PET material) production-related variations are possible.



Etui Empfehlung/Case suggestion
ETUI 0-0955 rPET
Seite/page 297



Das aus recycelten PET-Flaschen in Europa hergestellte rPET-Material eignet sich für einen langlebigen und nachhaltigen Werbeeinsatz. Dank der europäischen und klimaneutralen Produktion leistet der uma RECYCLED PET PEN PRO einen zusätzlichen nachhaltigen Beitrag zur Schonung der Umwelt.

The rPET material, which is produced in Europe from recycled PET bottles, is suitable for a durable and sustainable advertisement. Thanks to the European and climate-neutral production, the uma RECYCLED PET PEN PRO makes an additional sustainable contribution to the protection of the environment.

Mix n' Match: Ab 2.000 Stück kann das Modell farblich kombiniert werden.

Mix n' Match: From 2,000 pieces, you can choose any colour combination.

0-2250 T: Druckkugelschreiber aus recyceltem PET-Material mit transparent glänzendem Gehäuse und Clip.

0-2250 T: Retractable ballpoint pen made from recycled PET material with transparent housing and clip.

0-2250 TF: Druckkugelschreiber aus recyceltem PET-Material mit transparent gefrostetem Gehäuse und Clip.

0-2250 TF: Retractable ballpoint pen made from recycled PET material with transparent frosted housing and clip.

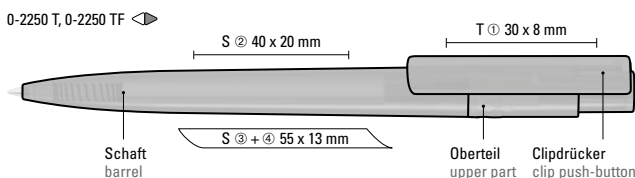

Mindestbestellmenge 1.000 Stück
Werbeschlüssel Schaft S, Clip T

Minimum quantity 1,000 pieces
Advertising code barrel S, clip T

Wie schreibt man „nachhaltig“?

Nachhaltigkeit – ein Thema, das uma schon seit vielen Jahren bewegt, dies spiegelt sich nicht nur in unserer generationsübergreifenden und zukunftsorientierten Firmengeschichte wider, sondern auch in den innovativen uma Produktideen. Mit den uma RECYCLED PET PEN-Serien haben wir die erste tatsächlich nachhaltige Schreibgeräte-Serie entwickelt, die nicht nur in Haptik und Variationsmöglichkeit, sondern auch mit einer innovativen Recyclingidee überzeugt.



How do you write 'sustainably'?

Sustainability – a topic that has been on uma's agenda for many years. This is reflected not only in our generation-spanning and future-oriented company history, but also in the innovative uma product ideas. With the uma RECYCLED PET PEN series we have developed the first truly sustainable writing instrument series, which not only convinces in haptics and variation possibilities, but also with an innovative recycling idea.



Die uma RECYCLED PET PEN-Serie

Schreiben Sie mit der ersten in Europa gefertigten, komplett klimaneutralen, recycelten, nachhaltigen Schreibgeräte-Serie. Die uma RECYCLED PET PEN-Serie.

Mit Innovationen Werben

Die verschiedenen Schreibsysteme, neben dem klassischen Kugelschreiber, basieren alle auf einem eigens entwickelten und innovativen Tintenleitsystem. Die Patronen können in allen Schreibgeräten ausgewechselt und nachgerüstet werden. Langlebiges Schreiben und Werben ist somit garantiert. Die Kombination aus Schreibsystemen und recyceltem PET Material macht die uma RECYCLED PET PEN-Serie zu einer Weltneuheit. Die erste nachhaltige Schreibgeräte-Serie aus recyceltem PET Material, die komplett klimaneutral produziert wird, verleiht den werbenden Unternehmen in der Kommunikation nicht nur Nachhaltigkeit, sondern auch geschriebene Innovation. Die nachhaltige Schreibgeräte-Familie, uma RECYCLED PET PEN verspricht Werbekommunikation und Schreibvergnügen auf höchstem Niveau.

The uma RECYCLED PET PEN series

Write with the first European, climate-neutral, recycled and sustainable produced writing instrument series. The uma RECYCLED PEN PEN series.

Advertising with innovations

Along with the classic ballpoint pen, the various writing systems are all based on a specially developed and innovative ink flow system. The cartridges can be used and retrofitted. This guarantees long-lasting writing joy and appeal. The combination of writing systems and recycled PET material makes the uma RECYCLED PET PEN series a world first. The first sustainable writing series made from recycled PET material, which is produced completely climate-neutral, gives companies looking to communicate attractively sustainable and written innovation. The sustainable uma RECYCLED PET PEN series guarantees promotional communication and an enjoyable writing experience of the highest quality.



Schreiben auch Sie Verantwortung! / Communicate your responsibility too!

Schreiben Sie die uma RECYCLED PET PEN-Serie mit folgenden Pro-Argumenten
Communicate the uma RECYCLED PET PEN series with the following pro arguments

 <ul style="list-style-type: none"> • Weltneuheit: Erste in Europa gefertigte, recycelte, komplett klimaneutrale Schreibgeräte-Serie aus rPET Material. • Ein Recyclingprozess wurde bereits durchlaufen. • World first: First recycled, fully climate-neutral writing series produced from rPET material and made in Europe. • Already undergone a recycling process. 	 <ul style="list-style-type: none"> • rPET Material zu 100 % aus recycelten PET Flaschen • Eine 0,5 L PET Flasche ergibt genau ein Schreibgerätegehäuse. • Langlebiges, nachhaltiges Material – eignet sich zum Upcycling. • rPET material made 100 % from recycled PET bottles. • One 0,5 l PET bottle produces exactly one housing of a pen. • Long-lasting, sustainable material – suitable for upcycling.
 <ul style="list-style-type: none"> • Es werden ausschließlich PET Flaschen aus Europa verwendet (ausser Ocean Bound Plastic). • Made in Europe. • Only PET bottles from Europe are used (except ocean-bound plastic). • Made in Europe. 	 <ul style="list-style-type: none"> • Optimaler CO₂-Fußabdruck. • Komplett klimaneutrale Produktion und Veredelung. • Low carbon footprint. • Fully climate-neutral production and processing.
 <ul style="list-style-type: none"> • Alle Schreibgeräte sind mit dem international bekannten „rPET RECY-Zeichen“ versehen. • Kann einem weiteren Recyclingprozess zugeführt werden. • All stationery features the internationally recognised “rPET RECY logo” . • Can be recycled further. 	 <ul style="list-style-type: none"> • Designs auch als antimikrobielle Variante erhältlich, zertifiziert nach ISO 22196-2011. • #gesundbleiPEN – Hygiene und Nachhaltigkeitskonzept werden mit einem Schreibgerät erfüllt. • Designs also available as antimicrobial version, certified according to ISO 22196-2011. • #antibacterial – hygiene and sustainability concept are fulfilled with one writing instrument.



- Einzigartige Gehäusefarbpalette, zusätzliche Einfärbung nach PMS und Mix & Match-Service.
- Unique housing colour range, additional colouring based on PMS and Mix & Match service.



Vier Schreibsysteme ein Design

- **Kugelschreiber** mit Dokumental® Schreibpaste ●●
- **Rollerball** ●●●●●●●●●●
- **Highlighter** mit Dokumental® Highlighterpaste, EN-71-3, ASTM D4326 ●●●●●●●●
- **Fineliner** mit Dokumental® Finelinerpaste, EN-71-3, ASTM D4326 ●●●●●●●●●●

Four writing systems one design

- **Ballpoint pen** with Dokumental® writing ink ●●
- **Rollerball** ●●●●●●●●●●
- **Highlighter** with Dokumental® highlighter ink, EN-71-3, ASTM D4326 ●●●●●●●●
- **Fineliner** with Dokumental® finelinerpaste, EN-71-3, ASTM D4326 ●●●●●●●●●●



- Geschlossener und kontrollierter Recycling- bzw. Produktionsprozess nach dem „Global Recycling Standard“ zertifiziert.
- Zertifizierte und Ausgezeichnete Idee.
- Closed and controlled recycling and production process certified based on the “Global Recycling Standard”.
- Certified and award-winning concept.



Nachhaltigkeit kombiniert mit innovativer Schreibtechnologie – Das uma Tintenleitsystem

Dank der innovativen Weiterentwicklung der uma RECYCLED PET PEN PRO-Serie ergeben sich zusätzliche Varianten von Schreibsystemen und Werbeoptionen für den Kunden.

Neben dem klassischen Kugelschreiber können weitere Schreibsysteme im identischen Design, aus recyceltem PET-Material mit den gleichen Nachhaltigkeitsvorteilen umgesetzt werden.

Sustainably combined with innovative writing technology – The uma ink flow system

Thanks to the innovative further development of the uma RECYCLED PET PEN PRO series, additional types of writing system and promotional options have been created for customers.

Along with the classic ballpoint pen, other identical writing systems made from recycled PET material can be used with the same sustainability benefits.



So schreiben Sie ab sofort Nachhaltigkeit auch mit dem uma Highlighter:

RECYCLED PET PEN PRO LIQEO

Textmarker sind aus dem täglichen Bürobedarf nicht mehr wegzudenken. Somit sind die Highlighter in 6 Schreibfarben sowohl für den internen Gebrauch, aber auch für die Abgabe als Werbe- und Kommunikationstool perfekt. Auch im Bereich Schule, Ausbildungsmessen oder Mitarbeiterrekrutierung können diese Modelle optimal eingesetzt werden.

Now you can write sustainably with the uma highlighter:

RECYCLED PET PEN PRO LIQEO

Text markers are an essential office item. Thus, the highlighters in 6 writing colours are suitable for office use and as an advertising and communication tool. These models can be optimally used in schools, at training fairs or employee recruitment.



RECYCLING PET PEN PRO LIQEO

0-2255

Seite/page 35

Spüren Sie nachhaltigen Schreibgenuss auch mit dem uma Rollerball:

RECYCLED PET PEN PRO Rollerball

Ein Rollerball für den besonders feinen Strich. In der uma RECYCLED PET PEN PRO-Serie gleich in 8 Schreibfarben erhältlich. Unterschriften für Verträge oder für ein einfach schönes Schreibgefühl ergeben weitere Werbeeinsatzmöglichkeiten.

Experience the enjoyment of sustainable writing with the uma rollerball:

RECYCLED PET PEN PRO Rollerball

A rollerball for a particularly fine line. Available in 8 writing colours in the uma RECYCLED PET PEN PRO series. Signing contracts or for a simply exquisite writing experience result in additional promotional opportunities.



RECYCLING PET PEN PRO Roller
0-2252 R
 Seite/page 34

Bringen Sie zukunftsorientierte Entwicklungen auf den Punkt mit dem uma Fineliner:

RECYCLED PET PEN PRO Fineliner

Unterstreichen, hervorheben oder technisches Zeichnen, mit einem Fineliner kann der dünne Strich nicht nur präzise, sondern auch in Farbe umgesetzt werden. In der uma RECYCLED PET PEN PRO-Serie geht das mit 12 Standardfarben.

Get to the heart of future-oriented developments with the uma fineliner:

RECYCLED PET PEN PRO Fineliner

Emphasise, highlight or technical drawing – the thin streak of a fineliner can be precisely presented in colour format. 12 standard colours are available in the uma RECYCLED PET PEN PRO series.



RECYCLING PET PEN PRO Fineliner
0-2254 FL
 Seite/page 34

RECYCLED PET PEN PRO R
0-2252 R

RECYCLED PET PEN PRO FL
0-2254 FL

Farb-Code/Minen
Colour code/Refills

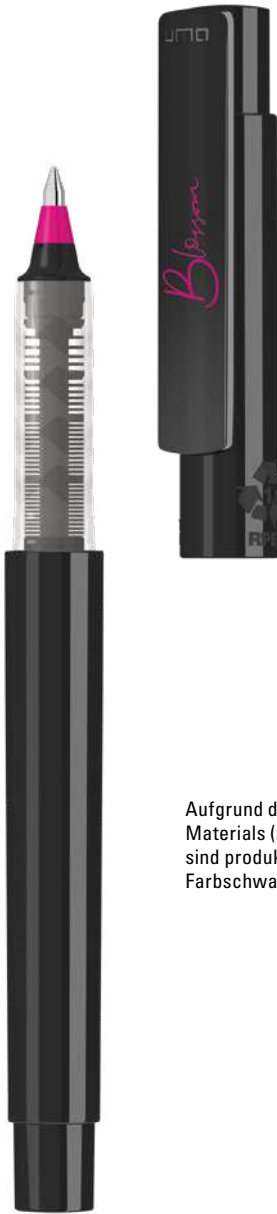

Aufgrund der Besonderheiten des Materials (recycltes PET-Material) sind produktionstechnische Farbschwankungen gegeben.



Das aus recycelten PET-Flaschen in Europa hergestellte rPET-Material eignet sich für einen langlebigen und nachhaltigen Werbeinsatz. Dank der europäischen und klimaneutralen Produktion leistet der RECYCLED PET PEN PRO einen zusätzlichen nachhaltigen Beitrag zur Schonung der Umwelt.

0-2252 R: Rollerball mit Gehäuse aus recyceltem PET-Material in gedeckt glänzend weiß oder schwarz. Stopfen in den 8 möglichen Schreibfarben.

0-2254 FL: Fineliner mit Gehäuse aus recyceltem PET-Material in gedeckt glänzend weiß oder schwarz. Stopfen in den 12 möglichen Schreibfarben.

Mindestbestellmenge 1.000 Stück
Werbeschlüssel Schaft S, Clip T, Kappe T

The rPET material, which is produced in Europe from recycled PET bottles, is suitable for a durable and sustainable advertisement. Thanks to the European and climate-neutral production, the RECYCLED PET PEN PRO makes an additional sustainable contribution to the protection of the environment.

0-2252 R: Rollerball with opaque glossy housing in white or black made from recycled PET material. Plug in 8 possible writing colours.

0-2254 FL: Fineliner with opaque glossy housing in white or black made from recycled PET material. Plug in 12 possible writing colours.

Minimum quantity 1,000 pieces
Advertising code barrel S, clip T, cap T



0-2252 R



0-2254 FL



0-2252 R

57-0002



57-0001



Tintenleitsystem/ink flow system

57-0298



57-0662



57-0200



57-0361



57-0002



57-2607



57-0233



57-0021



0-2254 FL

57-0002



57-0001

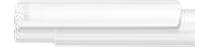

Tintenleitsystem/ink flow system

57-0298



57-0662



57-0200



57-7492



57-0361



57-0002



57-7527



57-0012



57-2607



57-0233



57-0021



57-0478



0-2252 R, 0-2254 FL

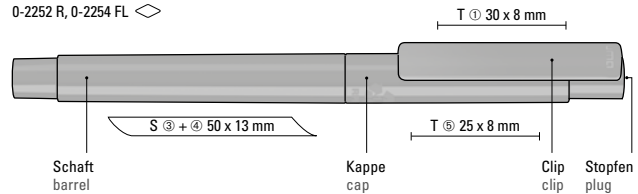

- 0-2255
- 57-0002
- 57-0001
- Tintenleitsystem/ink flow system
- 57-0801
- 57-0802
- 57-0930
- 57-0814
- 57-0806
- 57-0804



0-2255



Due to the special nature of the material (recycled PET material) production-related variations are possible.



Das aus recycelten PET-Flaschen in Europa hergestellte rPET-Material eignet sich für einen langlebigen und nachhaltigen Werbeeinsatz. Dank der europäischen und klimaneutralen Produktion leistet der uma RECYCLED PET PEN PRO einen zusätzlichen nachhaltigen Beitrag zur Schonung der Umwelt.

The rPET material, which is produced in Europe from recycled PET bottles, is suitable for a durable and sustainable advertisement. Thanks to the European and climate-neutral production, the uma RECYCLED PET PEN PRO makes an additional sustainable contribution to the protection of the environment.

0-2255: Flüssig-Textmarker mit Gehäuse aus recyceltem PET-Material in gedeckt glänzend weiß oder schwarz. Stopfen in den 6 möglichen Schreibfarben. Der Highlighter ist ohne Pumpen oder Anstechen sofort einsatzfähig. Neues Flüssigtintenleitsystem – Bessere Schreibqualität – Höhere Leuchtkraft – Längere Schreibdauer – Umweltfreundlicher – Produziert nach EN-71, ASTM D-4236, Flüssigtank austausch- bzw. nachfüllbar.

0-2255: Liquid highlighter with opaque glossy housing in white or black made from recycled PET material. Plug in 6 possible writing colours. Writes longer and more intensive as conventional highlighter, is without pumping or tapping operational immediately, supported in this way the sustainability concept. New liquid ink delivery system – better writing quality – greater luminance – longer writing time – ecologically superior – produced in acc. with EN-71, ASTM D-4236, liquid tank replaceable or refillable.

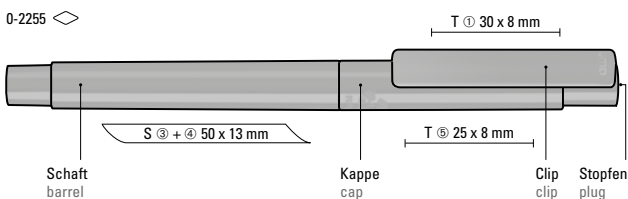

Mindestbestellmenge 1.000 Stück
Werbeschlüssel Schaft S, Clip T, Kappe T

Minimum quantity 1,000 pieces
Advertising code barrel S, clip T, cap T

RECYCLED PET PEN PRO SI

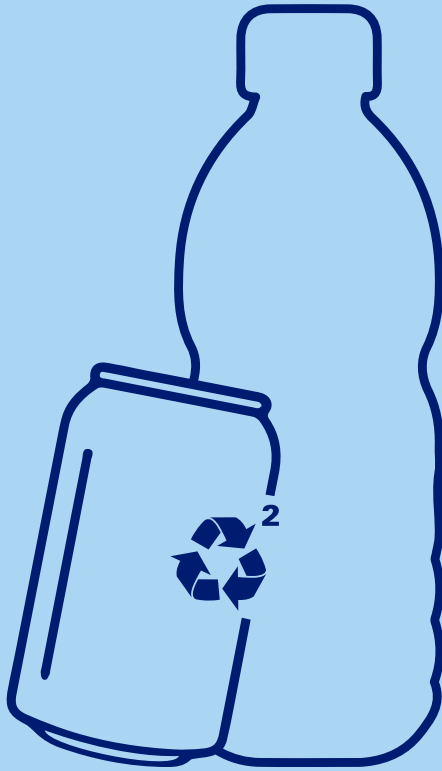

sustainable
RECYCLED²
 INNOVATIVE

RECYCLED PET PEN PRO SI Recycled² – die nachhaltigste Kombination in einem Schreibgerät!

Recycelte PET-Getränke Flaschen treffen auf recycelte Aluminium Getränkedosen. Die uma rPET PRO Serie ist eine der nachhaltigsten Schreibgeräteentwicklungen der Werbebranche. Eine 100 % klimaneutrale, europäische und nach Global Recycled Standard zertifizierte Produktion bilden die Basis für langlebiges und nachhaltiges Schreiben. Die neue Upcycling-Idee erweitert die bisher reine recycelte PET-Schreibgeräteserie um schicke Metallapplikationen. Aus einer recycelten Aluminium 150 ml Getränkedose entstehen 10 wertige Metallspitzen, die auf ein PET-Gehäuse einer recycelten 0,5 l PET-Flasche treffen. So schreiben Sie mit dem uma RECYCLED PET PEN PRO SI die nachhaltigste Kombination für die Umwelt – eben: uma Recycled².

RECYCLED PET PEN PRO SI Recycled² – the most sustainable combination in a writing instrument!

Recycled PET beverage bottles meet recycled aluminium beverage cans. The uma rPET PRO series is one of the most sustainable writing instrument developments in the promotional industry. A 100 % climate-neutral, European and Global Recycled Standard certified production built up the basics for long-lasting and sustainable writing. The new upcycling idea adds elegant metal applications to the previously pure recycled PET writing instrument series. A recycled aluminium 150ml beverage can is recycled into 10 valuable metal tips that meet a PET housing of a recycled 0.5 l PET bottle. So with the uma RECYCLED PET PEN PRO SI you write the most sustainable combination for the environment – just: uma Recycled².



Produkt-Video/product video
 RECYCLED PET PEN PRO SI

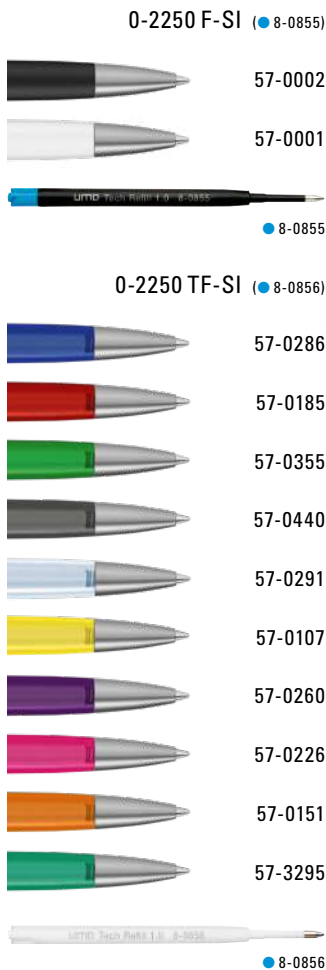

Aufgrund der Besonderheiten des Materials (recyceltes PET-Material) sind produktionstechnische Farbschwankungen gegeben.

Due to the special nature of the material (recycled PET material) production-related variations are possible.

Die Gewinnung und Verarbeitung des rPET-Materials aus 100% recycelten PET-Flaschen sowie das rALU-Material aus 100% recycelten Aluminium-Getränkedosen findet in Europa statt. Die beiden Materialien eignen sich für einen langlebigen und nachhaltigen Werbeinsatz. Dank der europäischen und klimaneutralen Produktion leistet der uma RECYCLED PET PEN PRO einen zusätzlichen nachhaltigen Beitrag zur Schonung der Umwelt.

The extraction and processing of the rPET material from 100% recycled PET bottles, as well as the rALU material from 100% recycled aluminium beverage cans takes place in Europe. Both materials are suitable for a durable and sustainable advertisement. Thanks to the European and climate-neutral production, the uma RECYCLED PET PEN PRO makes an additional sustainable contribution to the protection of the environment.

Mix n' Match: Ab 2.000 Stück kann das Modell farblich kombiniert werden.

0-2250 F-SI: Druckkugelschreiber aus recyceltem PET-Material mit matt gedecktem Gehäuse und Clip sowie Metallspitze aus recyceltem Aluminium in silber matt.

0-2250 TF-SI: Druckkugelschreiber aus recyceltem PET-Material mit transparent gefrostetem Gehäuse und Clip sowie Metallspitze aus recyceltem Aluminium in silber matt.

Mindestbestellmenge 1.000 Stück
Werbeschlüssel Schaft S, Clip T

Mix n' Match: From 2,000 pieces, you can choose any colour combination.

0-2250 F-SI: Retractable ballpoint pen made from recycled PET material with opaque matt housing and clip, metal tip made from recycled aluminium in matt silver.

0-2250 TF-SI: Retractable ballpoint pen made from recycled PET material with transparent frosted housing and clip, metal tip made from recycled aluminium in matt silver.

Minimum quantity 1,000 pieces
Advertising code barrel S, clip T

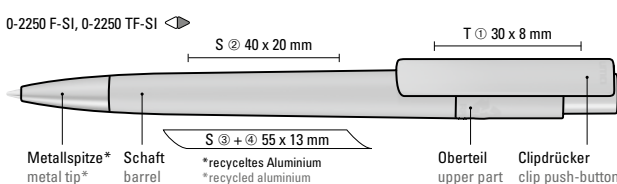

RECYCLED PET PEN PRO ocean



made from ocean-bound plastic



Produkt-Video/
product video

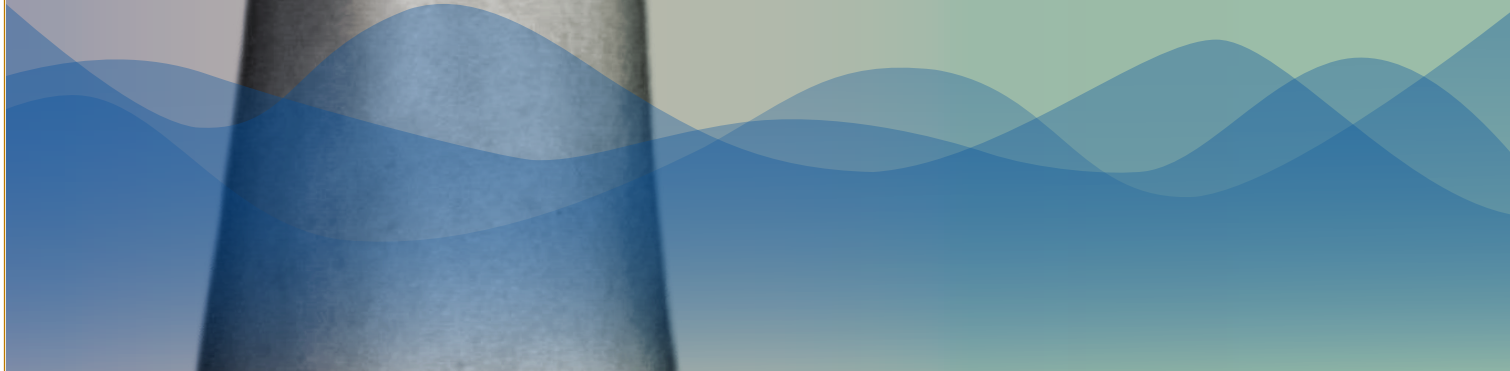

0-2250 F OCEAN (● 8-0854)



Etui Empfehlung/Case suggestion
ETUI 0-0940 CI
Seite/page 296



Aufgrund der Besonderheiten des Materials (recycltes PET-Material) sind produktionstechnische Farbschwankungen gegeben.
Due to the special nature of the material (recycled PET material) production-related variations are possible.

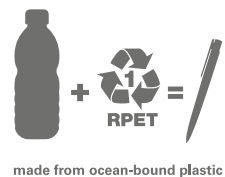

Das durch Plastic Bank gesammelte Ocean Bound Plastic, auch bekannt als Social Plastic®, wird in Europa zu einem recycelten PET Schreibgerät für einen langlebigen und nachhaltigen Werbeeinsatz upgecycelt. Dank der europäischen und klimaneutralen Produktion leistet der uma RECYCLED PET PEN PRO ocean einen zusätzlichen nachhaltigen Beitrag zur Schonung der Umwelt.

Ocean-bound plastic, also known as Social Plastic®, collected through Plastic Bank is upcycled in Europe into a recycled PET writing instrument for long-lasting and sustainable advertisement. Thanks to the European and climate-neutral production, the uma RECYCLED PET PEN PRO ocean makes an additional sustainable contribution to the protection of the environment.

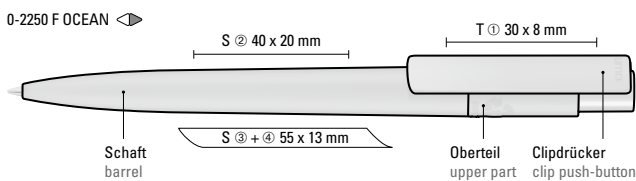

Mix n' Match: Ab 2.000 Stück kann das Modell farblich kombiniert werden.

0-2250 F OCEAN: Druckkugelschreiber aus recyceltem PET-Material aus Ocean Bound Plastic mit matt gedecktem Gehäuse und Clip.

Mix n' Match: From 2,000 pieces, you can choose any colour combination.

0-2250 F OCEAN: Retractable ballpoint pen made of ocean-bound PET material with opaque matt housing and clip.

Mindestbestellmenge 1.000 Stück
Werbeschlüssel Schaft S, Clip T

Minimum quantity 1,000 pieces
Advertising code barrel S, clip T



ANTIBAKTERIELL UND ANTIVIRAL

Der antimikrobielle Zusatz verleiht dem rPET eine antibakterielle und antivirale Wirkung.

Die antimikrobielle Wirkung ist für die gesamte Lebensdauer des Schreibgerätes gewährleistet und bietet somit einen dauerhaften Schutz.



GEPRÜFT UND ZERTIFIZIERT

Die Haftung und Ansiedelung von Krankheitserregern auf der Oberfläche des Schreibgerätes wird nachweislich zu 99,99% reduziert.

Geprüft nach ISO 21702 (antiviral) und ISO 22196 (antibakteriell). Sowohl Bakterien als auch Viren (auch das Corona Virus) werden vernichtet.



MADE IN EUROPE

Kurze und schnelle Lieferwege ermöglichen eine zuverlässige und kurzfristige Produktion und schaffen einen zusätzlichen Beitrag zum Erhalt der Umwelt.



KLIMANEUTRAL

Die Schreibgeräte werden in Europa produziert und klimaneutral veredelt. Auf diese Weise wird ein zusätzlich positiver Beitrag für die Umwelt geleistet.



RECYCELTE

Das Gehäuse wird zu 100% aus recycelten PET-Flaschen hergestellt. Somit wurde bereits ein Recycling-Prozess umgesetzt und das Produkt kann wieder dem Recyclingzyklus zugeführt werden.

ANTIBACTERIAL AND ANTIVIRAL

It is made of antibacterial and antiviral plastic containing a special additive which prevents bacteria from colonising the surface of the pen.

TESTED AND CERTIFIED

Laboratory tests have shown that up to 99.99% of bacteria and pathogens on the surface of writing instruments are eliminated. Tested according to ISO 21702 (antiviral) and ISO 22196 (antibacterial) effect is guaranteed for the entire life of the writing instrument and thus offers lasting protection.

MADE IN EUROPE

Short and fast delivery routes enable reliable and short-term production and create an additional contribution to the preservation to the environment.

CLIMATE NEUTRAL

The writing instruments are produced in Europe and finished climate-neutral in the Black Forest. In this way, an additional positive contribution to the environment is made.

RECYCLED

The barrel is made of 100% recycled PET bottles. With the use of uma RECYCLED PET PENs we assure you that a recycling process has already been supported and that the writing instruments can be fed into further recycling cycles.



Etui Empfehlung / Case suggestion

0-0940 CI ANTIBAC

Pappstecketui aus FSC®-zertifiziertem Pappkarton für ein Schreibgerät mit aufgedruckter Erklärung zum uma RECYCLED PET PEN PRO antibacterial, siehe Seite 297.

Cardboard slip-in case made of FSC® certified cardboard for one writing instrument with printed declaration of uma RECYCLED PET PEN PRO antibacterial, see on page 297.

0-2250 ANTIBAC (● 8-0854)	
	57-0298
	57-0662
	57-0200
	57-7492
	57-0361
	57-0002
	57-7527
	57-0001
	57-0012
	57-0021
	57-7710
	● 8-0854

- ANTIBAKTERIELL
- ANTIVIRAL
- RECYCELT
- KLIMANEUTRAL



Wirkt gegen Corona - Viren

Das aus recycelten PET-Flaschen in Europa hergestellte rPET-Material eignet sich für langlebigen und nachhaltigen Werbeeinsatz. Der uma RECYCLED PET PEN PRO antibacterial bietet gleichzeitig mehrere Verkaufsargumente: recycelt, umweltverträglich, klimaneutral, antibakteriell und antiviral.

Aufgrund der Besonderheiten des Materials (recyceltes PET-Material) sind produktionstechnische Farbschwankungen gegeben.

The rPET material, which is produced in Europe from recycled PET bottles, is suitable for a durable and sustainable advertisement. The uma RECYCLED PET PEN PRO antibacterial offers several sales arguments: recycled, environmentally friendly, climate-neutral, antibacterial and antiviral.

Due to the special nature of the material (recycled PET material) production-related variations are possible.



Mix n' Match: Ab 2.000 Stück kann das Modell farblich kombiniert werden.

0-2250 ANTIBAC: Druckkugelschreiber aus recyceltem, antibakteriellem und antiviralem rPET in gedeckt glänzendem Gehäuse und Clip. Der nach ISO 22196 und ISO 21702 geprüfte antimikrobielle Zusatz verleiht dem rPET eine antibakterielle und antivirale Wirkung auch gegen Corona-Viren. Die Haftung und Ansiedlung von Bakterien oder Krankheitserregern auf der Oberfläche des Schreibgerätes wird um 99,99% verringert. Der in das rPET Material eingearbeitete antimikrobielle Zusatz kann nicht abgerieben oder abgegeben werden und wirkt über die gesamte Lebensdauer des Schreibgerätes. Eine dauerhafte Reduzierung von Krankheitserregern ist gegeben.

Mix n' Match: From 2,000 pieces, you can choose any colour combination.

0-2250 ANTIBAC: Retractable ballpoint pen made from recycled, antibacterial and antiviral recycled PET material with opaque glossy housing and clip. The ISO 22196 and ISO 21702 tested antimicrobial additive of silver ions gives the rPET material an antibacterial and antiviral effect that reduces the adhesion and settling of bacteria or pathogens on the surface of the writing instrument by 99.99%. The antimicrobial additive incorporated into the rPET material cannot be rubbed off or released and is effective over the entire life of the writing instrument. A permanent reduction of pathogens is given.

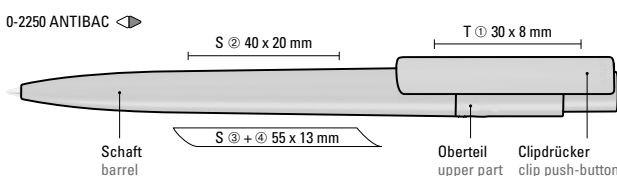

Mindestbestellmenge 1.000 Stück
Werbeschlüssel Schaft S, Clip T

Minimum quantity 1,000 pieces
Advertising code barrel S, clip T



0-2250 F TO (● 8-0854)



Aufgrund der Besonderheiten des Materials (recyceltes PET-Material) sind produktionstechnische Farbschwankungen gegeben.

Due to the special nature of the material (recycled PET material) production-related variations are possible.



Das aus recycelten PET-Flaschen in Europa hergestellte rPET-Material eignet sich für einen langlebigen und nachhaltigen Werbeeinsatz. Dank der europäischen und klimaneutralen Produktion leistet der uma RECYCLED PET PEN PRO F TOUCH einen zusätzlichen nachhaltigen Beitrag zur Schonung der Umwelt.

The rPET material, which is produced in Europe from recycled PET bottles, is suitable for a durable and sustainable advertisement. Thanks to the European and climate-neutral production, the uma RECYCLED PET PEN PRO F TOUCH makes an additional sustainable contribution to the protection of the environment.

0-2250 F TO: Druckkugelschreiber aus recyceltem PET-Material mit matt gedecktem Gehäuse und silbernem Clip, Drücker mit integrierter Touchscreensteuerung.

0-2250 F TO: Retractable ballpoint pen made from recycled PET material with opaque matt housing and silver clip, push-button with integrated touch screen control.

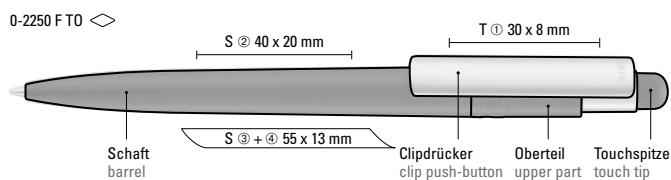

Mindestbestellmenge 1,000 Stück
Werbeschlüssel Schacht S, Clip T

Minimum quantity 1,000 pieces
Advertising code barrel S, clip T



RECYCLED PET PEN ALUMA



Die Gewinnung und Verarbeitung des rPET Materials aus 100% recycelten PET-Flaschen sowie das rALU-Material aus 100% recycelten Aluminium-Getränkedosen findet in Europa statt. Die beiden Materialien eignen sich für einen langlebigen und nachhaltigen Werbeeinsatz. Dank der europäischen und klimaneutralen Produktion leistet der uma RECYCLED PET PEN ALUMA transparent einen zusätzlichen nachhaltigen Beitrag zur Schonung der Umwelt.

Aufgrund der Besonderheiten des Materials (recyceltes PET-Material) sind produktionstechnische Farbschwankungen gegeben.

The extraction and processing of the rPET material from 100% recycled PET bottles, as well as the rALU material from 100% recycled aluminium beverage cans takes place in Europe. Both materials are suitable for a durable and sustainable advertisement. Thanks to the European and climate-neutral production, the uma RECYCLED PET PEN ALUMA makes an additional sustainable contribution to the protection of the environment.

Due to the special nature of the material (recycled PET material) production-related variations are possible.

0-7200 (● 8-0855)
0-7200 T (● 8-0856)

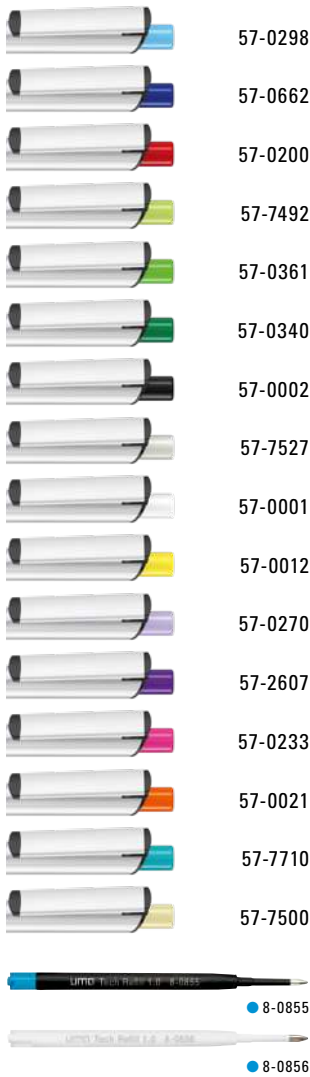

Die Modelle eignen sich für eine
Lasierung in weiß.
The models are suitable for
laser engraving in white.



0-7200: Metall-Druckkugelschreiber mit Metallspitze, Metallschaft und Metallclip aus recyceltem Aluminium, Kunststoffteile aus recyceltem PET-Material in gedeckt schwarz und gedeckt farbigem Drücker.

0-7200 T: Metall-Druckkugelschreiber mit Metallspitze, Metallschaft und Metallclip aus recyceltem Aluminium, Kunststoffteile aus recyceltem PET-Material in klar transparent und gedeckt farbigem Drücker.

0-7200: Metal retractable ballpoint pen with metal tip, metal barrel and metal clip made from recycled aluminium in matt silver, plastic parts made from recycled PET material in opaque glossy black and opaque coloured push-button.

0-7200 T: Metal retractable ballpoint pen with metal tip, metal barrel and metal clip made from recycled aluminium in matt silver, plastic parts made from recycled PET material in opaque clear transparent and opaque coloured push-button.

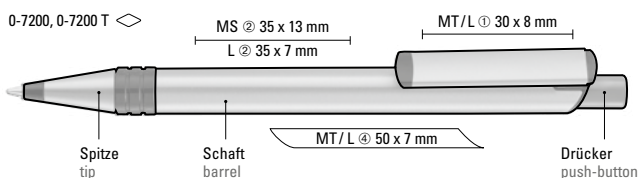

Mindestbestellmenge 300 Stück
Werbeschlüssel Schaft MS/MT/L, Clip MT/L

Minimum quantity 300 pieces
Advertising code barrel MS/MT/L, clip MT/L

RECYCLED PET PEN switch
0-2240

RECYCLED PET PEN switch K transparent
0-2240 KT

Farb-Code/Minen
Colour code/Refills



Das aus recycelten PET-Flaschen in Europa hergestellte rPET-Material eignet sich für einen langlebigen und nachhaltigen Werbeeinsatz. Dank der europäischen und klimaneutralen Produktion leistet der uma RECYCLED PET PEN switch einen zusätzlichen nachhaltigen Beitrag zur Schonung der Umwelt.

Aufgrund der Besonderheiten des Materials (recyceltes PET-Material) sind produktionstechnische Farbschwankungen gegeben.



0-2240 (● 8-0866)

- 57-0298
- 57-0662
- 57-0200
- 57-7492
- 57-0361
- 57-0340
- 57-0002
- 57-7527
- 57-0001
- 57-0012
- 57-0270
- 57-2607
- 57-0233
- 57-0021
- 57-7710
- 57-7500

0-2240 KT (● 8-0866)

- 57-0286
- 57-0185
- 57-0355
- 57-0440
- 57-0291
- 57-0107
- 57-0260
- 57-0226
- 57-0151
- 57-3295



0-2240: Drehkugelschreiber aus recyceltem rPET-Material mit gedeckt glänzendem Gehäuse.

0-2240 KT: Drehkugelschreiber aus recyceltem rPET-Material mit gedeckt glänzendem Gehäuse und transparent glänzendem Clip.

Mindestbestellmenge 1.000 Stück
Werbeschlüssel Schaft S, Clip T

0-2240: Twist ballpoint pen made from recycled PET material with opaque glossy housing.

0-2240 KT: Twist ballpoint pen made from recycled PET material with opaque glossy housing and transparent glossy housing.

Minimum quantity 1,000 pieces
Advertising code barrel S, clip T

0-2240, 0-2240 KT ◊

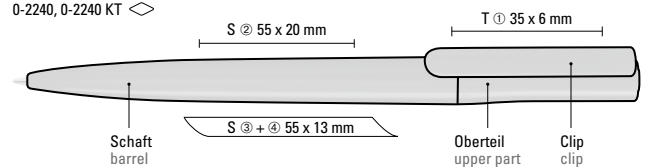

0-2240 T (● 8-0866)

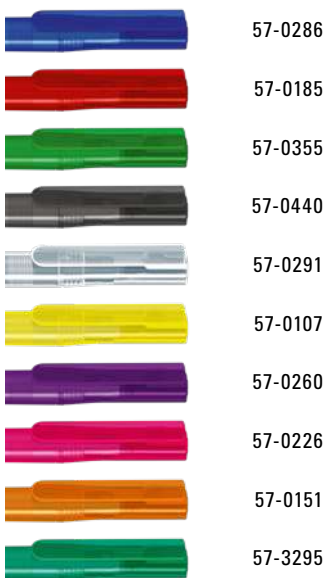

0-2240 T KG (● 8-0866)

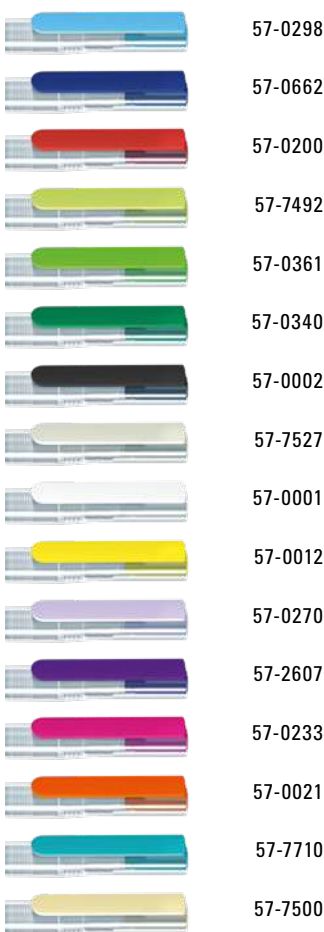

● 8-0866



The rPET material, which is produced in Europe from recycled PET bottles, is suitable for a durable and sustainable advertisement. Thanks to the European and climate-neutral production, the uma RECYCLED PET PEN switch makes an additional sustainable contribution to the protection of the environment.

Due to the special nature of the material (recycled PET material) production-related variations are possible.



0-2240 T, 0-2240 T KG ◊

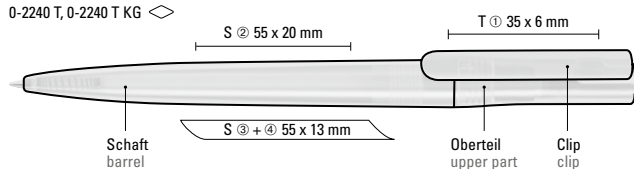

0-2240 T: Drehkugelschreiber aus recyceltem rPET-Material mit transparent glänzendem Gehäuse.

0-2240 T KG: Drehkugelschreiber aus recyceltem rPET-Material mit transparent glänzendem Gehäuse und gedeckt glänzendem Clip.

Mindestbestellmenge 1.000 Stück
Werbeschlüssel Schaft S, Clip T

0-2240 T: Twist ballpoint pen made from recycled PET material with transparent housing.

0-2240 T KG: Twist ballpoint pen made from recycled PET material with transparent housing and opaque glossy clip.

Minimum quantity 1,000 pieces
Advertising code barrel S, clip T



Das aus recycelten PET-Flaschen in Europa hergestellte rPET-Material eignet sich für einen langlebigen und nachhaltigen Werbeeinsatz. Dank der europäischen und klimaneutralen Produktion leistet der uma RECYCLED PET PEN einen zusätzlichen nachhaltigen Beitrag zur Schonung der Umwelt.

Aufgrund der Besonderheiten des Materials (recyceltes PET-Material) sind produktionstechnische Farbschwankungen gegeben.



0-2260 (● 8-0866)
0-2260 T SG (● 8-0866)

- 57-0298
- 57-0662
- 57-0200
- 57-7492
- 57-0361
- 57-0340
- 57-0002
- 57-7527
- 57-0001
- 57-0012
- 57-0270
- 57-2607
- 57-0233
- 57-0021
- 57-7710
- 57-7500

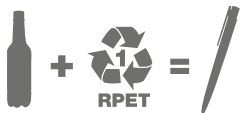

Mix n' Match: Ab 2.000 Stück kann das Modell farblich kombiniert werden.

0-2260: Druckkugelschreiber aus recyceltem rPET-Material mit gedeckt glänzendem Gehäuse und Stopfen.

0-2260 T SG: Druckkugelschreiber aus recyceltem rPET-Material mit klar transparent glänzendem Gehäuse und gedecktem Stopfen.

Mindestbestellmenge 1.000 Stück
Werbeschlüssel Schaft S, Clip T, Stopfen TT

Mix n' Match: From 2,000 pieces, you can choose any colour combination.

0-2260: Retractable ballpoint pen made from recycled PET material with opaque glossy housing and plug.

0-2260 T SG: Retractable ballpoint pen made from recycled PET material with clear transparent housing and opaque glossy plug.

Minimum quantity 1,000 pieces
Advertising code barrel S, clip T, plug TT

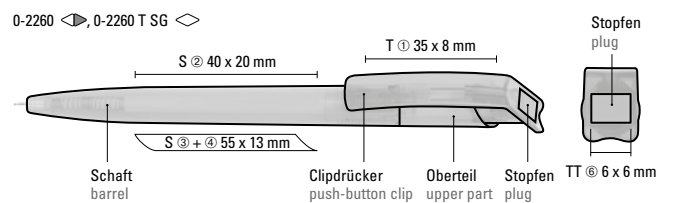

0-2260 T (● 8-0866)



The rPET material, which is produced in Europe from recycled PET bottles, is suitable for a durable and sustainable advertisement. Thanks to the European and climate-neutral production, the uma RECYCLED PET PEN makes an additional sustainable contribution to the protection of the environment.

Due to the special nature of the material (recycled PET material) production-related variations are possible.



0-2260 T ◀

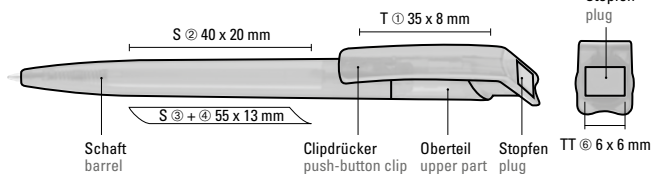

Mix n' Match: Ab 2.000 Stück kann das Modell farblich kombiniert werden.

Mix n' Match: From 2,000 pieces, you can choose any colour combination.

0-2260 T: Druckkugelschreiber aus recyceltem rPET-Material mit transparent glänzendem Gehäuse und gedecktem Stopfen.

0-2260 T: Retractable ballpoint pen made from recycled PET material with transparent housing and opaque glossy plug.

Mindestbestellmenge 1.000 Stück
Werbeschlüssel Schaft S, Clip T, Stopfen TT

Minimum quantity 1,000 pieces
Advertising code barrel S, clip T, plug TT

Antibakterielle Schreibgeräte – sicher und langlebig

Antibacterial writing utensils – save and long-lasting

WARUM GRÜN?



ANTIBAKTERIELL

Hergestellt aus antibakteriellem Kunststoff mit einem speziellen Zusatz, der Silberionen freisetzt, die die Bakterienbildung auf der Stiftoberfläche verhindern.



MADE IN EUROPE

Kurze und schnelle Lieferwege ermöglichen eine zuverlässige und kurzfristige Produktion und schaffen einen zusätzlichen Beitrag zum Erhalt der Umwelt.



KLIMANEUTRAL

Die Schreibgeräte werden in Europa produziert und klimaneutral veredelt. Auf diese Weise wird ein zusätzlich positiver Beitrag für die Umwelt geleistet.



WIRKLICH SICHER

Der verwendete Kunststoff erfüllt europäische und amerikanische FDA-Vorschriften für den Kontakt mit Lebensmitteln.



NATURFREUNDLICH

Die Schreibgeräte wurden aus nicht toxischem Kunststoff, für eine speziell lange Lebensdauer, entwickelt. Das Risiko, dass schädliche Substanzen in die Umwelt abgegeben werden, ist dadurch minimiert.

Eine möglichst lange Verwendung dieses Kugelschreibers hilft uns, die Umweltverschmutzung zu reduzieren und unterstreicht somit die Idee nachhaltiger Werbung.



VORAUSSCHAUEND

Hergestellt aus spielzeuggeeignetem Kunststoff (laut europäischer Norm EN 71, Teil 3 und US FDA-Vorschriften).



GRÜNE CHEMIE

Der Kunststoff enthält keine Dioxine, Phthalate, Bisphenol A, Antimo, Arsen, Barium, Cadmium, Chrom, Quecksilber, Blei, polybromierte Biphenyle (PCB), polybromierte Diphenylether oder Decabromdiphenylether und ist RoHS- und REACH-konform.



CLP-KONFORM

Ungefährlich gemäß der Verordnung zur Einstufung, Kennzeichnung und Verpackung von Stoffen und Gemischen.

WHY GREEN?



ANTIBACTERIAL

It is made of antibacterial plastic containing a special additive which releases silver ions that prevent bacteria from colonising the surface of the pen.



MADE IN EUROPE

Short and fast delivery routes enable reliable and short-term production and create an additional contribution to the preservation to the environment.



CLIMATE-NEUTRAL

The writing instruments are produced in Europe and finished climate-neutral in the Black Forest. In this way, an additional positive contribution to the environment is made.



REALLY SAFE

The plastics employed are compliant with European and American FDA food contact regulations.



NATURE FRIENDLY

Made of non-toxic plastics, it has been designed to have a long life and to minimise the risk of harmful substances being released into the environment. Using a pen for as long as possible helps to reduce pollution and enables us to give full expression to the concept of promotion.



LOOKING TO THE FUTURE

Made of plastic suitable for toy manufacture (according to European standard EN 71-03 and U.S. FDA regulations).



GREEN CHEMICAL

It does not contain dioxin, phthalates, bisphenol A, antimony, arsenic, barium, cadmium, chrome, mercury, lead, polybrominated biphenyls (PBBs), polybrominated diphenyl ethers (PBDEs) or deca-BDE, and conforms to RoHS and REACH directives.



CLP COMPLIANT

It is rated as non hazardous pursuant to the Regulation on Classification, Labelling and Packaging.



0-0086 GREEN (● 8-0866)

0-0056 GREEN (● 8-0866)

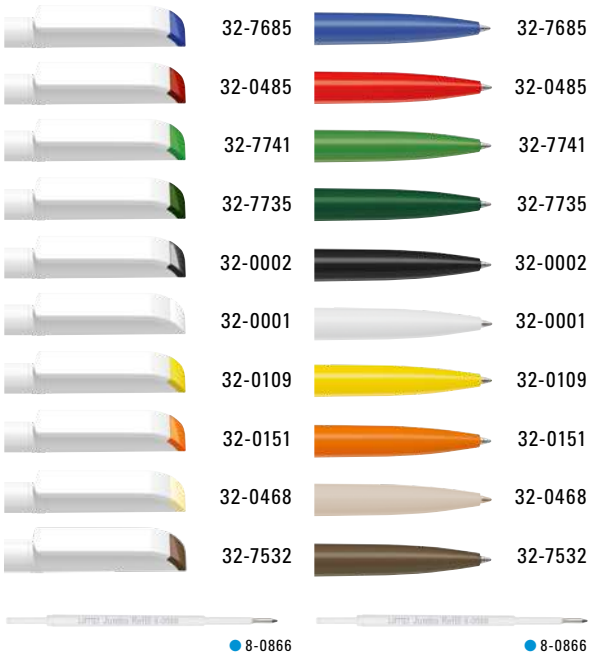

Der nach ISO 22196:2011 geprüfte antimikrobielle Zusatz aus Silberionen verleiht dem Kunststoff eine antibakterielle Wirkung, die eine Haftung und Ansiedlung von Bakterien oder Krankheitserregern auf der Oberfläche des Schreibgerätes um 99,99% verringert. Der verarbeitete Kunststoff ist nicht nur antibakteriell, sondern auch schadstofffrei und umweltverträglich und entspricht den europäischen Lebensmittelrichtlinien, sowie der amerikanischen FDA.

The antimicrobial additive of silver ions, tested according to ISO 22196:2011, gives the plastic an antibacterial effect that reduces the adhesion and settling of bacteria or pathogens on the surface of the writing instruments by 99.99%. The processed plastic is not only antibacterial, but also pollutant-free and environmentally friendly and complies with European food as well as American FDA guidelines.



Hinweis im Schaft eingelassen:
„antibacterial/green chemical“
Note embedded into the barrel
„antibacterial/green chemical“

Aufgrund der Besonderheiten des Materials (recyceltes PET-Material) sind produktionstechnische Farbschwankungen gegeben.
Due to the special nature of the material (recycled PET material) production-related variations are possible.

LOVING NATURE
—
Antibacterial,
non-toxic and sustainable.
A pen that lasts
is a pen that nature
loves.

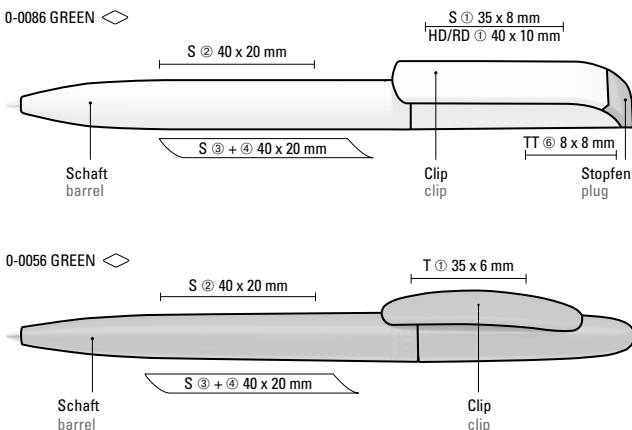

0-0086 GREEN: Drehkugelschreiber mit antibakteriell wirkendem Kunststoffgehäuse in gedeckt glänzend weiß mit farbigem Stopfen.

0-0056 GREEN: Drehkugelschreiber mit antibakteriell wirkendem Kunststoffgehäuse in gedeckt glänzend.

0-0086 GREEN
Mindestbestellmenge 1.000 Stück
Werbeschlüssel Schaft S, Clip S/HD/RD, Stopfen TT

0-0056 GREEN
Mindestbestellmenge 1.000 Stück
Werbeschlüssel Schaft S, Clip T

0-0086 GREEN: Twist ballpoint pen with antibacterial plastic housing in opaque glossy white with coloured plug.

0-0056 GREEN: Twist ballpoint pen with antibacterial plastic housing and opaque glossy finish.

0-0086 GREEN
Minimum quantity 1,000 pieces
Advertising code barrel S, clip S/HD/RD, plug TT

0-0056 GREEN
Minimum quantity 1,000 pieces
Advertising code barrel S, clip T



Aufgrund der Besonderheiten des Materials (recycliertes PET-Material) sind produktionstechnische Farbschwankungen gegeben.

Due to the special nature of the material (recycled PET material) production-related variations are possible.



Hinweis im Schaft aufgedruckt:
„antibacterial“
Note printed on the barrel
„antibacterial“



Der nach ISO 22196:2011 geprüfte antimikrobielle Zusatz aus Silberionen verleiht dem Kunststoff eine antibakterielle Wirkung, die eine Haftung und Ansiedlung von Bakterien oder Krankheitserregern auf der Oberfläche des Schreibgerätes um 99,99% verringert. Der verarbeitete Kunststoff ist nicht nur antibakteriell, sondern auch schadstofffrei und umweltverträglich und entspricht den europäischen Lebensmittelrichtlinien, sowie der amerikanischen FDA.

The antimicrobial additive of silver ions, tested according to ISO 22196:2011, gives the plastic an antibacterial effect that reduces the adhesion and settling of bacteria or pathogens on the surface of the writing instruments by 99.99%. The processed plastic is not only antibacterial, but also pollutant-free and environmentally friendly and complies with European food as well as American FDA guidelines.



0-0017 F GREEN: Druckkugelschreiber mit antibakteriell wirkendem Kunststoffgehäuse in weiß matt, Bogenclip und Drücker.

Mindestbestellmenge 1.000 Stück
Werbeschlüssel Schaft S ○, Clip T

0-0017 F GREEN: Retractable ballpoint pen with antibacterial plastic housing in white matt, curved clip and push-button.

Minimum quantity 1,000 pieces
Advertising code barrel S ○, clip T

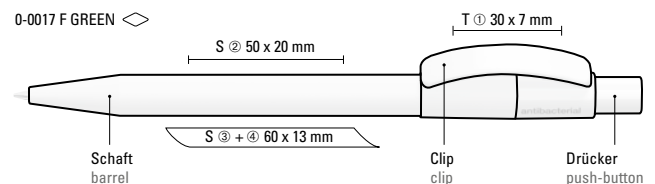

0-0093 ANTIBAC (● 8-0854)

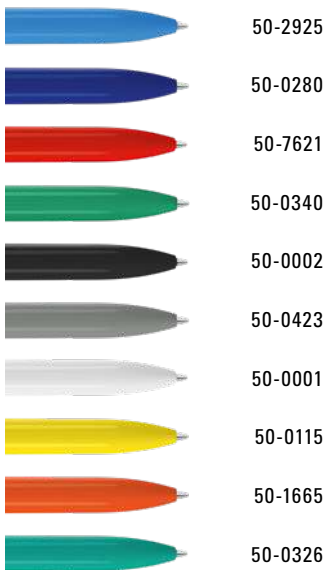

0-0092 RECY (● 8-0854)

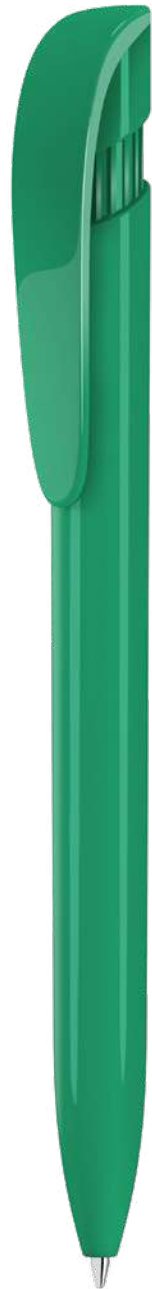
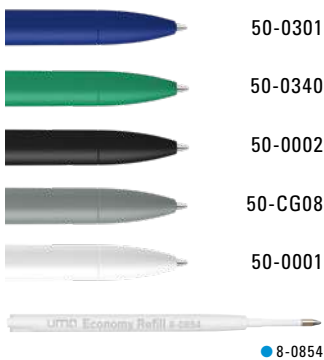

Hinweis im Schaft aufgedruckt:
„antibacterial“
Note printed on the barrel
„antibacterial“



Das Gehäuse des YES RECY wird aus Spritzgussresten der eigenen Spritzgussgießerei hergestellt und ist mit dem rABS Logo gekennzeichnet.

The housing of the YES RECY is obtained from the injection moulding debris from our own injection moulding plant and is marked with the rABS logo.

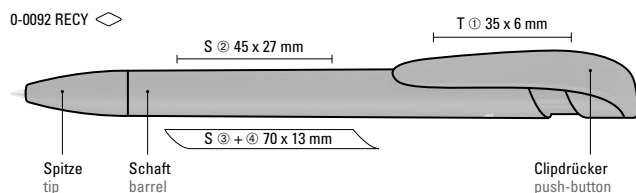
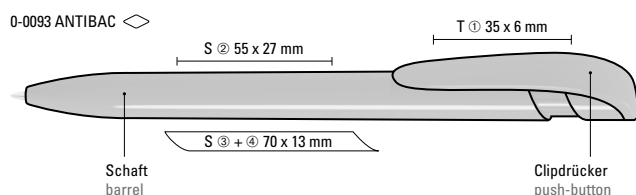

0-0093 ANTIBAC: Druckkugelschreiber mit gedeckt glänzendem, antibakteriellen Gehäuse und breitem Bogenclipdrücker. Der nach ISO 22196:2011 geprüfte antimikrobielle Zusatz aus Silberionen verleiht dem Kunststoff eine antibakterielle Wirkung, die eine Haftung und Ansiedlung von Bakterien oder Krankheitserregern auf der Oberfläche des Schreibgerätes um 99,99% verringert.

0-0092 RECY: Druckkugelschreiber mit gedeckt mattem Gehäuse, breitem Bogenclipdrücker und Spitze aus recyceltem Kunststoff. Das Modell ist mit dem Recyclingzeichen gekennzeichnet. Aufgrund der Besonderheit des Materials (ABS Recycled Plastic) sind produktionstechnische Farbschwankungen gegeben.

0-0093 ANTIBAC: Retractable ballpoint pen with opaque glossy antibacterial housing and wide curved clip button. The antimicrobial additive of silver ions, tested according to ISO 22196:2011, gives the plastic an antibacterial effect that reduces the adhesion and settling of bacteria or pathogens on the surface of the writing instrument by 99.99%.

0-0092 RECY: Retractable ballpoint pen with opaque matt housing, wide curved clip button and tip made from recycled plastic. The model is labelled with the recycling mark. Due to the special nature of the material (ABS recycled plastic) colour variations may occur during the production process.

Mindestbestellmenge 1.000 Stück
Werbeschlüssel Schaft S ◊, Clip T

Minimum quantity 1,000 pieces
Advertising code barrel S ◊, clip T



1-0736 RECY (● 8-0877)



Das Gehäuse des VITAN RECY wird aus Spritzgussresten der eigenen Spritzgussgießerei hergestellt und ist mit dem rABS Logo gekennzeichnet.

The housing of the VITAN RECY is obtained from the injection moulding debris from our own injection moulding plant and is marked with the rABS logo.



Das Modell VITAN finden Sie auf Seite 203.

The model VITAN can be found on page 203.

1-0736 RECY: Druckkugelschreiber mit gedeckt glänzendem Gehäuse aus 100% recyceltem Kunststoff und großem Clip an verstärkter Clipanbindung. Aufgrund der Besonderheit des Materials (ABS Recycled Plastic) sind produktionstechnische Farbschwankungen gegeben.

1-0736 RECY: Retractable ballpoint pen with opaque glossy body and large clip made from 100% recycled plastic. Due to the special nature of the material (ABS recycled plastic) colour variations may occur during the production process.

Mindestbestellmenge 1.000 Stück
Werbeschlüssel Schaft S ○, Clip T

Minimum quantity 1,000 pieces
Advertising code barrel S ○, clip T

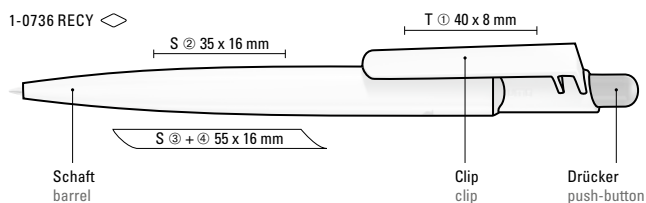

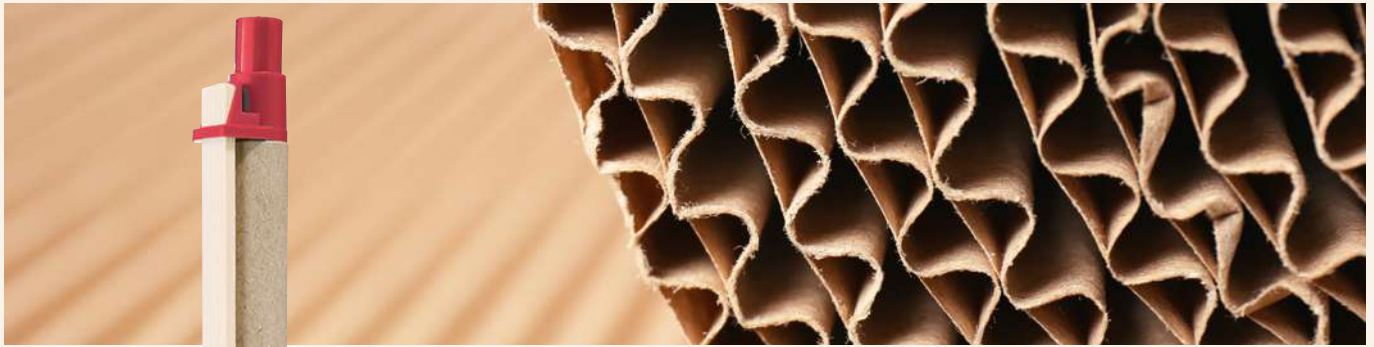

Recycelter Karton

Die Verwendung von bereits **recycelter Kartonage** bietet eine stabile und zugleich umweltverträgliche Grundlage für die Herstellung von Schreibgeräten. Das Material kann dem Recyclingprozess wieder zugeführt werden und trägt so zur Umweltschonung bei. Die Verwendung dieser besonderen Materialien sind produktionstechnischen Schwankungen unterlegen. Leichte Unterschiede in Farbe und Oberfläche sind daher möglich.

Das Gehäuse des PAPER PENs wird aus recycelter Kartonage hergestellt.

The housing of the PAPER PEN is made of recycled cardboard.

PAPER PEN
6-2250 H

Recycled cardboard

The use of **cardboard** that has already been **recycled** offers a stable and at the same time environmentally friendly basis for the production of writing utensils. The material can be returned to the recycling process again, thus contributing to helping the environment. The use of these special materials is subject to fluctuations in the production technology. As a result, slight differences in colour and surface are possible.



Cellulose

Der aus der Natur gewonnene Rohstoff kann dieser ebenfalls wieder zugeführt werden. Das **Celluloseacetat** entspricht der DIN EN 13432:2000-12/Zertifizierungsprogramm für Produkte aus kompostierbaren Werkstoffen. Die hierfür notwendige Cellulose wird aus europäischen Weichhölzern gewonnen.

Cellulose acetate

The raw material gained from nature can also be returned to nature. The **cellulose acetate** complies with DIN EN 13432:2000-12/certification program for products from compostable materials. The cellulose required for this is gained from European softwoods.

Das Gehäuse des BIO-PENs wird aus Celluloseacetat gefertigt und ist mit dem BIO-PEN-Logo gekennzeichnet.

The housing of the BIO-PEN is made of cellulose acetate and is marked with the BIO-PEN logo.

BIO PEN
6-3550



rABS – recyclerter Kunststoff

Recyclerter ABS-Kunststoff wird aus den **Spritzgussresten** der eigenen Spritzgießerei gewonnen. Hierzu werden die Kunststoffabfälle gesammelt und dem Spritzgussprozess wieder zugeführt. Die gesammelten Kunststoffe können sortenrein und qualitätsbestimmt gesammelt werden. Durch das Aufbereiten der Kunststoffe kann aus diesen ein recyceltes Produkt gefertigt werden. Generell wird durch das Recyceln der Kunststoffe weniger Rohöl und Energie verbraucht.

rABS – recycled plastic

Recycled ABS plastic is obtained from the **injection moulding** debris from our own injection moulding plant. For this, plastic waste is collected up and directed back into the injection moulding process. The collected plastics can be collected, graded and grouped by quality standard. These preparatory operations with plastics are the key to manufacturing a recycled product. Without exception, the recycling of plastics uses less crude oil and power.

Das Gehäuse des HAPPY RECY wird aus recyceltem ABS Kunststoff hergestellt und ist mit dem rABS Logo gekennzeichnet.

The housing of the HAPPY RECY is made of recycled plastics (ABS) and is marked with the rABS logo.

HAPPY RECY
0-0037 RECY



rPCP – recyclerter Post-Consumer-Kunststoff

Recyclerter Post-Consumer-Kunststoff (ABS) wird meist aus technischen (Haushalts-) Geräten oder sonstigen **Consumer Kunststoffabfällen** gewonnen. Hierzu werden die Kunststoffe gesammelt und sortenrein recycelt. Die sogenannten Post Consumer oder Post Industry Kunststoffe können nach der Aufbereitung in ein neues Produkt upgecycelt werden. Generell wird durch das Recyceln der Kunststoffe weniger Rohöl und Energie verbraucht.

rPCP – recycled post-consumer plastic

For the most part, recycled post-consumer plastic (ABS) is obtained from technical (domestic) appliances or other forms of **plastic consumer waste**. This process involves collecting and grading plastics and recycling each grade separately. After the recycling process, a new product can be 'upcycled' from what are known as post-consumer or also post industry plastics. Without exception, the recycling of plastics uses less crude oil and power.

Das Gehäuse des ICONIC RECY wird aus recyceltem Post-Consumer-Kunststoff (ABS) hergestellt und ist mit dem POST-CONSUMER-RECYCLED-PLASTIC-Logo gekennzeichnet.

The housing of the ICONIC RECY is made of recycled Post-Consumer plastics (ABS) and is marked with the POST-CONSUMER RECYCLED PLASTIC logo.

ICONIC RECY
0-0057 RECY



0-0037 RECY (● 8-0865)



Das Gehäuse des HAPPY RECY wird aus Spritzgussresten der eigenen Spritzgussgießerei hergestellt und ist mit dem rABS Logo gekennzeichnet.

The housing of the HAPPY RECY is obtained from the injection moulding debris from our own injection moulding plant and is marked with the rABS logo.



Die Modelle von HAPPY, HAPPY frozen und HAPPY GUM finden Sie ab Seite 110.

The models HAPPY, HAPPY frozen und HAPPY GUM can be found from page 110.

0-0037 RECY: Druckkugelschreiber mit gedeckt mattem Gehäuse und Clipdrücker aus recyceltem Kunststoff. Aufgrund der Besonderheit des Materials (ABS Recycled Plastic) sind produktionstechnische Farbschwankungen gegeben.

0-0037 RECY: Retractable ballpoint pen with opaque matt housing and clip button made of recycled plastic. Due to the special nature of the material (ABS recycled plastic) colour variations may occur during the production process.

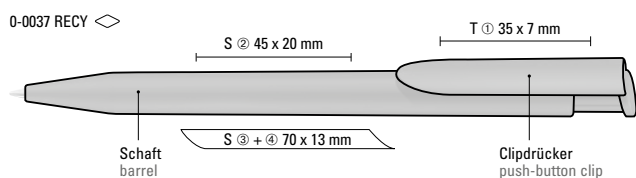

Mindestbestellmenge 1.000 Stück
Werbeschlüssel Schaft S ○, Clip T

Minimum quantity 1,000 pieces
Advertising code barrel S ○, clip T



0-0057 RECY (● 8-0866)



Das Modell ist mit dem Recyclingzeichen gekennzeichnet.
Aufgrund der Besonderheit des Materials (Post-Consumer Recycled Plastic) sind produktionstechnische Farbschwankungen gegeben.

The model is labelled with the recycling mark. Due to the special nature of the material (post-consumer recycled plastic) colour variations may occur during the production process.

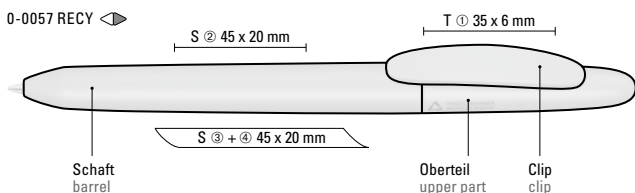

Mix n' Match: Ab 2.000 Stück kann das Modell farblich kombiniert werden.

0-0057 RECY: Drehkugelschreiber mit gedeckt mattem Gehäuse aus 100% recyceltem Post-Consumer-Kunststoff.

Mindestbestellmenge 1.000 Stück
Werbeschlüssel Schaft S, Clip T

Mix n' Match: From 2,000 pieces, you can choose any colour combination.

0-0057 RECY: Twist ballpoint pen with opaque matt housing made from 100% recycled post-consumer plastic.

Minimum quantity 1,000 pieces
Advertising code barrel S, clip T



0-0183 RECY (● 8-0866)



Das Modell ist mit dem Recyclingzeichen gekennzeichnet. Aufgrund der Besonderheit des Materials (Post-Consumer Recycled Plastic) sind produktionstechnische Farbschwankungen gegeben.

The model is labelled with the recycling mark. Due to the special nature of the material (post-consumer recycled plastic) colour variations may occur during the production process.



Mix n' Match: Ab 2.000 Stück kann das Modell farblich kombiniert werden.

Mix n' Match: From 2,000 pieces, you can choose any colour combination.

0-0183 RECY: Drehkugelschreiber mit gedeckt mattem Gehäuse und Clip aus 100% recyceltem Post-Consumer-Kunststoff.

0-0183 RECY: Twist ballpoint pen with opaque matt housing and clip made from 100% recycled post-consumer plastic.

Mindestbestellmenge 1.000 Stück
Werbeschlüssel Schaft S, Clip T/HD/RD

Minimum quantity 1,000 pieces
Advertising code barrel S, clip T/HD/RD

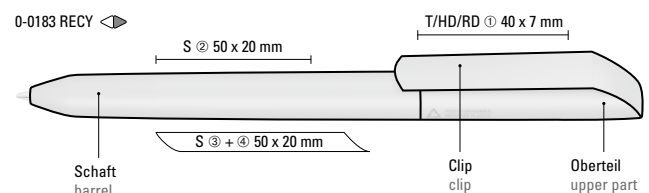

0-0071 RECY (● 8-0866)



Das Modell ist mit dem Recyclingzeichen gekennzeichnet. Aufgrund der Besonderheit des Materials (Post-Consumer Recycled Plastic) sind produktionstechnische Farbschwankungen gegeben.

The model is labelled with the recycling mark. Due to the special nature of the material (post-consumer recycled plastic) colour variations may occur during the production process.

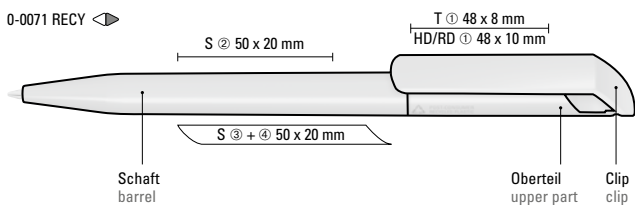

Mix n' Match: Ab 2.000 Stück kann das Modell farblich kombiniert werden.

Mix n' Match: From 2,000 pieces, you can choose any colour combination.

0-0071 RECY: Drehkugelschreiber mit gedeckt glänzendem Gehäuse aus 100% recyceltem Post-Consumer-Kunststoff.

0-0071 RECY: Twist ballpoint pen with opaque glossy housing made from 100% recycled post-consumer plastic.

Mindestbestellmenge 1.000 Stück
Werbeschlüssel Schaft S, Clip T/HD/RD

Minimum quantity 1,000 pieces
Advertising code barrel S, clip T/HD/RD



Das Modell ist mit dem Recyclingzeichen gekennzeichnet.
Aufgrund der Besonderheit des Materials (Post-Consumer Recycled Plastic) sind produktionstechnische Farbschwankungen gegeben.

The model is labelled with the recycling mark. Due to the special nature of the material (post-consumer recycled plastic) colour variations may occur during the production process.

0-0063 RECY (● 8-0866)

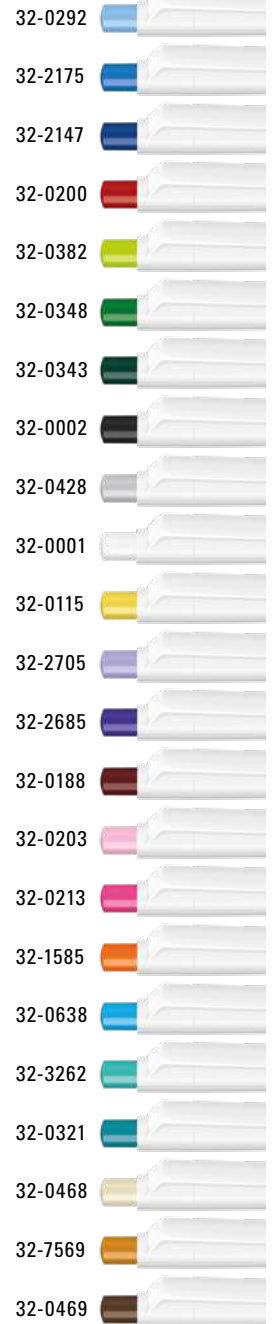
Drücker/Stopfen ABS
push-button/plug ABS

0-0063 RECY:
Drücker und Stopfen sind ab
2.000 Stück auch in allen glänzend
gedeckten ABS Standardfarben
erhältlich.

0-0063 RECY:
From 2,000 units, push-buttons
and plugs are available in all solid
shiny ABS standard colours.



Mix n' Match: Ab 2.000 Stück kann das Modell farblich kombiniert werden.

0-0063 RECY: Druckkugelschreiber mit gedeckt mattem Gehäuse, Clip, Drücker und Stopfen aus 100% recyceltem Post-Consumer-Kunststoff.





Mindestbestellmenge 1.000 Stück
Werbeschlüssel Schaft S, Clip T/HD/RD

Mix n' Match: From 2,000 pieces, you can choose any colour combination.

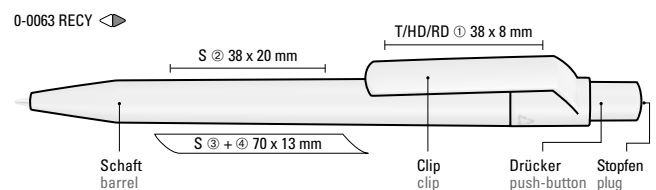
0-0063 RECY: Retractable ballpoint pen with opaque matt housing, clip, push-button and plug made of 100% recycled post-consumer plastic.

Minimum quantity 1,000 pieces
Advertising code barrel S, clip T/HD/RD



0-0017 RECY (● 8-0866)		Drücker ABS push-button ABS
	32-0534	 32-2175
	32-0350	 32-2147
	32-0432	 32-0200
	32-0425	 32-0348
	32-0428	 32-0343
	32-0001	 32-0002
	32-0466	 32-0001
	32-7532	 32-0468
	● 8-0866	 32-0115
		 32-1585
		 32-0188



0-0017 RECY:
Drücker sind ab 2.000 Stück auch in allen glänzend gedeckten ABS Standardfarben erhältlich.

0-0017 RECY:
From 2,000 units, plugs are available in all solid shiny ABS standard colours.



Das Modell ist mit dem Recyclingzeichen gekennzeichnet.
Aufgrund der Besonderheit des Materials (Post-Consumer Recycled Plastic) sind produktionstechnische Farbschwankungen gegeben.

The model is labelled with the recycling mark. Due to the special nature of the material (post-consumer recycled plastic) colour variations may occur during the production process.

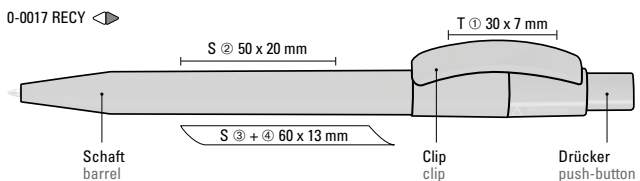

Mix n' Match: Ab 2.000 Stück kann das Modell farblich kombiniert werden.

0-0017 RECY: Druckkugelschreiber mit gedeckt mattem Kunststoffgehäuse aus 100% recyceltem Post-Consumer-Kunststoff, glänzendem Bogenclip und Drücker.

Mindestbestellmenge 1.000 Stück
Werbeschlüssel Schaft S ○, Clip T

Mix n' Match: From 2,000 pieces, you can choose any colour combination.

0-0017 RECY: Retractable ballpoint pen with matt plastic housing made from 100% recycled post-consumer plastic, opaque glossy curved clip and push-button.

Minimum quantity 1,000 pieces
Advertising code barrel S ○, clip T

CETA RECY
1-0041 RECY

CHILL C SI RECY
1-0043 C-SI RECY

Farb-Code/Minen
Colour code/Refills



1-0041 RECY (●●● 8-0855)
1-0043 C-SI RECY (●●● 8-0855)

01-0002 

01-0427 

●●● 8-0855

Die Modelle sind mit dem Recyclingzeichen gekennzeichnet. Aufgrund der Besonderheit des Materials (Post-Consumer Recycled Plastic) sind produktionstechnische Farbschwankungen gegeben.

The models are labelled with the recycling mark. Due to the special nature of the material (post-consumer recycled plastic) colour variations may occur during the production process.



1-0041 RECY: Drehkugelschreiber mit gedeckt mattem Gehäuse aus 100% recyceltem Post-Consumer-Kunststoff.

1-0043 C-SI RECY: Drehkugelschreiber mit gedeckt glänzendem Gehäuse aus 100% recyceltem Post-Consumer-Kunststoff. Metallclip und schwere Metallspitze matt verchromt.

1-0041 RECY
Mindestbestellmenge 1.000 Stück
Werbeschlüssel Schaft S ○, Clip T

1-0043 C-SI RECY
Mindestbestellmenge 1.000 Stück
Werbeschlüssel Schaft S ○, Clip MT/L, Oberteil T

1-0041 RECY: Twist ballpoint pen with opaque matt housing made from 100% recycled post-consumer plastic.

1-0043 C-SI RECY: Twist ballpoint pen with opaque glossy housing made from 100% recycled post-consumer plastic. Metal clip and heavy metal tip matt chromed.

1-0041 RECY
Minimum quantity 1,000 pieces
Advertising code barrel S ○, clip T

1-0043 C-SI RECY
Minimum quantity 1,000 pieces
Advertising code barrel S ○, clip MT/L, upper part T

umaBlackForest
Pens

Klimaneutral
Schreibgerät
ClimatePartner.com/13223-2104-1001

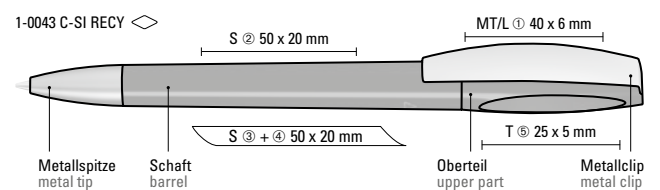
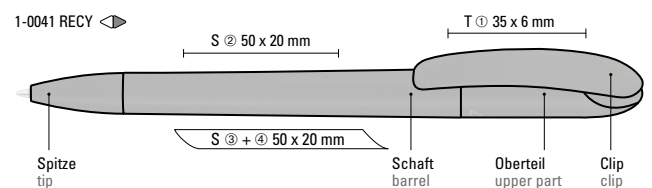

1-0048 SI RECY (● 8-0855)



01-0002



01-0427



● 8-0855

1-0048 SI,
1-0048 TF-SI,
1-0048 SI RECY
Stopfen ABS
plug ABS

-  01-0004
-  01-0284
-  01-0286
-  01-0280
-  01-0200
-  01-0375
-  01-0340
-  01-0002
-  01-0430
-  01-0001
-  01-0108
-  01-0137
-  01-0526
-  01-0219
-  01-0172
-  01-3262



Das Modell ist mit dem Recyclingzeichen gekennzeichnet. Aufgrund der Besonderheit des Materials (Post-Consumer Recycled Plastic) sind produktionstechnische Farbschwankungen gegeben.

The model is labelled with the recycling mark. Due to the special nature of the material (post-consumer recycled plastic) colour variations may occur during the production process.



umaBlackForest
Pens

Klimaneutral
Schreibgerät
ClimatePartner.com/13223-2104-1001

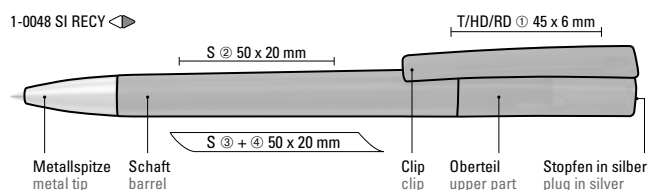

1-0048 SI RECY: Drehkugelschreiber mit gedeckt mattem Gehäuse aus 100% recyceltem Post-Consumer-Kunststoff. Metallspitze matt verchromt. Stopfen optional in verschiedenen matt gedeckten Farben oder silber (Standard ABS) erhältlich.

Mindestbestellmenge
Werbeschlüssel

1.000 Stück
Schaft S ○,
Clip T/HD/RD

1-0048 SI RECY: Twist ballpoint pen with opaque matt housing made from 100% recycled post-consumer plastic. Metal tip matt chromed. Plugs optionally available in various matt colours or silver (standard ABS).

Minimum quantity
Advertising code

1,000 pieces
barrel S ○,
clip T/HD/RD



Farb-Code/Minen
Colour code/Refills

TREE
5-5400 **new!**

LEAF
5-5900

5-5400 (● 8-0877)



5-5900 (● 8-0855)



Das Zeichen für verantwortungsvolle Waldwirtschaft

Für dieses uma Schreibgerät aus Holz wird FSC®-zertifiziertes Buchenholz verwendet. Durch spezielle Bearbeitung des nachwachsenden Rohstoffs transportiert das Naturprodukt Ihre Werbebotschaft edel und formschön zum Kunden.

Der Naturstoff Holz variiert sowohl in der Farbigkeit des Holzes, als auch in der Struktur (Maserung).

Only FSC® certified beechwood is used for this uma writing utensil made of wood. Through special processing of the sustainable raw material, the natural product transports its advertising message in a refined and beautiful design to the customer.

Wood is a natural material with a great variety of colours and textures (grain effect).

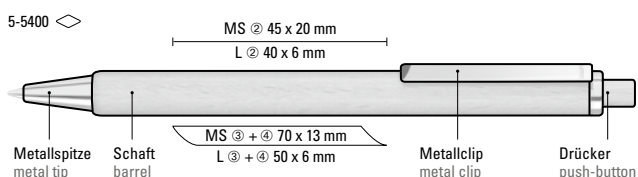

5-5400 : Holz-Druckkugelschreiber mit Holzdrücker, Metallclip und Metallspitze glanzverchromt. Schaft und Drücker aus schutzlackiertem PEFC-zertifiziertem Buchenholz.

5-5400: Wooden retractable ballpoint pen with wooden push-button, metal clip and metal tip chrome plated. Barrel and push-button made from PEFC-certified beechwood with protective varnish coating.

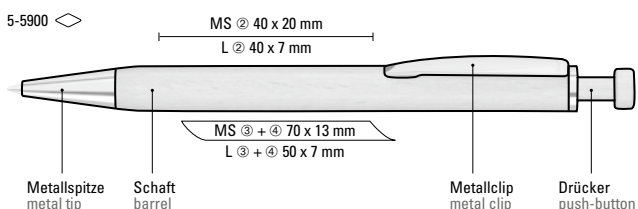

5-5900: Holz-Druckkugelschreiber mit Holzdrücker, Metallclip und Metallspitze glanzverchromt. Schaft und Drücker aus schutzlackiertem FSC®-zertifiziertem Buchenholz.

5-5900: Wooden retractable ballpoint pen with wooden push-button, metal clip and metal tip chrome plated. Barrel and push-button in FSC® certified beechwood with protective varnish coating.

Mindestbestellmenge
Werbeschlüssel

300 Stück
Schaft MS/L

Minimum quantity
Advertising code

300 pieces
barrel MS/L

WOODY
5-5600

WOODY B
5-5607 B

CALIBRA S
5-5100

Farb-Code/Minen
Colour code/Refills



5-5600 (● 8-0855)
5-5607 B (0,7mm)

05-W001



● 8-0855

5-5100 (● 8-0888)

05-W001



● 8-0888



Für diese uma Schreibgeräte aus Holz wird ausschließlich deutsches, PEFC-zertifiziertes Buchenholz verwendet. Durch spezielle Bearbeitung des nachwachsenden Rohstoffs transportiert das Naturprodukt Ihre Werbebotschaft edel und formschön zum Kunden.

Der Naturstoff Holz variiert sowohl in der Farbigkeit des Holzes, als auch in der Struktur (Maserung).

5-5600: Holz-Druckkugelschreiber mit Holz-Kugeldrucker, Metallclip und Metallspitze silber glänzend. Schaft und Drucker aus schutzlackiertem PEFC-zertifiziertem Buchenholz.

5-5607 B: Holz-Druckbleistift (0,7mm) mit Holz-Kugeldrucker, Metallclip und Metallspitze silber glänzend. Schaft und Drucker aus schutzlackiertem PEFC-zertifiziertem Buchenholz.

5-5100: Holz-Druckkugelschreiber mit Metalldrucker, Metallclip und Metallspitze silber glänzend. Schaft aus schutzlackiertem PEFC-zertifiziertem Buchenholz.

Mindestbestellmenge 300 Stück
Werbeschlüssel Schaft MS/L

5-5600: Wooden retractable ballpoint pen with wooden ball-button, metal clip and metal tip silver glossy. Barrel and push-button made from PEFC certified beechwood with protective varnish coating.

5-5607 B: Wooden mechanical pencil (0.7mm) with wooden ball-button, metal clip and metal tip silver glossy. Barrel and push-button made from PEFC certified beechwood with protective varnish coating.

5-5100: Wooden retractable ballpoint pen with metal push-button, metal clip and metal tip silver glossy. Barrel made from PEFC certified beechwood with protective varnish coating.

Minimum quantity 300 pieces
Advertising code barrel MS/L

Klimaneutral
Schreibgerät
ClimatePartner.com/13223-1907-1003

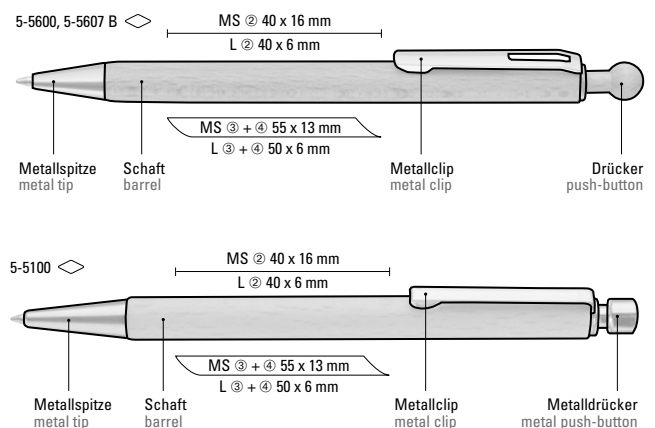

Farb-Code/Minen
Colour code/Refills

FOREST
5-5200

FOREST B
5-5207 B

BEECH
5-5800

5-5200 (● 8-0877)
5-5207 B (0,7mm)



05-W001



● 8-0877

5-5800 (● 8-0855)



08-W001



● 8-0855



PEFC
PEFC/04-31-3311

Only PEFC-certified german beechwood is used for these writing utensils made of wood. Through special processing of the sustainable raw material, the natural product transports its advertising message in a refined and beautiful design to the customer.

Wood is a natural material with a great variety of colours and textures (grain effect).



5-5200: Holz-Druckkugelschreiber mit Holzdrücker, Metallclip und Metallspitze silber glänzend. Schaft und Drücker aus schutzlackiertem PEFC-zertifiziertem Buchenholz.

5-5200: Wooden retractable ballpoint pen with wooden push-button, metal clip and metal tip silver glossy. Barrel and push-button made from PEFC certified beechwood with protective varnish coating.

5-5207 B: Holz-Druckbleistift (0,7mm) mit Holzdrücker, Metallclip und Metallspitze silber glänzend. Schaft und Drücker aus schutzlackiertem PEFC-zertifiziertem Buchenholz.

5-5207 B: Wooden mechanical pencil (0.7mm) with wooden push-button, metal clip and metal tip silver glossy. Barrel and push-button made from PEFC certified beechwood with protective varnish coating.

5-5800: Holz-Druckkugelschreiber mit Holzdrücker, Metallclip und Metallspitze glanzverchromt. Schaft und Drücker aus schutzlackiertem PEFC-zertifiziertem Buchenholz.

5-5800: Wooden retractable ballpoint pen with wooden push-button, metal clip and metal tip chrome plated. Barrel and push-button made from PEFC certified beechwood with protective varnish coating.

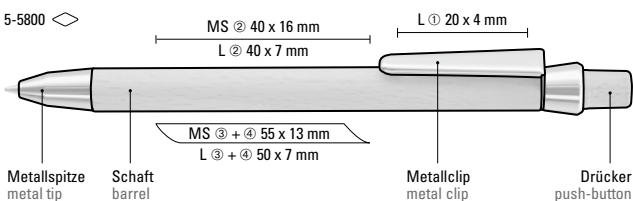
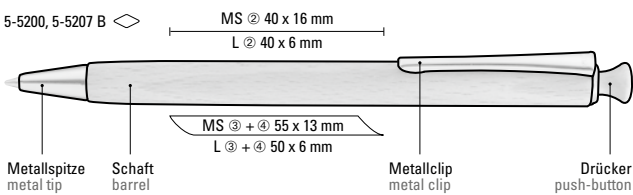

5-5200, 5-5207 B
Mindestbestellmenge 300 Stück
Werbeschlüssel Schaft MS/L

5-5800
Mindestbestellmenge 300 Stück
Werbeschlüssel Schaft MS/L, Clip L

5-5200, 5-5207 B
Minimum quantity 300 pieces
Advertising code barrel MS/L

5-5800
Minimum quantity 300 pieces
Advertising code barrel MS/L, clip L



0-9370 (● 8-0888)
0-9372 R (● 8-0806)

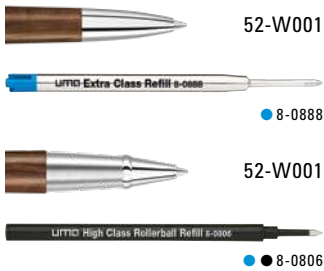

Das Zeichen für verantwortungsvolle Waldwirtschaft



Der Naturstoff Holz variiert sowohl in der Farbigkeit des Holzes, als auch in der Struktur (Maserung).

Wood is a natural material with a great variety of colours and textures (grain effect).



Etui Empfehlung/Case suggestion

ETUI 0-0944
Zweiteiliges Pappetui mit abnehmbarem Deckel und W-Einlage – siehe Seite 299.

Two-piece cardboard case with removable lid and W-inlay – see on page 299.

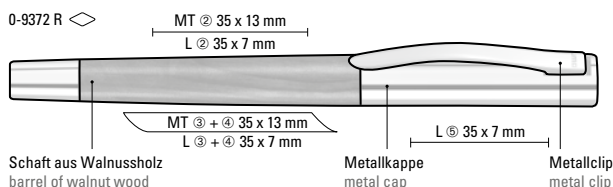
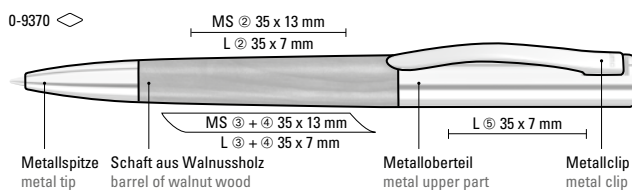

0-9370: Metall-Drehkugelschreiber mit Schaft aus FSC®-zertifiziertem Walnussholz, Softdrehmechanik und gefedertem Clip. Oberteil, Clip und Spitze glanzverchromt.

0-9372 R: Metall-Rollerball mit Schaft aus FSC®-zertifiziertem Walnussholz und gefedertem Clip. Kappe und Clip glanzverchromt.

0-9370
Mindestbestellmenge 100 Stück
Werbeschlüssel Schaft MS/L, Oberteil L

0-9372 R
Mindestbestellmenge 100 Stück
Werbeschlüssel Schaft MT/L, Kappe L

0-9370: Metal twist ballpoint pen with barrel made from FSC® certified walnut wood, soft twist mechanism and spring-mounted clip. Upper part, clip and tip glossy chrome plated.

0-9372 R: Metal roller ball with barrel made from FSC® certified walnut wood, spring-mounted clip. Cap and clip glossy chrome plated.

0-9370
Minimum quantity 100 pieces
Advertising code barrel MS/L, upper part L

0-9372 R
Minimum quantity 100 pieces
Advertising code barrel MT/L, cap L



0-9190 WOOD (● 8-0888)



53-W001



● 8-0888



Das Zeichen für verantwortungsvolle Waldwirtschaft



Der Naturstoff Holz variiert sowohl in der Farbigkeit des Holzes, als auch in der Struktur (Maserung).

Wood is a natural material with a great variety of colours and textures (grain effect).

0-9190 WOOD ◊

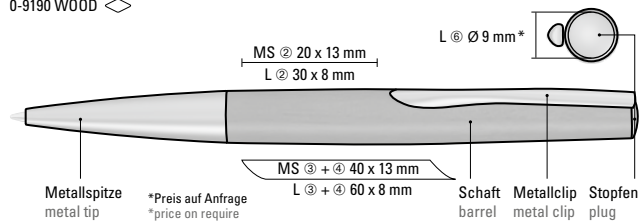

0-9190 WOOD:
Metall-Drehkugelschreiber mit Schaft aus FSC®-zertifiziertem Walnussholz, gefederter Metallclip, Metallstopfen, schwere Metallspitze matt verchromt und Softdrehmechanik.

0-9190 WOOD:
Metal twist ballpoint pen with FSC® certified walnut barrel, spring-mounted metal clip, plug, metal tip matt chrome plated and soft twist mechanism.

Mindestbestellmenge 100 Stück
Werbeschlüssel Schaft MS/L, Stopfen L

Minimum quantity 100 pieces
Advertising code barrel MS/L, plug L





* 06-7527 BIO-MIX: Drücker und Spitze sind aus Bio-Material gefertigt. Der Werkstoff Celluloseacetat entspricht der DIN EN 13432:2000-12 und wird aus europäischen Weichhölzern gewonnen.

* 06-7527 BIO-MIX: Push-button and tip are made of bio material. This material – cellulose acetate – complies with DIN EN 13432:2000-12 and is derived from European softwoods.

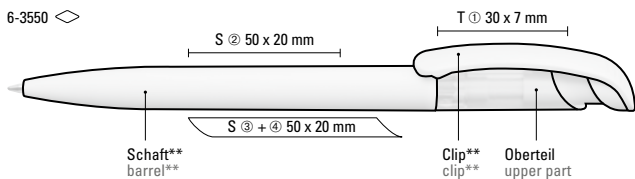

** Die Herstellung der Clips und der Schäfte ist aufgrund des besonderen Materials produktionstechnischen Schwankungen unterlegen. Leichte Unterschiede in der Farbe und der Oberfläche (Schlierenbildung) sind möglich.

** The production of the clips and barrels is subject to fluctuations due to the special material. Slight differences in colour and surface (smear formation) are possible.

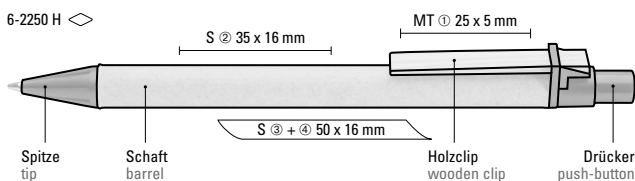

6-3550: Druckkugelschreiber mit Gehäuse und Clip aus 100% nachwachsendem und kompostierbarem Material. Oberteil aus gefrostetem ABS Kunststoff.

6-2250 H: Druckkugelschreiber aus recycelter, naturfarbener Pappe. Spitze und Drücker unifarben aus recyceltem oder biologisch abbaubarem Kunststoff (*06-7527 Bio-Mix) sowie Holzclip.

6-3550: Retractable ballpoint pen with barrel and clip made from 100% renewable biodegradable material. Upper part made from transparent frosted ABS plastic.

6-2250 H: Retractable ballpoint pen made from recycled, natural-coloured cardboard. Tip and push-button uni-coloured made from recycled or biodegradable plastic (*06-7527 Bio-Mix) as well as wooden clip.

6-3550	1.000 Stück
Mindestbestellmenge	Schaft S ◊, Clip T
Werbeschlüssel	
6-2250 H	1.000 Stück
Mindestbestellmenge	Schaft S, Clip MT
Werbeschlüssel	

6-3550	1,000 pieces
Minimum quantity	barrel S ◊, clip T
Advertising code	
6-2250 H	1,000 pieces
Minimum quantity	barrel S, clip MT
Advertising code	





KUNSTSTOFF

PLASTIC



0-0133 (● 8-0855)
0-0133 SI (● 8-0855)



0-0133 T-SI (● 8-0856)

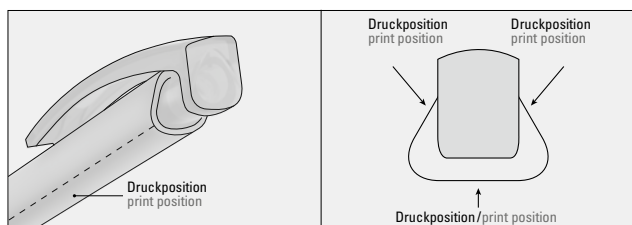

0-0133, 0-0133 SI*, 0-0133 T-SI* ◊

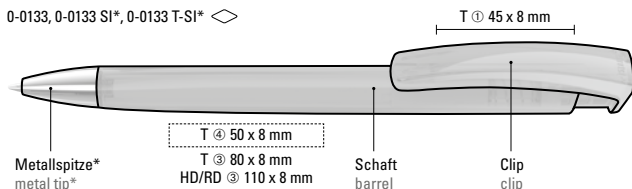

0-0133: Druckkugelschreiber mit gedeckt glänzendem Dreikantgehäuse.

0-0133 SI: Druckkugelschreiber mit gedeckt glänzendem Dreikantgehäuse und schwerer Metallspitze glanzverchromt.

0-0133 T-SI: Druckkugelschreiber mit transparent glänzendem Dreikantgehäuse und schwerer Metallspitze glanzverchromt.

Mindestbestellmenge 1.000 Stück
Werbeschlüssel Schaft T/HD/RD, Clip T

0-0133: Retractable ballpoint pen with opaque glossy triangular housing.

0-0133 SI: Retractable ballpoint pen with opaque glossy triangular housing and heavy metal tip chrome plated.

0-0133 T-SI: Retractable ballpoint pen with transparent glossy triangular housing and heavy metal tip chrome plated.

Minimum quantity 1,000 pieces
Advertising code barrel T/HD/RD, clip T





NFC

Verbinden Sie analoges Schreiben und Werben mittels NFC-Technik mit der interaktiven Welt. Transportieren Sie mit den integrierten uma NFC TAGS nicht mehr nur haptische Werbung, sondern digitale Informationen. Egal ob Kontaktdaten, BusinessCard, Videobotschaften, Produkt- oder Imagefilme, Webseiten oder Social Media Seiten, Verkaufsunterlagen wie Produktkataloge u.v.m.

Connect analogue writing and advertising with the interactive world using NFC technology. With the integrated uma NFC TAGS, go beyond haptic advertising and transmit digital information. Perfect for contact details, BusinessCards, video messages, product or image films, website or social media pages, sales documentation such as product catalogues, etc.

TRINITY GUM
0-0133 GUM

TRINITY SI GUM
0-0133 SI GUM

TRINITY KG SI GUM
0-0133 KG-SI GUM

Farb-Code/Minen
Colour code/Refills



0-0133 GUM (● 8-0855)
0-0133 SI GUM (● 8-0855)

50-0002



0-0133 KG-SI GUM (● 8-0855)

50-2925



50-2388



50-7687



50-7627



50-2420



50-0347



50-0002



50-0429



50-0101



50-0266



50-2039



50-0130



50-1665



50-0326



● 8-0855



0-0133 GUM: Druckkugelschreiber mit gummiertem Dreikantgehäuse und gedeckt glänzendem Clip.

0-0133 SI GUM: Druckkugelschreiber mit gummiertem Dreikantgehäuse, gedeckt glänzendem Clip und schwerer Metallspitze glanzverchromt.

0-0133 KG-SI GUM: Druckkugelschreiber mit gummiertem Dreikantgehäuse, weiß gedeckt glänzendem Clip und schwerer Metallspitze glanzverchromt.

Mindestbestellmenge 1.000 Stück
Werbeschlüssel Schaft GT/HD/RD, Clip T

0-0133 GUM: Retractable ballpoint pen with softtouch triangular housing and opaque glossy clip.

0-0133 SI GUM: Retractable ballpoint pen with softtouch triangular housing, opaque glossy clip and heavy metal tip chrome plated.

0-0133 KG-SI GUM: Retractable ballpoint pen with softtouch triangular housing, opaque glossy clip in white and heavy metal tip chrome plated.

Minimum quantity 1,000 pieces
Advertising code barrel GT/HD/RD, clip T



0-0133 GUM, 0-0133 SI GUM*, 0-0133 KG-SI GUM* ◇

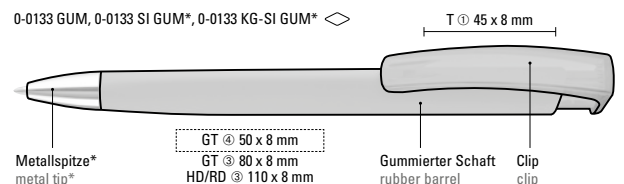

Metallspitze*
metal tip*

GT @ 50 x 8 mm
GT @ 80 x 8 mm
HD/RD @ 110 x 8 mm

Gummiertes Schaft
rubber barrel

Clip
clip

- 0-0133 KT GUM (● 8-0855)
0-0133 KT-SI GUM (● 8-0855)
-  50-2925
 -  50-2388
 -  50-7687
 -  50-7627
 -  50-2420
 -  50-0347
 -  50-0002
 -  50-0429
 -  50-0101
 -  50-0266
 -  50-2039
 -  50-0130
 -  50-1665
 -  50-0326
-  8-0855



UMA
PRIME



RD
uma

0-0133 KT GUM, 0-0133 KT-SI GUM* ◊

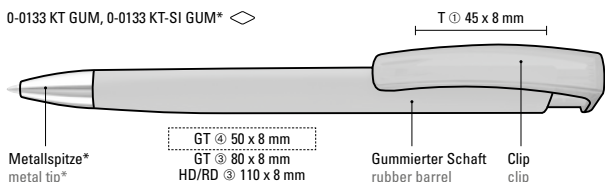

0-0133 KT GUM: Druckkugelschreiber mit gummiertem Dreieckgehäuse und transparent glänzendem Clip.

0-0133 KT-SI GUM: Druckkugelschreiber mit gummiertem Dreieckgehäuse, transparent glänzendem Clip und schwerer Metallspitze glanzverchromt.

Mindestbestellmenge 1.000 Stück
Werbeschlüssel Schaft GT/HD/RD, Clip T

0-0133 KT GUM: Retractable ballpoint pen with softtouch triangular housing and transparent clip.

0-0133 KT-SI GUM: Retractable ballpoint pen with softtouch triangular housing, transparent clip and heavy metal tip chrome plated.

Minimum quantity 1,000 pieces
Advertising code barrel GT/HD/RD, clip T



0-0125 M-SI GUM (● 8-0855)
0-0125 GUM (● 8-0855)

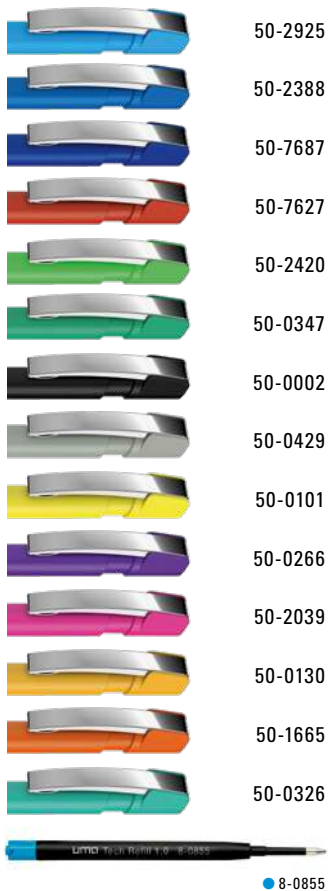

UMA[®]
PRIME



UMA[®]
PRIME



0-0125 M-SI GUM ◊

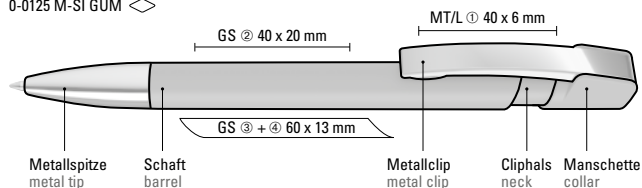

0-0125 M-SI GUM: Druckkugelschreiber mit Softtouch-Gehäuse, flexiblem Metallclip und schwerer Metallspitze glanzverchromt.

0-0125 M-SI GUM: Retractable ballpoint pen with softtouch housing, flexible metal clip and heavy metal tip chrome plated.

0-0125 GUM ◊

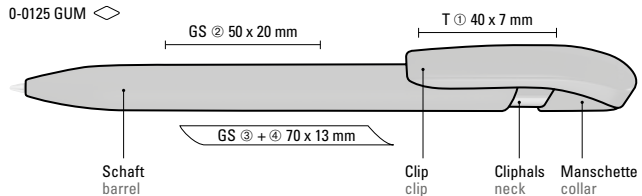

0-0125 GUM: Druckkugelschreiber mit Softtouch-Gehäuse und Manschette, Clip und Cliphals gedeckt glänzend.

0-0125 GUM: Retractable ballpoint pen with softtouch housing and collar, opaque glossy clip and neck.

0-0125 M-SI GUM
Mindestbestellmenge 1.000 Stück
Werbeschlüssel Schaft GS, Clip MT/L

0-0125 GUM
Mindestbestellmenge 1.000 Stück
Werbeschlüssel Schaft GS, Clip T

0-0125 M-SI GUM
Minimum quantity 1,000 pieces
Advertising code barrel GS, clip MT/L

0-0125 GUM
Minimum quantity 1,000 pieces
Advertising code barrel GS, clip T

SKY
0-0125SKY M
0-0125 MSKY M SI
0-0125 M-SIFarb-Code/Minen
Colour code/Refills

UMA
PRIME



UMA
PRIME

0-0125 (● 8-0855)

0-0125 M (● 8-0855)

50-0002

50-0001

50-0072

50-1795

50-2271

50-0356

50-0405

50-0396

50-2077

50-0130

50-0214

50-1585

0-0125 M-SI (● 8-0855)

50-0002

50-0001

● 8-0855

0-0125: Druckkugelschreiber mit gedeckt glänzendem Gehäuse in uni weiß oder schwarz und farbig transparent glänzende Manschette.

0-0125 M: Druckkugelschreiber mit gedeckt glänzendem Gehäuse in uni weiß oder schwarz und farbig transparent glänzendem Cliphals, flexiblem Metallclip glanzverchromt.

0-0125 M-SI: Druckkugelschreiber mit gedeckt glänzendem Gehäuse in uni weiß oder schwarz, flexiblem Metallclip und schwerer Metallspitze glanzverchromt.

0-0125
Mindestbestellmenge 1.000 Stück
Werbeschlüssel Schaft S, Clip T

0-0125 M, 0-0125 M-SI
Mindestbestellmenge 1.000 Stück
Werbeschlüssel Schaft S, Clip MT/L

0-0125: Retractable ballpoint pen with opaque glossy housing in white or black and transparent coloured collar.

0-0125 M: Retractable ballpoint pen with opaque glossy housing in white or black and transparent coloured collar, flexible metal clip chrome plated.

0-0125 M-SI: Retractable ballpoint pen with opaque glossy housing in white or black, flexible metal clip and heavy metal tip chrome plated.

0-0125
Minimum quantity 1,000 pieces
Advertising code barrel S, clip T

0-0125 M, 0-0125 M-SI
Minimum quantity 1,000 pieces
Advertising code barrel S, clip MT/L

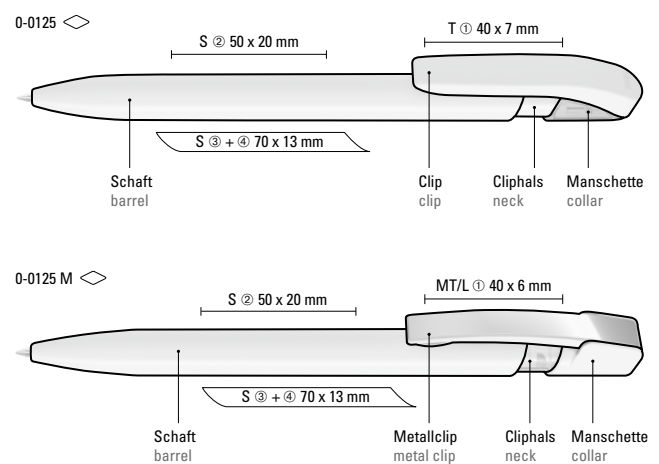

0-0125 TM (● 8-0856)
0-0125 TM-SI (● 8-0856)

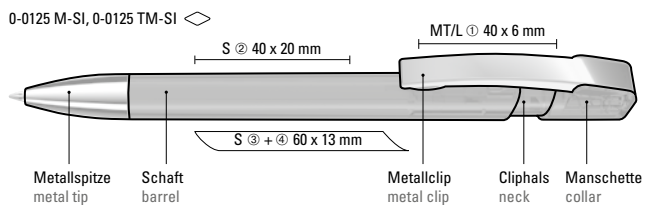
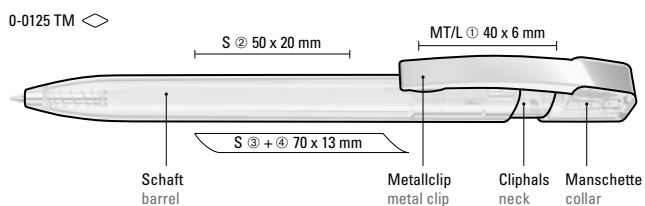
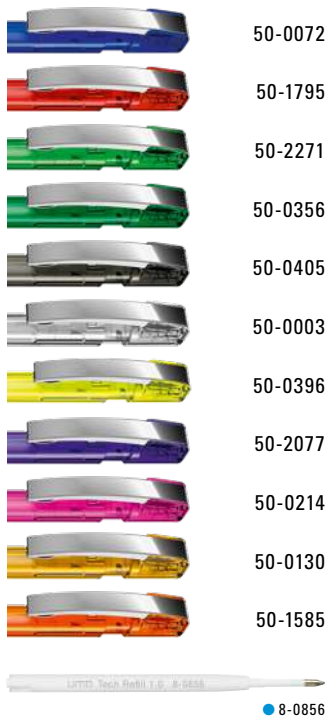

0-0125 TM: Druckkugelschreiber mit transparent glänzendem Gehäuse und flexiblem Metallclip glanzverchromt.

0-0125 TM-SI: Druckkugelschreiber mit transparent glänzendem Gehäuse, flexiblem Metallclip und schwerer Metallspitze glanzverchromt.

Mindestbestellmenge 1.000 Stück
Werbeschlüssel Schaft S, Clip MT/L

0-0125 TM: Retractable ballpoint pen with transparent housing and flexible metal clip chrome plated.

0-0125 TM-SI: Retractable ballpoint pen with transparent housing, flexible metal clip and heavy metal tip chrome plated.

Minimum quantity 1,000 pieces
Advertising code barrel S, clip MT/L



GUMON!



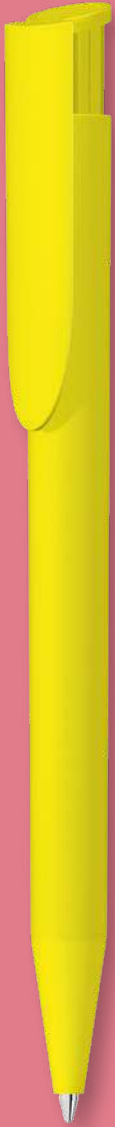

HAPPY GUM
siehe Seite 110
see page 110



TRINITY KT-SI GUM
siehe Seite 84-85
see page 84-85



CORAL GUM
siehe Seite 95
see page 95



SKY M-SI GUM
siehe Seite 87
see page 87



ON TOP GUM
siehe Seite 179
see page 179



ICON M-SI GUM
siehe Seite 191
see page 191

GUMON !

Wenn Schreibgeräte nicht nur spitze aussehen, sondern sich auch noch richtig gut anfühlen – dann halten Sie eines unserer GUM-Modelle in der Hand.



VANE GUM
siehe Seite 181-183
see page 181-183



LUMOS GUM
siehe Seite 247
see page 247



STRAIGHT GUM
siehe Seite 241-242
see page 241-242



ELLIPSE GUM
siehe Seite 237
see page 237



BRUSH GUM
siehe Seite 233
see page 233



VIP GUM
siehe Seite 210
see page 210

GUMON !

*When a writing instrument not only looks great but also feels great,
then you are holding one of our GUM models in your hand.*



0-0177 GUM (● 8-0855)

-  50-2925
-  50-2388
-  50-7687
-  50-7627
-  50-2420
-  50-0347
-  50-0002
-  50-0429
-  50-0101
-  50-0266
-  50-2039
-  50-0130
-  50-1585
-  50-0326
-  8-0855



0-0177 GUM ◊

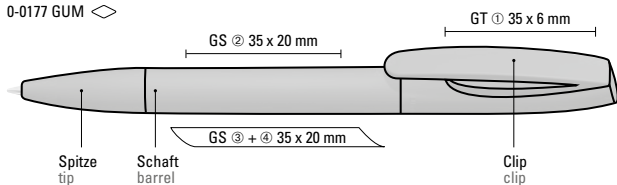

0-0177 GUM: Drehkugelschreiber mit Softtouch-Gehäuse und Softtouch-Clip.
Mindestbestellmenge 1.000 Stück
Werbeschlüssel Schaft GS, Clip GT

0-0177 GUM: Twist ballpoint pen with softtouch housing and softtouch clip.
Minimum quantity 1,000 pieces
Advertising code barrel GS, clip GT



0-0177 SI (● 8-0855)
0-0177 (● 8-0855)

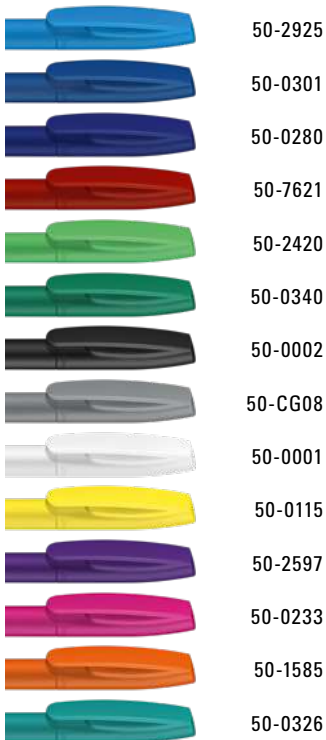

● 8-0855

0-0177 TF-SI (● 8-0856)
0-0177 TF (● 8-0856)



● 8-0856

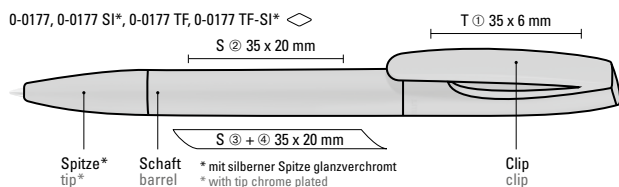

0-0177 SI: Drehkugelschreiber mit matt gedecktem Gehäuse und silberner Spitze glanzverchromt.

0-0177 TF-SI: Drehkugelschreiber mit transparent gefrostetem Gehäuse und silberner Spitze glanzverchromt.

0-0177: Drehkugelschreiber mit matt gedecktem Gehäuse.

0-0177 TF: Drehkugelschreiber mit transparent gefrostetem Gehäuse.

Mindestbestellmenge 1.000 Stück
Werbeschlüssel Schaft S, Clip T

0-0177 SI: Twist ballpoint pen with opaque matt housing and tip chrome plated.

0-0177 TF-SI: Twist ballpoint pen with transparent frosted housing and tip chrome plated.

0-0177: Twist ballpoint pen with opaque matt housing.

0-0177 TF: Twist ballpoint pen with transparent frosted housing.

Minimum quantity 1,000 pieces
Advertising code barrel S, clip T



0-0151 (● 8-0855)



50-0002
50-0001

0-0151 M SI (● 8-0855)

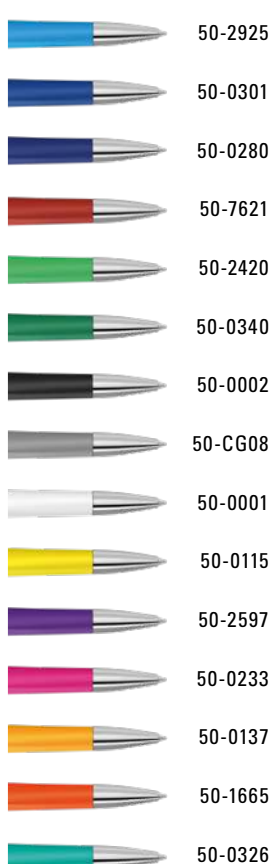

50-2925
50-0301
50-0280
50-7621
50-2420
50-0340
50-0002
50-CG08
50-0001
50-0115
50-2597
50-0233
50-0137
50-1665
50-0326

0-0151: Farben Drücker
0-0151: push-button colours



50-2925
50-0301
50-0280
50-7621
50-2420
50-0340
50-0002
50-CG08
50-0001
50-0115
50-2597
50-0233
50-0137
50-1665
50-0326

● 8-0855

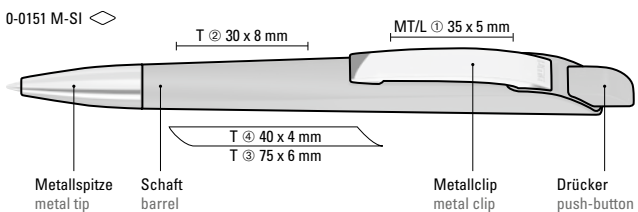
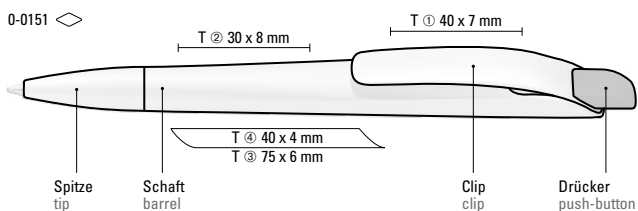

0-0151: Druckkugelschreiber mit geometrisch wechselnder Schaftform. Gehäuse gedeckt matt schwarz oder weiß mit Bogenclip und farbigem Drücker.

0-0151 M-SI: Druckkugelschreiber mit geometrisch wechselnder Schaftform. Gehäuse und Drücker gedeckt matt, Metallclip und Metallspitze glanzverchromt.

0-0151: Retractable ballpoint pen with geometric changes in the barrel. Opaque matt housing in black or white with curved clip and coloured push-button.

0-0151 M-SI: Retractable ballpoint pen with geometric changes in the barrel. Opaque matt housing and push-button, metal clip and metal tip chrome plated.

0-0151
Mindestbestellmenge 1.000 Stück
Werbeschlüssel Schaft T, Clip T
0-0151 M-SI
Mindestbestellmenge 1.000 Stück
Werbeschlüssel Schaft T, Clip MT/L

0-0151
Minimum quantity 1,000 pieces
Advertising code barrel T, clip T
0-0151 M-SI
Minimum quantity 1,000 pieces
Advertising code barrel T, clip MT/L

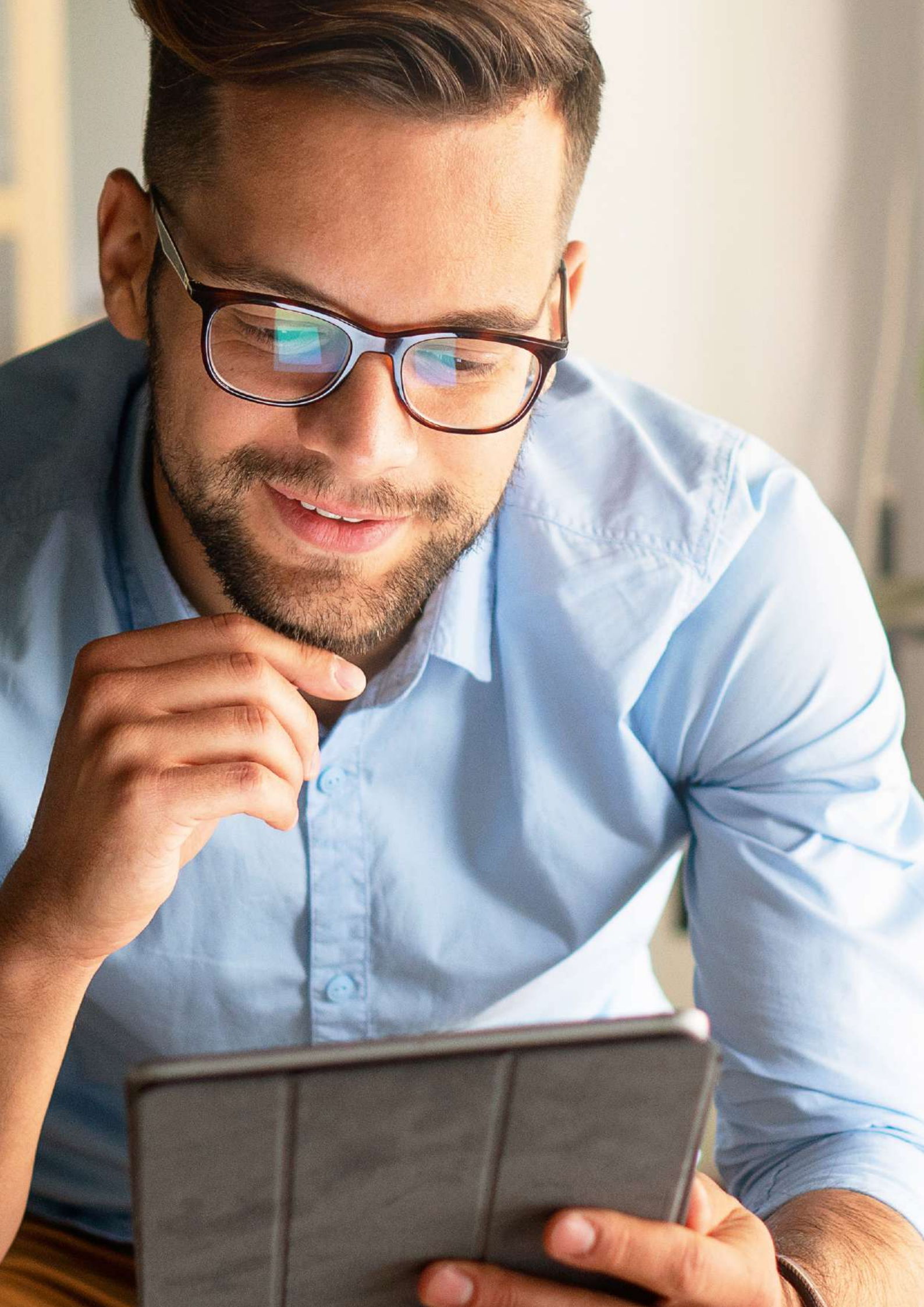

uma Quick Response

Verbinden Sie schnell die haptische, analoge Werbung mit der digitalen Welt. Mittels einem einfachen **uma QR-Code Print** können Sie mit den uma Schreibgeräten einen zusätzlichen Kommunikationskanal öffnen. Über den **QR-Code Scan** gelangen die User schnell auf eine vom Kunden definierte Landingpage. So wird schnelle und messbare Response geschaffen, die durch das Schreibgerät angetrieben wird.

Der **uma QR-Code Print** kann auf verschiedenen Modellen in verschiedenen Positionen und auch mittels verschiedener Drucktechniken bis hin zur Lasertechnik umgesetzt werden.

It's never been easier to connect haptic, analogue marketing to the digital world. All made possible thanks to a simple, **uma QR-Code Print**. Gain a new communication channel with your uma pens. Users just need to scan the **QR** code to quickly access the defined landing page. Achieve quick and measurable responses driven by pens.

uma QR codes can be printed in a range of positions on various models using several available printing methods, including laser technology.



UMA
QR-Code Print
for **Quick Response**

QR-CODE



0-0154 SI (● 8-0855)

0-0154 TF-SI (● 8-0856)



Einzigartiger Vierkantschaft, welcher sich im Griffbereich in eine angenehm greifende, runde Schaftform verwandelt.

Unique four-edged barrel, which transforms into a pleasant round barrel shape in the grip area.

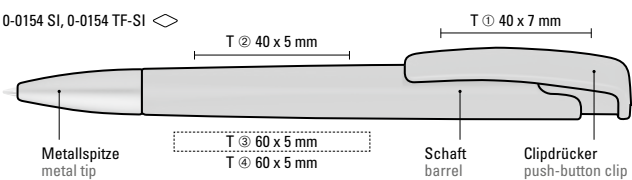
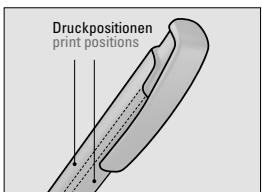

0-0154 SI: Druckkugelschreiber mit geometrisch wechselnder Schaftform, matt gedecktem Gehäuse und Metallspitze matt verchromt.

0-0154 TF-SI: Druckkugelschreiber mit geometrisch wechselnder Schaftform, transparent gefrostetem Gehäuse und Metallspitze matt verchromt.

Mindestbestellmenge
Werbeschlüssel

1.000 Stück
Schaft T, Clip T

0-0154 SI: Retractable ballpoint pen with geometric changes in the barrel, opaque matt housing and metal tip matt chrome plated.

0-0154 TF-SI: Retractable ballpoint pen with geometric changes in the barrel, transparent frosted housing and metal tip matt chrome plated.

Minimum quantity
Advertising code

1,000 pieces
barrel T, clip T



0-0092 TF (● 8-0854)
0-0092 TF-SI (● 8-0840)



*feel the
FlowMotion*



UMA
PRIME

UMA
PRIME



Recyclete
Variante
YES RECY

Seite /page 53

UMA FlowMotion®

Mit der neuen uma FlowMotion® Schreibtechnologie. Siehe Seite 305.
With the new uma FlowMotion® writing technology. See on page 305.

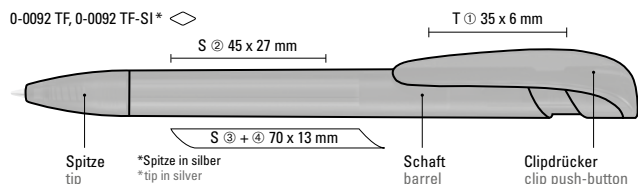

0-0092 TF: Druckkugelschreiber mit transparent gefrostetem Gehäuse, breitem Bogenclipdrücker und Spitze.

0-0092 TF-SI: Druckkugelschreiber mit transparent gefrostetem Gehäuse, breitem Bogenclipdrücker und silberner Spitze glanzverchromt.

Mindestbestellmenge 1.000 Stück
Werbeschlüssel Schaft S O, Clip T

0-0092 TF: Retractable ballpoint pen with transparent frosted housing, wide curved clip button and tip.

0-0092 TF-SI: Retractable ballpoint pen with transparent frosted housing, wide curved clip button and tip chrome plated.

Minimum quantity 1,000 pieces
Advertising code barrel S O, clip T



Mix n' Match: Ab 2.000 Stück kann das Modell farblich kombiniert werden. Aufpreis für Kombimodell 0-0092 F V auf Anfrage.

Mix n' Match: From 2,000 pieces, you can choose any colour combination. Additional charge for combination model 0-0092 F V on request.

0-0092 F (● 8-0854)
0-0092 F-SI (● 8-0840)



UMA
PRIME



UMA
PRIME



*feel the
FlowMotion*



Recyclete
Variante
YES RECY

Seite /page 53

UMA FlowMotion®

Mit der neuen uma FlowMotion® Schreibtechnologie. Siehe Seite 305.
With the new uma FlowMotion® writing technology. See on page 305.

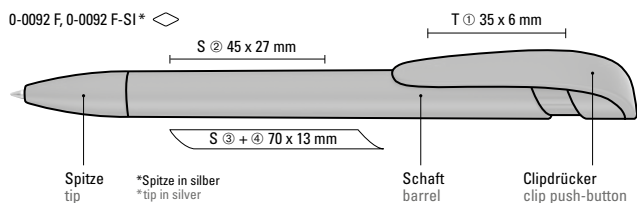

0-0092 F: Druckkugelschreiber mit gedeckt mattem Gehäuse, breitem Bogenclipdrücker und Spitze.

0-0092 F-SI: Druckkugelschreiber mit gedeckt mattem Gehäuse, breitem Bogenclipdrücker und silberner Spitze glanzverchromt.

Mindestbestellmenge 1.000 Stück
Werbeschlüssel Schaft S ○, Clip T

0-0092 F: Retractable ballpoint pen with opaque matt housing, wide curved clip button and tip.

0-0092 F-SI: Retractable ballpoint pen with opaque matt housing, wide curved clip button and tip chrome plated.

Minimum quantity 1,000 pieces
Advertising code barrel S ○, clip T

YES SI
0-0093 SI

YES transparent SI
0-0093 T-SI

YES LUX SI
0-0093 LUX SI

Farb-Code/Minen
Colour code/Refills



UMA[®]
PRIME



UMA[®]
PRIME



0-0093 SI (● 8-0855)

50-0002

50-0001

● 8-0855

0-0093 T-SI (● 8-0856)

50-2925

50-0072

50-1795

50-2271

50-0356

50-0405

50-0003

50-0396

50-2077

50-0214

50-0130

50-1585

50-0326

50-0483

● 8-0856

0-0093 LUX SI (● 8-0855)

50-0004

● 8-0855



Antibakterielle Variante

YES ANTIBAC

Seite /page 53

0-0093 SI: Druckkugelschreiber mit gedeckt glänzendem Gehäuse in schwarz oder weiß, breitem Bogenclipdrücker und schwerer Metallspitze glanzverchromt.

0-0093 T-SI: Druckkugelschreiber mit transparent glänzendem Gehäuse, breitem Bogenclipdrücker und schwerer Metallspitze glanzverchromt.

0-0093 LUX SI: Druckkugelschreiber mit gedeckt glänzendem Gehäuse in silber, breitem Bogenclipdrücker und schwerer Metallspitze glanzverchromt.

Mindestbestellmenge 1.000 Stück
Werbeschlüssel Schaft S ○, Clip T

0-0093 SI: Retractable ballpoint pen with opaque glossy housing in black or white, wide curved clip button and heavy metal tip chrome plated.

0-0093 T-SI: Retractable ballpoint pen with transparent housing, wide curved clip button and heavy metal tip chrome plated.

0-0093 LUX SI: Retractable ballpoint pen with opaque glossy housing in silver, wide curved clip button and heavy metal tip chrome plated.

Minimum quantity 1,000 pieces
Advertising code barrel S ○, clip T

0-0093 SI, 0-0093 T-SI, 0-0093 LUX SI ◇

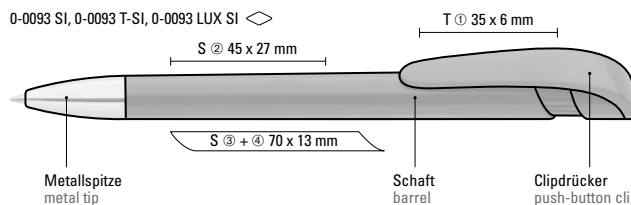

Farb-Code/Minen
Colour code/Refills

YES
0-0093

YES transparent
0-0093 T

YES LUX
0-0093 LUX

109

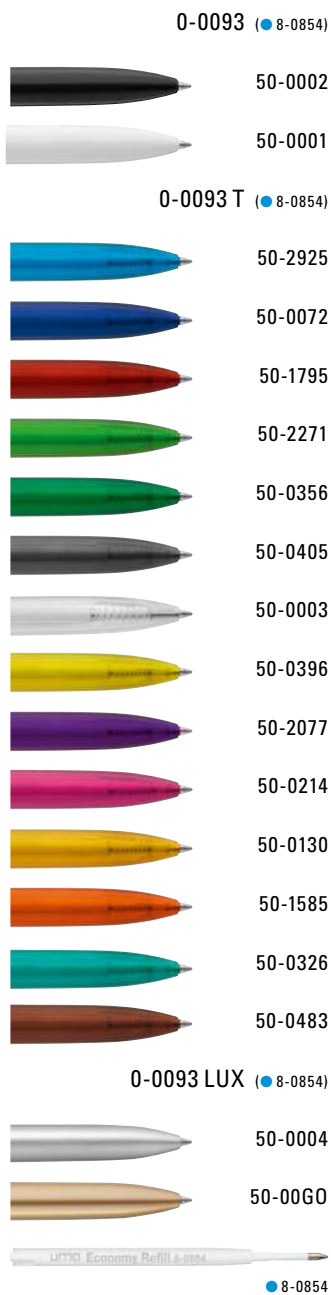

YES



Antibakterielle
Variante
YES ANTIBAC
Seite/page 53

0-0093, 0-0093 T, 0-0093 LUX ◊

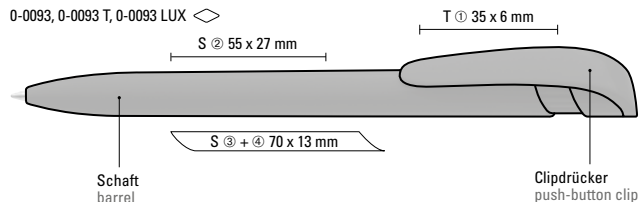

0-0093: Druckkugelschreiber mit gedeckt glänzendem Gehäuse in schwarz oder weiß und breitem Bogenclipdrücker.

0-0093 T: Druckkugelschreiber mit transparent glänzendem Gehäuse und breitem Bogenclipdrücker.

0-0093 LUX: Druckkugelschreiber mit gedeckt glänzendem Gehäuse in silber oder gold und breitem Bogenclipdrücker.

Mindestbestellmenge 1.000 Stück
Werbeschlüssel Schaft S ◊, Clip T

0-0093: Retractable ballpoint pen with opaque glossy housing in black or white and wide curved clip button.

0-0093 T: Retractable ballpoint pen with transparent housing and wide curved clip button.

0-0093 LUX: Retractable ballpoint pen with opaque glossy housing in silver or gold and wide curved clip button.

Minimum quantity 1,000 pieces
Advertising code barrel S ◊, clip T

HAPPY
0-0037

HAPPY GUM
0-0037 GUM

Farb-Code/Minen
Colour code/Refills



0-0037 (● 8-0865)
0-0037 GUM (● 8-0865)

- 20-2925
 - 20-0301
 - 20-0280
 - 20-7621
 - 20-2420
 - 20-0340
 - 20-0002
 - 20-CG08
 - 20-0001*
 - 20-0115
 - 20-2597
 - 20-0233
 - 20-1585
 - 20-0326
- 8-0865

* Farbe nicht für 0-0037 GUM erhältlich
Colour not available for 0-0037 GUM



Recycelte Variante
HAPPY RECY
Seite/page 59

0-0037: Druckkugelschreiber mit gedeckt mattem Gehäuse und Clipdrücker.

0-0037 GUM: Druckkugelschreiber mit Softtouch-Gehäuse und Softtouch-Clipdrücker.

0-0037
Mindestbestellmenge 1.000 Stück
Werbeschlüssel Schaft S ○, Clip T

0-0037 GUM
Mindestbestellmenge 1.000 Stück
Werbeschlüssel Schaft GS, Clip GT

0-0037: Retractable ballpoint pen with opaque matt housing and clip button.

0-0037 GUM: Retractable ballpoint pen with softtouch housing and softtouch clip button.

0-0037
Minimum quantity 1,000 pieces
Advertising code barrel S ○, clip T

0-0037 GUM
Minimum quantity 1,000 pieces
Advertising code barrel GS, clip GT

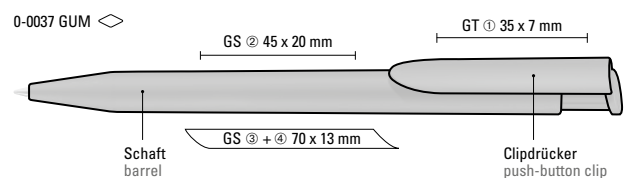
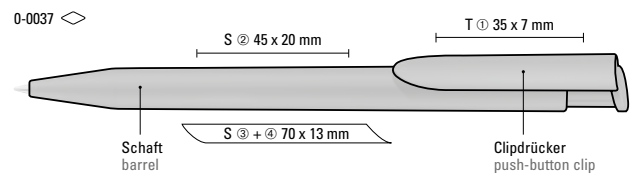

0-0037 TF (● 8-0865)

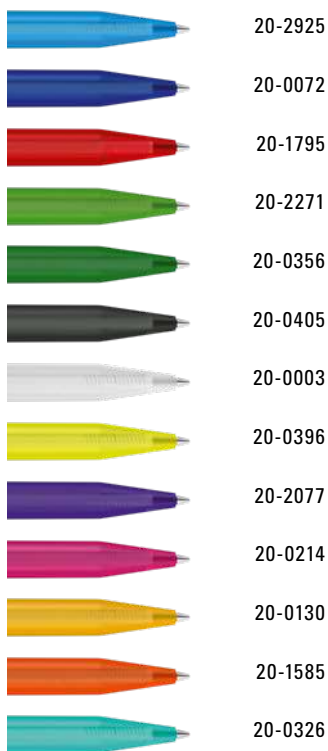

0-0037 KTF (● 8-0865)

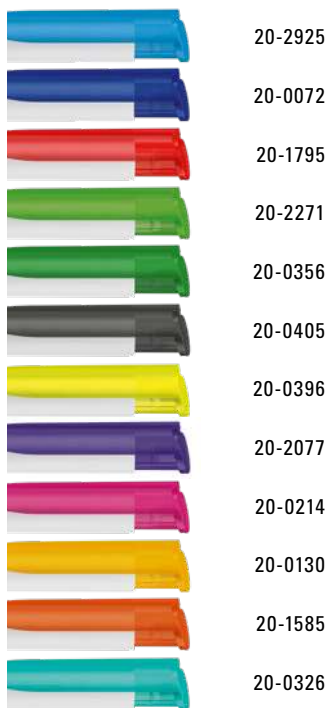

Recycelte
Variante
HAPPY RECY
Seite/page 59

0-0037 TF, 0-0037 K-TF* ◊

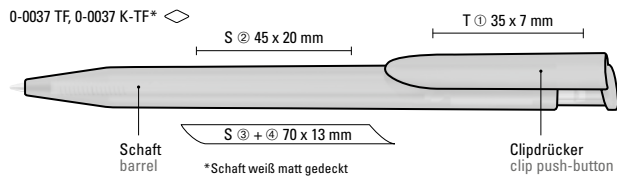

0-0037 TF: Druckkugelschreiber mit transparent gefrostetem Gehäuse und Clipdrücker.

0-0037 KTF: Druckkugelschreiber mit gedeckt mattem Gehäuse in weiß und farbig transparent gefrostetem Clipdrücker.

Mindestbestellmenge 1.000 Stück
Werbeschlüssel Schaft S ◊, Clip T

0-0037 TF: Retractable ballpoint pen with transparent frosted housing and clip button.

0-0037 KTF: Retractable ballpoint pen with opaque matt housing in white and coloured transparent frosted clip button.

Minimum quantity 1,000 pieces
Advertising code barrel S ◊, clip T



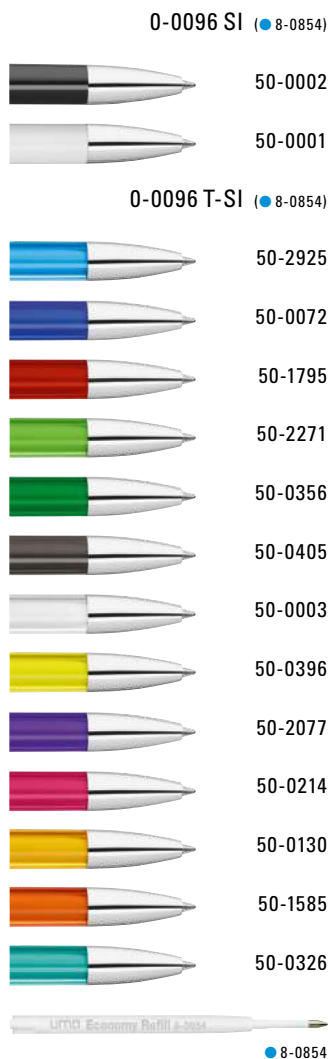

UMA
PRIME



UMA
PRIME

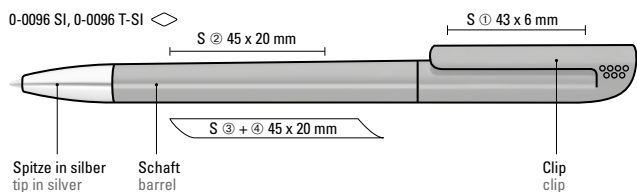

0-0096 SI: Drehkugelschreiber mit gedeckt glänzendem Gehäuse, matter Clipoberfläche und Spitze glanzverchromt.

0-0096 T-SI: Drehkugelschreiber mit transparent glänzendem Gehäuse, gefrosteter Clipoberfläche und Spitze glanzverchromt.

Mindestbestellmenge 1.000 Stück
Werbeschlüssel Schaft S, Clip S

0-0096 SI: Twist ballpoint pen with opaque glossy housing, matt clip surface and tip chrome plated.

0-0096 T-SI: Twist ballpoint pen with transparent housing, matt clip surface and tip chrome plated.

Minimum quantity 1,000 pieces
Advertising code barrel S, clip S

TWISTY SI
0-0040 SI

TWISTY frozen
0-0040 TF

Farb-Code/Minen
Colour code/Refills



0-0040 SI (● 8-0854)

58-0004



0-0040 TF (● 8-0854)

50-2925



50-0072



50-1795



50-2271



50-0356



50-0405



50-0003



50-0396



50-2077



50-0130



50-0214



50-1585



● 8-0854

0-0040 SI: Drehkugelschreiber mit gedeckt mattem Gehäuse in silber.
0-0040 TF: Drehkugelschreiber mit transparent gefrostetem Gehäuse.

Mindestbestellmenge 1.000 Stück
Werbeschlüssel Schaft S ○, Clip S

0-0040 SI: Twist ballpoint pen with opaque matt housing in silver.
0-0040 TF: Twist ballpoint pen with transparent frosted housing.

Minimum quantity 1,000 pieces
Advertising code barrel S ○, clip S

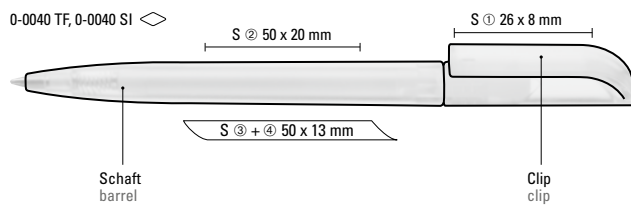

- 0-0077 (● 8-0865)
- 20-0002
- 20-0001
- 0-0077 T (● 8-0865)
- 20-2925
- 20-7687
- 20-1795
- 20-2420
- 20-0347
- 20-0405
- 20-0003
- 20-0101
- 20-0266
- 20-2039
- 20-0130
- 20-1665
- 20-0326
- 8-0865

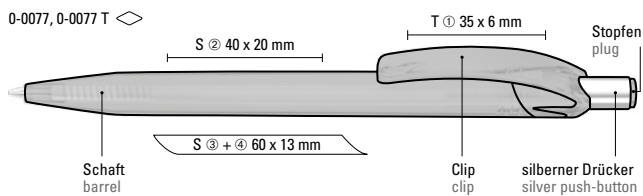

0-0077: Druckkugelschreiber mit glänzend gedecktem Gehäuse und Drückerstopfen in schwarz oder weiß. Drücker in silber glänzend.

0-0077 T: Druckkugelschreiber mit glänzend transparentem Gehäuse und Drückerstopfen. Drücker in silber glänzend.



Mindestbestellmenge 1.000 Stück
Werbeschlüssel Schaft S, Clip T

0-0077: Retractable ballpoint pen with opaque glossy housing and plug in black or white. Push-button silver glossy.

0-0077 T: Retractable ballpoint pen with transparent housing and plug. Push-button silver glossy.

Minimum quantity 1,000 pieces
Advertising code barrel S, clip T



0-0087 (● 8-0866)	
	44-0002
	44-0001
	44-2925
	44-0281
	44-0187
	44-0356
	44-0011
	44-0421
	44-0116
	44-0165
	44-0326
	● 8-0866

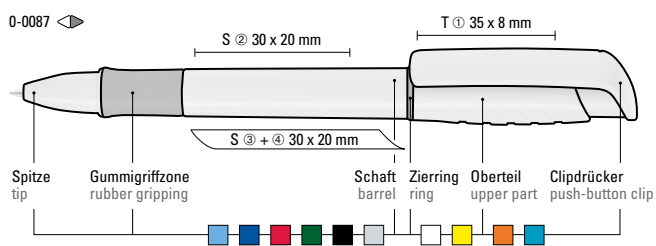

Mix n' Match: Ab 2.000 Stück kann das Modell farblich kombiniert werden.

0-0087: Druckkugelschreiber mit gedeckt glänzendem Gehäuse in weiß, Griffzone und Zierring farbig oder unifarben gedeckt glänzend schwarz.

Mindestbestellmenge 1.000 Stück
Werbeschlüssel Schaft S, Clip T

Mix n' Match: From 2,000 pieces, you can choose any colour combination.

0-0087: Retractable ballpoint pen with opaque glossy housing in white, grip zone and decorative ring coloured or opaque glossy black.

Minimum quantity 1,000 pieces
Advertising code barrel S, clip T

X-DREAM
0-0090

X-DREAM CO SM
0-0090 CO-SM

X-DREAM SK
0-0090 SK

Farb-Code/Minen
Colour code/Refills



0-0090 (● 8-0855)
0-0090 SK (● 8-0855)



0-0090 CO-SM (● 8-0855)

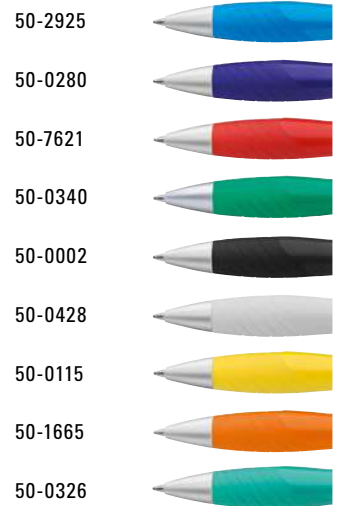

0-0090: Druckkugelschreiber mit gedeckt mattem Gehäuse, Bogenclipdrücker und Spitze in weiß, ergonomische, farbige Gummigriffzone.

0-0090 CO-SM: Druckkugelschreiber mit gedeckt glänzendem Gehäuse, Bogenclipdrücker, ergonomische Gummigriffzone und Metallspitze matt verchromt.

0-0090 SK: Druckkugelschreiber mit gedeckt mattem Gehäuse, individuell gestaltbarem Clipdrücker, Spitze und ergonomischer Gummigriffzone. Motivgröße nach Absprache, max.: ca. 30 x 20 x 2,2mm.

0-0090, 0-0090 CO-SM	
Mindestbestellmenge	1.000 Stück
Werbeschlüssel	Schaft S, Clip T
0-0090 SK	
Mindestbestellmenge	10.000 Stück
Werbeschlüssel	Schaft S, Clip T

0-0090: Retractable ballpoint pen with opaque matt housing, curved clip push-button and tip in white, ergonomic coloured rubber grip zone.

0-0090 CO-SM: Retractable ballpoint pen with opaque glossy housing, curved clip button, ergonomic coloured rubber grip zone and metal tip matt chrome plated.

0-0090 SK: Retractable ballpoint pen with opaque matt housing, clip button individual designed, ergonomic coloured rubber grip zone and tip. Clip size on demand approx.: ca. 30 x 20 x 2,2mm

0-0090 SI, 0-0090 CO-SM	
Minimum quantity	1,000 pieces
Advertising code	barrel S, clip T
0-0090 SK	
Minimum quantity	10,000 pieces
Advertising code	barrel S, clip T

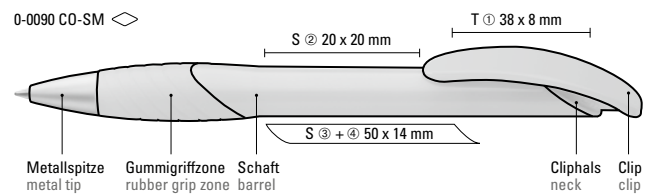
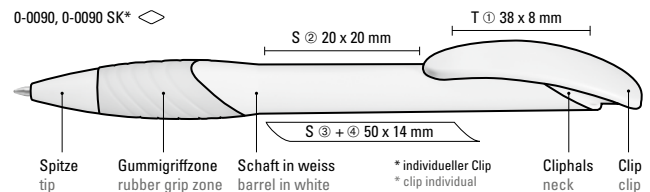

0-0090 T-SM (● 8-0856)
0-0090 TF (● 8-0856)

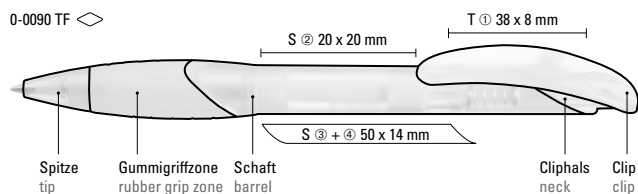
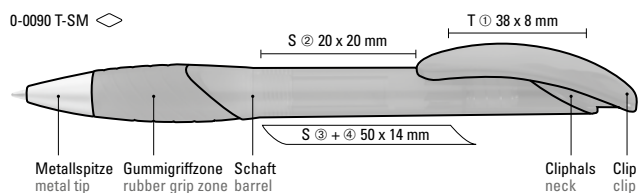
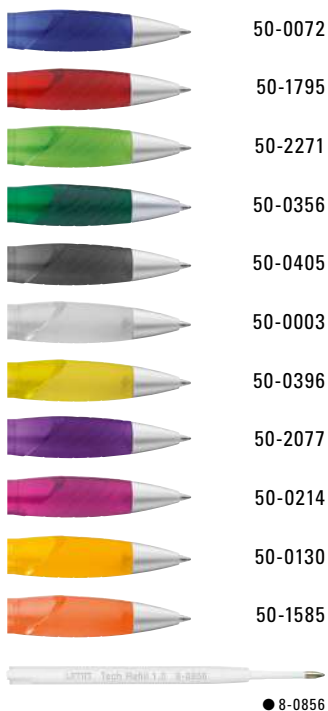

0-0090 T-SM: Druckkugelschreiber mit transparent glänzendem Gehäuse, Bogenclipdrücker, ergonomischer Gummigriffzone und Metallspitze mattverchromt.

0-0090 TF: Druckkugelschreiber mit transparent gefrostetem Gehäuse, Bogenclipdrücker und Spitze, ergonomische Gummigriffzone.

Mindestbestellmenge 1.000 Stück
Werbeschlüssel Schaft S, Clip T

0-0090 T-SM: Retractable ballpoint pen with transparent housing, curved clip button, ergonomic coloured rubber grip zone and metal tip matt chrome plated.

0-0090 TF: Retractable ballpoint pen with transparent frosted housing, curved clip button and tip, ergonomic coloured rubber grip zone.

Minimum quantity 1,000 pieces
Advertising code barrel S, clip T

Ihr Lieblingsschreibgerät aus dem Schwarzwald

Die uma BlackForestPens verbinden eindrucksvoll zeitloses Design mit hochwertiger Verarbeitung und Fertigungstechnik. Die in Deutschland designten Modelle werden mit Schweizer Präzision gefertigt. Alle Einzelteile werden dann in Fischerbach, im Herzen des Schwarzwaldes, zu einem individuellen Lieblingsschreibgerät zusammengeführt. Dass die uma BlackForestPens nicht nur einwandfrei schreiben, sondern auch noch bestens Werben, dafür sorgt ein europaweit einzigartiger Veredelungspark in Fischerbach.

Mit viel Liebe zum Detail entsteht so eine besondere uma Schreibgeräte-Kollektion, die den Schwarzwälder Qualitätsgedanken weit über die Landesgrenzen hinaus positiv kommuniziert. Langlebiges Schreiben und auffallend einzigartiges Werben trifft auf ressourcenschonende Fertigungstechnik und kurze Lieferwege.



Your favourite writing instrument made in the black forest

The uma BlackForestPens impressively combine timeless design with high-quality processing and manufacturing technology. The models designed in Germany are manufactured with Swiss precision. All individual parts are merged together in Fischerbach, in the heart of the Black Forest, to create your individual favourite writing instrument. The uma BlackForestPens not only writing flawlessly, they can also advertise well, thanks to a Europe-wide unique refinement park in Fischerbach.

With a lot of love for detail, a special uma writing instrument collection is created, which is communicated the Black Forest quality ideas positively far beyond the borders of the country. Durable writing and conspicuously unique advertising meet resource-conserving manufacturing technology and short delivery routes.

Mix n' Match

Gleich und gleich gesellt sich gern. Und Gegensätze ziehen sich an. Bei uma muss das kein Widerspruch sein. Denn mit einer nahezu unerschöpflichen Palette an Kombinationsmöglichkeiten können Sie Ihr Schreibgerät in den buntesten Farben erstrahlen lassen – individueller geht's nicht!

Mix n' Match

Like attracts like! And opposites attract another! At uma, this doesn't have to be a contradiction. Because with an almost inexhaustible range of combination possibilities you can let your writing instrument shine in the brightest colours – It couldn't be more individual!

umaBlackForest
Pens

Schreiben auch Sie ein Stück Schwarzwald Geschichte.
Write a piece of Black Forest history.

Heimatverliebt und qualitätsbewusst – umaBlackForestPens!

Homely and quality conscious – umaBlackForestPens!

Geschmackvoll designt in **Deutschland**.
Präzise gefertigt in der **Schweiz**.
Exklusiv zusammengefügt und veredelt im **Schwarzwald**.

*Elegant designed in **Germany**.
Precisely manufactured in **Switzerland**.
Exclusively assembled and refined in the **Black Forest**.*

Zeitgemäßer, designorientierter Werbeträger

Contemporary modern advertising medium

Hochwertige Verarbeitung

High quality manufacture

Mix n' Match individuelle Konfiguration möglich

Mix n' Match individual configuration possible

Kurze Lieferwege

Short delivery routes

Langlebige Mine uma Tech Refill

Long-capacity refill uma Tech Refill

484.754 Farbkombinationsmöglichkeiten
different colour combination options

10 Familien
families



Auch als **RECY-Varianten** erhältlich

*Also available as **RECY versions***

3 verschiedene Oberflächen
different surfaces

umaBlackForest
Pens

Die schönste Verbindung von Design und Fertigung.

The most beautiful combination of design and manufacturing.

**CHECK**

siehe Seite 124-127
see page 124-127

**CHILL**

siehe Seite 129
see page 129

**ULTIMO**

siehe Seite 130
see page 130

**ULTIMATE**

siehe Seite 131
see page 131

**PEPP**

siehe Seite 132
see page 132



SPOT
siehe Seite 133
see page 133



CHIC
siehe Seite 134
see page 134



CETA
siehe Seite 135
see page 135































CRYSTAL
siehe Seite 137
see page 137



GEOS
siehe Seite 139
see page 139



1-0142 M-SI (●● 8-0855)	1-0142 TF M-SI (●● 8-0856)
 01-0284	 01-0306
 01-0286	 01-2747
 01-0280	 01-0199
 01-0200	 01-0802
 01-0375	 01-0336
 01-0340	 01-0425
 01-0002	 01-0003
 01-0428	 01-0116
 01-0001	 01-0268
 01-0108	 01-0227
 01-0526	 01-0151
 01-0219	 8-0856
 01-0172	
 01-2995	
 01-3262	
 8-0855	



umaBlackForest Pens

Die schönste Verbindung von Design und Fertigung. Geschmackvoll design in Deutschland. Präzise gefertigt in der Schweiz. Exklusiv zusammengefügt und veredelt im Schwarzwald.

The most beautiful combination of design and manufacturing. Elegant designed in Germany. Precisely manufactured in Switzerland. Exclusively assembled and refined in the Black Forest.

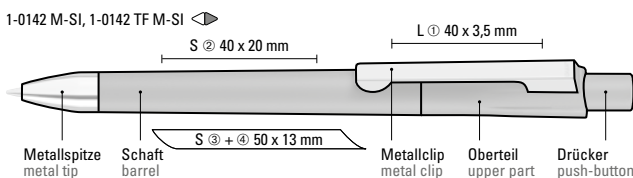

Mix n' Match: Alle Teile können farblich frei kombiniert werden.

1-0142 M-SI: Druckkugelschreiber mit gedeckt matten Gehäuse. Schwerer Metallschreiber und Metallschreiber glanzverchromt.

1-0142 TF M-SI: Druckkugelschreiber mit transparent gefrosteten Gehäuse. Schwere Metallschreiber und Metallschreiber glanzverchromt.

Mindestbestellmenge 1.000 Stück
Werbeschlüssel Schaft S ○, Clip L

Mix n' Match: All parts can be colour-combined freely.

1-0142 M-SI: Retractable ballpoint pen with opaque matt housing. Heavy metal tip and metal clip chrome plated.

1-0142 TF M-SI: Retractable ballpoint pen with transparent frosted housing. Heavy metal tip and metal clip chrome plated.

Minimum quantity 1,000 pieces
Advertising code barrel S ○, clip L

CHECK SI
1-0142 SICHECK K frozen SI
1-0142 KTF SIFarb-Code/Minen
Colour code/Refills

1-0142 SI (●● 8-0855)

1-0142 KTF SI (●● 8-0855)

01-0284



01-0286



01-0280



01-0200



01-0375



01-0340



01-0002



01-0428



01-0001



01-0108



01-0526



01-0219



01-0172



01-2995



01-3262



●● 8-0855

Mix n' Match: Alle Teile können farblich frei kombiniert werden.

1-0142 SI: Druckkugelschreiber mit gedeckt matten Gehäuse und schwerer Metallspitze matt verchromt.

1-0142 KTF SI: Druckkugelschreiber mit gedeckt matten Gehäuse und transparent gefrostetem Clip. Schwere Metallspitze matt verchromt.

Mindestbestellmenge 1.000 Stück
Werbeschlüssel Schaft S ○, Clip T

Mix n' Match: All parts can be colour-combined freely.

1-0142 SI: Retractable ballpoint pen with opaque matt housing and heavy metal tip matt chromed.

1-0142 KTF SI: Retractable ballpoint pen with opaque matt housing and transparent frosted clip. Heavy metal tip matt chromed.

Minimum quantity 1,000 pieces
Advertising code barrel S ○, clip T

umaBlackForest Pens

1-0142 SI, 1-0142 KTF SI ◀

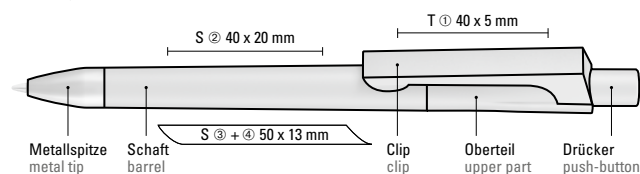

1-0142 TF-SI (●●8-0856)
1-0142 TF KG SI (●●8-0856)

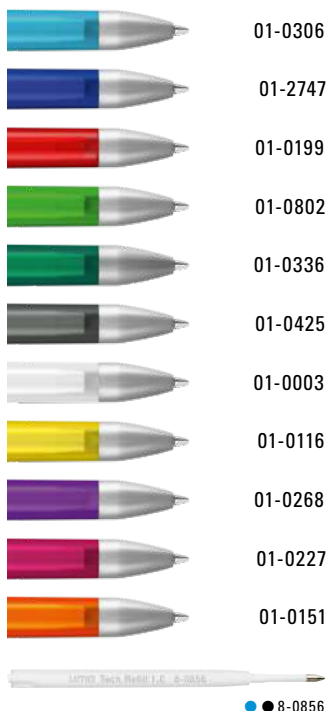

umaBlackForest Pens

1-0142 TF-SI, 1-0142 TF KG SI ◀

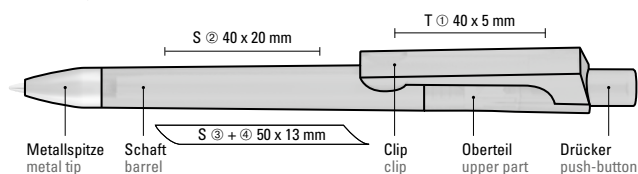

Mix n' Match: Alle Teile können farblich frei kombiniert werden.

1-0142 TF-SI: Druckkugelschreiber mit transparent gefrosteten Gehäuse und schwere Metallspitze matt verchromt.

1-0142 TF KG SI: Druckkugelschreiber mit transparent gefrosteten Gehäuse und gedeckt mattem Clip in weiß. Schwere Metallspitze matt verchromt.

Mindestbestellmenge 1.000 Stück
Werbeschlüssel Schaft S ○, Clip T

Mix n' Match: All parts can be colour-combined freely.

1-0142 TF-SI: Retractable ballpoint pen with transparent frosted housing and heavy metal tip matt chromed.

1-0142 TF KG SI: Retractable ballpoint pen with transparent frosted housing and opaque matt clip in white. Heavy metal tip matt chromed.

Minimum quantity 1,000 pieces
Advertising code barrel S ○, clip T



1-0043 SI (●●8-0855)
1-0043 C-SI (●●8-0855)



1-0043 T-SI (●●8-0856)
1-0043 CT-SI (●●8-0856)



Mit weichem Drehmechanismus
With soft twist mechanism

umaBlackForest Pens

1-0043 SI, 1-0043 T-SI, 1-0043 C-SI, 1-0043 CT-SI ◊

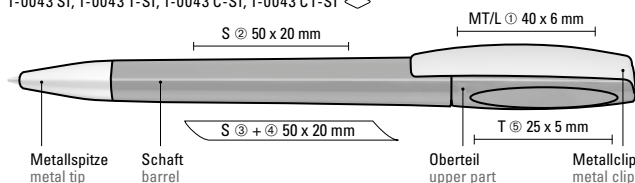

POST-CONSUMER
RECYCLED PLASTIC

Recycelte Variante
CHILL C-SI RECY
Seite/page 66



1-0043 SI: Drehkugelschreiber mit
gedeckt glänzendem Gehäuse.
Metallclip und schwere Metallspitze
glanzverchromt.

1-0043 T-SI: Drehkugelschreiber mit
transparent glänzendem Gehäuse.
Metallclip und schwere Metallspitze
glanzverchromt.

1-0043 C-SI: Drehkugelschreiber mit
gedeckt glänzendem Gehäuse. Metallclip
und schwere Metallspitze matt
verchromt.

1-0043 CT-SI: Drehkugelschreiber mit
transparent glänzendem Gehäuse.
Metallclip und schwere Metallspitze
verchromt.

Mindestbestellmenge 1.000 Stück
Werbeschlüssel Schaft S ◊,
Clip MT/L, Oberteil T

1-0043 SI: Twist ballpoint pen with
opaque glossy housing. Metal clip and
heavy metal tip chrome plated.

1-0043 T-SI: Twist ballpoint pen with
transparent housing. Metal clip and
heavy metal tip chrome plated.

1-0043 C-SI: Twist ballpoint pen with
opaque glossy housing. Metal clip and
heavy metal tip matt chromed.

1-0043 CT-SI: Twist ballpoint pen with
transparent housing. Metal clip and
heavy metal tip matt chromed.

Minimum quantity 1,000 pieces
Advertising code barrel S ◊,
clip MT/L, upper part T

ULTIMO SI
1-0047 SI

ULTIMO transparent SI
1-0047 T-SI

Farb-Code/Minen
Colour code/Refills



1-0047 SI (● 8-0855)

01-0002



01-0001



● 8-0855

1-0047 T-SI (● 8-0856)

01-2747



01-0199



01-0336



01-0425



01-0003



01-0116



01-0268



01-0227



01-0151



● 8-0856



1-0047 SI: Drehkugelschreiber mit gedeckt glänzendem Gehäuse in weiß oder schwarz und silbernem Stopfen im Oberteil. Schwere Metallspitze glanzverchromt.

1-0047 T-SI: Drehkugelschreiber mit transparent glänzendem Gehäuse und silbernem Stopfen im Oberteil. Schwere Metallspitze glanzverchromt.

Mindestbestellmenge 1.000 Stück
Werbeschlüssel Schaft S ○, Clip T







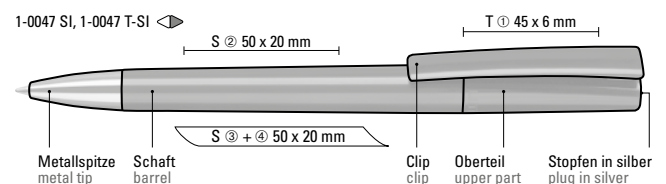

























1-0047 SI: Twist ballpoint pen with opaque glossy housing in white or black and silver plug. Heavy metal tip chrome plated.

1-0047 T-SI: Twist ballpoint pen with transparent housing and silver plug. Heavy metal tip chrome plated.

Minimum quantity 1,000 pieces
Advertising code barrel S ○, clip T



umaBlackForest
Pens

1-0048 SI (●● 8-0855)	1-0048 SI, 1-0048 TF-SI, Stopfen ABS plug ABS	
 01-0002	 01-0001	 01-0004
 ●● 8-0855	 01-0284	 01-0286
1-0048 TF-SI (●● 8-0856)	 01-0280	 01-0200
 01-0306	 01-0375	 01-0340
 01-2747	 01-0002	 01-0430
 01-0199	 01-0001	 01-0108
 01-0802	 01-0526	 01-0219
 01-0336	 01-0219	 01-0137
 01-0425	 01-0172	 01-3262
 01-WG01		
 01-0116		
 01-0268		
 01-0227		
 01-0151		
 ●● 8-0856		



umaBlackForest
Pens



Recycelte Variante
ULTIMATE SI RECY
Seite/page 67

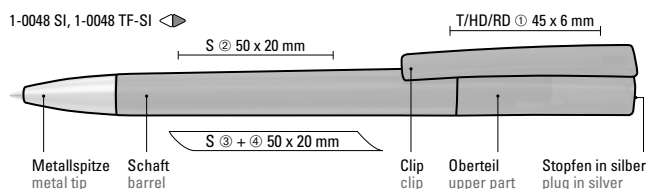

1-0048 SI: Drehkugelschreiber mit gedeckt mattem Gehäuse in weiß oder schwarz und Stopfen optional in verschiedenen matt gedeckten Farben oder silber erhältlich. Schwere Metallspitze matt verchromt.

1-0048 TF-SI: Drehkugelschreiber mit transparent gefrostetem Gehäuse und Stopfen optional in verschiedenen matt gedeckten Farben oder silber erhältlich. Schwere Metallspitze matt verchromt.

Mindestbestellmenge
Werbeschlüssel

1.000 Stück
Schaft S ○,
Clip T/HD/RD

1-0048 SI: Twist ballpoint pen with opaque matt housing in white or black and plug optionally available in various matt colours or silver. Heavy metal tip matt chromed.

1-0048 TF-SI: Twist ballpoint pen with transparent frosted housing and plug optionally available in various matt colours or silver. Heavy metal tip matt chromed.

Minimum quantity
Advertising code

1,000 pieces
barrel S ○,
clip T/HD/RD

PEPP SI
1-0145 SIPEPP transparent SI
1-0145 T-SIFarb-Code/Minen
Colour code/Refills

1-0145 SI (●● 8-0855)

01-0002



01-0001



●● 8-0855

1-0145 T-SI (●● 8-0856)

01-0306



01-2747



01-0199



01-0802



01-0336



01-0425



01-0003



01-0116



01-0268



01-0227



01-0151



●● 8-0856

umaBlackForest *Pens*

1-0145 SI: Druckkugelschreiber mit gedeckt glänzendem Gehäuse, Metallzierring, Drücker und schwere Metallspitze glanzverchromt.

1-0145 T-SI: Druckkugelschreiber mit transparent glänzendem Gehäuse, Metallzierring, Drücker und schwere Metallspitze glanzverchromt.

Mindestbestellmenge 1.000 Stück
Werbeschlüssel Schaft S ○, Clip T/HD/RD

1-0145 SI: Retractable ballpoint pen with opaque glossy housing, decorative metal ring, push-button and heavy metal tip chrome plated.

1-0145 T-SI: Retractable ballpoint pen with transparent housing, decorative metal ring, push-button and heavy metal tip chrome plated.

Minimum quantity 1,000 pieces
Advertising code barrel S ○, clip T/HD/RD

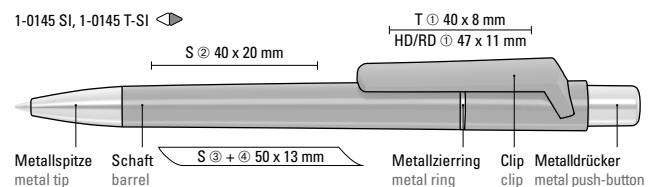

1-0044 SI (●● 8-0855)



1-0044 T-SI (●● 8-0856)



Stopfen/plug

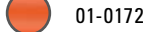
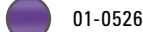
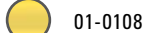
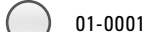
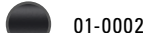
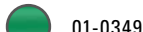
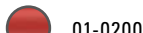
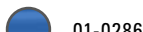

umaBlackForest
Pens

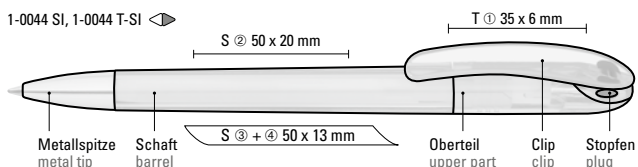

1-0044 SI: Drehkugelschreiber mit gedeckt glänzendem Gehäuse in schwarz oder weiß und farbigem Stopfen. Schwere Metallspitze glanzverchromt.

1-0044 T-SI: Drehkugelschreiber mit transparent glänzendem Gehäuse und farbigem Stopfen. Schwere Metallspitze glanzverchromt.

Mindestbestellmenge 1.000 Stück
Werbeschlüssel Schaft S ○, Clip T

1-0044 SI: Twist ballpoint pen with opaque glossy housing in black or white and coloured plug. Heavy metal tip chrome plated.

1-0044 T-SI: Twist ballpoint pen with transparent glossy housing and coloured plug. Heavy metal tip chrome plated.

Minimum quantity 1,000 pieces
Advertising code barrel S ○, clip T

CHIC SI
1-0149 SI

CHIC frozen SI
1-0149 TF-SI

Farb-Code/Minen
Colour code/Refills



1-0149 SI (●● 8-0855)

01-0002



01-0001



●● 8-0855

1-0149 TF-SI (●● 8-0856)

01-2747



01-0199



01-0336



01-0425



01-WG01



01-0116



01-0268



01-0227



01-0151



●● 8-0856

1-0149 SI: Drehkugelschreiber mit gedecktem mattem Gehäuse, schwere Metallspitze und Metallclip matt verchromt.

1-0149 TF-SI: Drehkugelschreiber mit transparent gefrostetem Gehäuse, schwere Metallspitze und Metallclip matt verchromt.

Mindestbestellmenge 1.000 Stück
Werbeschlüssel Schaft S O, Clip MT/L

1-0149 SI: Twist ballpoint pen with opaque matt housing, heavy metal tip and metal clip matt chrome plated.

1-0149 TF-SI: Twist ballpoint pen with transparent frosted housing, heavy metal tip and metal clip matt chrome plated.

Minimum quantity 1,000 pieces
Advertising code barrel S O, clip MT/L

umaBlackForest
Pens

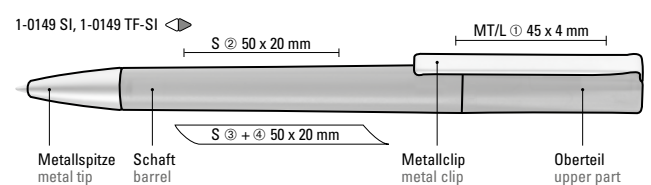

1-0041 SI (●●8-0855)



01-0002



01-0001



●●8-0855

1-0041 TF-SI (●●8-0856)



01-2747



01-0199



01-0336



01-0425



01-WG01



01-0116



01-0268



01-0227



01-0151



●●8-0856



Mit softem Drehmechanismus
With soft twist mechanism



umaBlackForest
Pens



POST-CONSUMER
RECYCLED PLASTIC

Recycelte Variante
CETA RECY
Seite/page 66

1-0041 SI, 1-0041 TF-SI

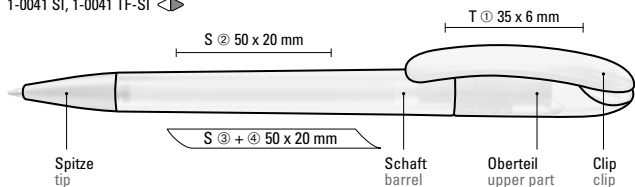

1-0041 SI: Drehkugelschreiber mit gedeckt mattem Gehäuse. Schwere matt verchromte Metallspitze.

1-0041 TF-SI: Drehkugelschreiber mit transparent gefrostetem Gehäuse. Schwere matt verchromte Metallspitze.

Mindestbestellmenge 1.000 Stück
Werbeschlüssel Schaft S O, Clip T

1-0041 SI: Twist ballpoint pen with opaque matt housing. Heavy metal tip matt chromed.

1-0041 TF-SI: Twist ballpoint pen with transparent frosted housing. Heavy metal tip matt chromed.

Minimum quantity 1,000 pieces
Advertising code barrel S O, clip T



1-0147 SI (● 8-0855)

1-0147 T-SI (● 8-0856)

01-0002 01-0306
01-0001 01-2747
01-0284 01-0199
01-0285 01-0802
01-0286 01-0336
01-1795 01-0425
01-0200 01-0003
01-0340 01-0116
01-0349 01-0227
01-0011 01-0268
01-0430 01-0151
01-0428
01-0127
01-0108
01-0513
01-0526
01-0262
01-0219
01-0714
01-0172
01-0332
01-3262

● 8-0855

● 8-0856

● 8-0855



umaBlackForest Pens

Stopfen 1 plug 1 Stopfen 2 plug 2

1-0147 SI, 1-0147 T-SI

S ② 50 x 20 mm T ① 40 x 6 mm

S ③ + ④ 50 x 20 mm T ⑤ 25 x 7 mm

Metallspitze metal tip Schaft barrel Clip clip Stopfen 1 plug 1

● 8-0855

Mix n' Match: Alle Teile können farblich frei kombiniert werden.

1-0147 SI: Drehkugelschreiber mit gedeckt glänzendem Gehäuse und Oberteil mit zwei farbigen Stopfen in gedeckt oder transparent. Schwere Metallspitze glanzverchromt.

1-0147 T-SI: Drehkugelschreiber mit transparent glänzendem Gehäuse und Oberteil mit zwei farbigen Stopfen in gedeckt oder transparent glänzend. Schwere Metallspitze glanzverchromt.

Mindestbestellmenge 1.000 Stück
Werbeschlüssel Schaft S ○, Clip T, Oberteil T































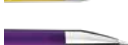



Mix n' Match: All parts can be colour-combined freely.

1-0147 SI: Twist ballpoint pen with opaque glossy housing and upper part with two coloured plug in opaque or transparent. Heavy metal tip chrome plated.

1-0147 T-SI: Twist ballpoint pen with transparent housing and upper part with two coloured plug in opaque or transparent. Heavy metal tip chrome plated.

Minimum quantity 1,000 pieces
Advertising code barrel S ○, clip T, upper part T



<p>1-0148 SI (●● 8-0855)</p>  01-0002  01-0001  ●● 8-0855	<p>1-0148 SI 1-0148 TF-SI Stopfen transparent/ plug transparent</p>  01-0306  01-2747  01-0199  01-0802  01-0336  01-2747  01-0199  01-0336  01-0425  01-WG01  01-0116  01-0268
<p>1-0148 TF-SI (●● 8-0856)</p>  01-2747  01-0199  01-0336  01-0425  01-WG01  01-0116  01-0268  01-0227  01-0151  ●● 8-0856	<p>Stopfen gedeckt/plug opaque</p>  01-0286  01-0200  01-0340  01-0002  01-0428  01-0001  01-0108  01-0526  01-0219  01-0172  01-3262



umaBlackForest
Pens

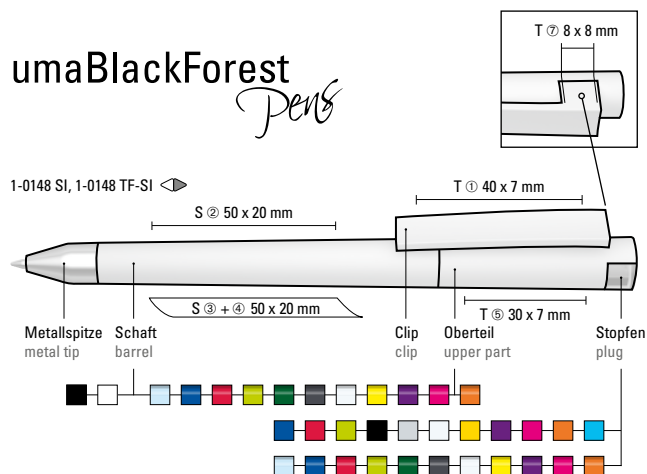

1-0148 SI: Drehkugelschreiber mit gedeckt mattem Gehäuse, Clip und Stopfen im Oberteil gedeckt glänzend bzw. transparent glänzend. Schwere Metallspitze glanzverchromt.

1-0148 TF-SI: Drehkugelschreiber mit gefrostetem Gehäuse, Clip und Stopfen im Oberteil gedeckt glänzend bzw. transparent glänzend. Schwere Metallspitze glanzverchromt.

Mindestbestellmenge 1.000 Stück
Werbeschlüssel Schaft S ⊕, Clip T, Oberteil T

1-0148 SI: Twist ballpoint pen with opaque matt housing and upper part with coloured plug in opaque or transparent. Heavy metal tip chrome plated.

1-0148 TF-SI: Twist ballpoint pen with transparent frosted housing and upper part with coloured plug in opaque or transparent. Heavy metal tip chrome plated.

Minimum quantity 1,000 pieces
Advertising code barrel S ⊕, clip T, upper part T



0-0531 (● 8-0866)	
	23-0002
	23-0001
	23-0280
	23-1795
	23-2250
	23-0011
	23-0430
	23-0102
	23-0268
	23-1665
0-0531 T (● 8-0866)	
	23-2935
	23-1795
	23-0355
	23-0404
	23-0003
	23-0102
	23-2613
	23-0021
	● 8-0866

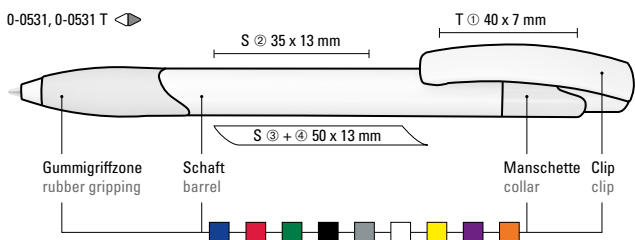

Mix n' Match: Ab 2.000 Stück kann das Modell farblich kombiniert werden.

0-0531: Druckkugelschreiber mit gedeckt glänzendem Schaft und Clipdrücker in weiß. Gummigriffzone und Manschette farbig.

0-0531 T: Druckkugelschreiber mit transparent glänzendem Schaft, Gummigriffzone und Clipdrücker.

Mindestbestellmenge 1.000 Stück
 Werbeschlüssel Schaft S ○, Clip T

Mix n' Match: From 2,000 pieces, you can choose any colour combination.

0-0531: Retractable ballpoint pen with opaque glossy barrel and clip push-button in white, rubber grip zone and collar coloured.

0-0531 T: Retractable ballpoint pen with transparent barrel, clip push-button and rubber grip zone.

Minimum quantity 1,000 pieces
 Advertising code barrel S ○, clip T



0-0112 SI (● 8-0877)

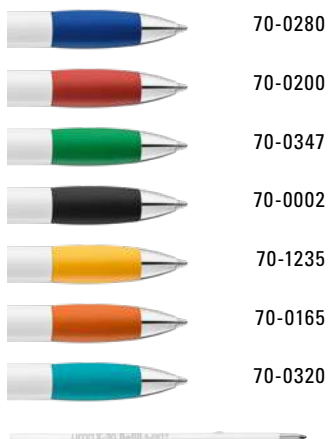

70-0280
70-0200
70-0347
70-0002
70-1235
70-0165
70-0320

● 8-0877

0-0112 T-SI (● 8-0866)



70-0288
70-0200
70-0355
70-3288
70-0430
70-0003
70-0388
70-0259
70-0214
70-0021
70-0313

● 8-0866



0-0112 SI, 0-0112 T-SI ◀

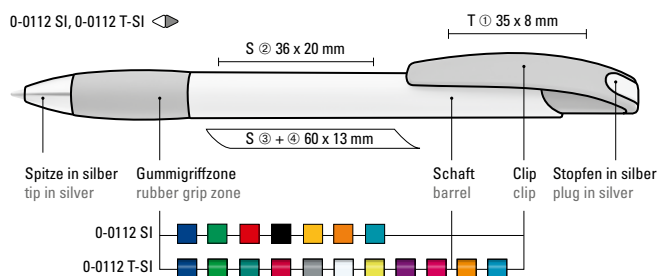

Mix n' Match: Ab 2.000 Stück kann das Modell farblich kombiniert werden.

0-0112 SI: Druckkugelschreiber mit gedeckt glänzendem Gehäuse in weiß, farbiger Gummigriffzone und Clipdrücker. Drückerstopfen und Spitze in silber glänzend.

0-0112 T-SI: Druckkugelschreiber mit transparent glänzendem Gehäuse, Gummigriffzone und Clipdrücker. Drückerstopfen und Spitze silber glänzend.

Mindestbestellmenge 1.000 Stück
Werbeschlüssel Schaft S ○, Clip T

Mix n' Match: From 2,000 pieces, you can choose any colour combination.

0-0112 SI: Retractable ballpoint pen with opaque glossy housing in white, coloured rubber grip zone and clip button. Plug and tip silver glossy.

0-0112 T-SI: Retractable ballpoint pen with transparent housing, rubber grip zone and clip button. Plug and tip silver glossy.

Minimum quantity 1,000 pieces
Advertising code barrel S ○, clip T





uma
VISUAL

Rundum schick – grenzenlos individuell! All-round stylish – infinitely individual!

uma VISUAL

Mit uma VISUAL wird das komplette Gehäuse eines Schreibgerätes zur beeindruckenden Werbefläche. Vielseitig und aufmerksamkeitsstark bietet sich so ganz viel Raum für die unterschiedlichsten Botschaften. Die Gestaltungsmöglichkeiten sind dabei nahezu grenzenlos – die Wirkung ist mehr als beeindruckend.



uma VISUAL

With uma VISUAL the entire barrel of a writing instrument becomes an impressive promotional surface. Versatile and visually striking, this area offers plenty of space for a vast range of messages. The design options here are almost unlimited – the impact is more than impressive.

uma VISUAL – der Kugelschreiber wird zur Werbefläche

Als „Die Handschrift der Werbung“ steht uma seit jeher für Innovation. Das gilt auch für unsere Veredelungsverfahren. Bei uma VISUAL wird durch digitale Folientransferdrucktechnik mit bis zu 1.200 dpi Auflösung das Gehäuse zahlreicher uma-Modelle zur faszinierenden Werbefläche. Vielseitig und aufmerksamkeitsstark bietet sich so Raum für die unterschiedlichsten Gestaltungsideen – rundum auffallend und individuell. Möglich ist praktisch alles, vom Logo oder Produktabbildungen bis zu individuellen Entwürfen und ganzen Bildwelten.

uma VISUAL – für Botschaften, die im Gedächtnis bleiben!

uma VISUAL – the ballpoint pen becomes an advertising space

Ever since its early days, uma has stood for innovation, with its motto of “Giving Advertisers a Signature Style”. This also applies to our surface enhancement procedures. With the uma VISUAL, digital film transfer printing technology with a resolution of up to 1200 dpi transforms the barrel of a great many uma models into a fascinating advertising space. The space for a vast array of design ideas can be used in a versatile and visually striking manner – with all-round eye-catching and individual appeal. Virtually anything is possible, from logo or product illustrations through to individual drafts and entire worlds of imagery.

uma VISUAL – for messages that remain in the memory!

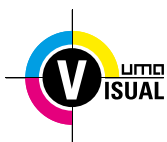



— Druckfläche/Print area size: ca. 109 x 38,5 mm —

FASHION SI VIS
0-0134 SI VIS
FASHION K transparent SI VIS
0-0134 KT-SI VIS
siehe Seite 149/see page 149



— Druckfläche/Print area size: ca. 109 x 38,5 mm —

VOGUE XL SI VIS
0-0136 SI VIS
siehe Seite 151/see page 151



— Druckfläche/Print area size: ca. 92,5 x 35 mm —

FANTASY VIS
0-0011 VIS
FANTASY transparent VIS
0-0011 T VIS
siehe Seite 152/see page 152



— Druckfläche/Print area size: ca. 92,5 x 35 mm —

SUNNY frozen VIS
0-0013 TF VIS
siehe Seite 152/see page 152



— Druckfläche/Print area size: ca. 92,5 x 35 mm —

ENERGY VIS
0-0012 VIS
ENERGY frozen VIS
0-0012 TF VIS
siehe Seite 153/see page 153





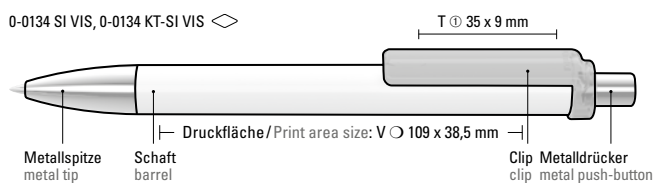
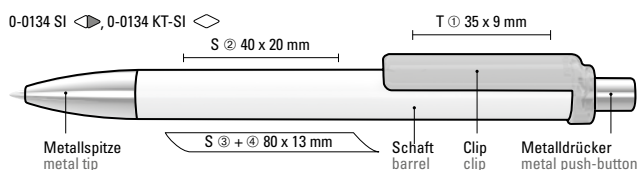
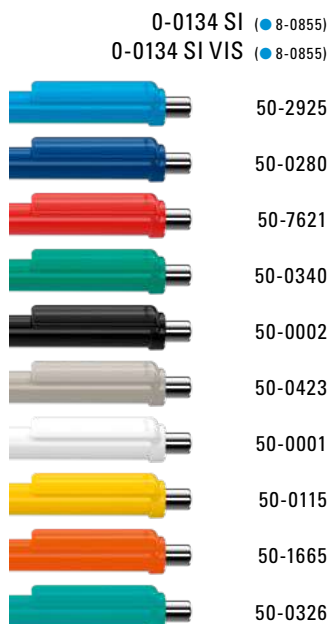

0-0134 SI: Druckkugelschreiber mit gedeckt glänzendem Schaft und Clip, Metallspitze und Metalldrücker glanzverchromt.

0-0134 SI VIS: Druckkugelschreiber FASHION SI mit digitalem Folientransferdruck auf dem Schaft.

0-0134 KT-SI: Druckkugelschreiber mit gedeckt glänzendem Schaft, transparent glänzendem Clip, Metallspitze und Metalldrücker glanzverchromt.

0-0134 KT-SI VIS: Druckkugelschreiber FASHION KT-SI mit digitalem Folientransferdruck auf dem Schaft.

0-0134 SI, 0-0134 KT-SI	1.000 Stück
Mindestbestellmenge	Schaft S ◯, Clip T
Werbeschlüssel	
0-0134 SI VIS, 0-0134 KT-SI VIS	1.000 Stück
Mindestbestellmenge	Schaft V, Clip T
Werbeschlüssel	

0-0134 SI: Retractable ballpoint pen with opaque glossy housing and clip, metal tip and metal push-button chrome plated.

0-0134 SI VIS: Retractable ballpoint pen FASHION SI with digital foil transfer imprint on the barrel.

0-0134 KT-SI: Retractable ballpoint pen with opaque glossy housing, transparent clip, metal tip and metal push-button chrome plated.

0-0134 KT-SI VIS: Retractable ballpoint pen FASHION KT-SI with digital foil transfer imprint on the barrel.

0-0134 SI, 0-0134 KT-SI	1,000 pieces
Minimum quantity	barrel S ◯, clip T
Advertising code	
0-0134 SI VIS, 0-0134 KT-SI VIS	1,000 pieces
Minimum quantity	barrel V, clip T
Advertising code	



0-0136 SI (● 8-0855)
0-0136 SI VIS (● 8-0855)

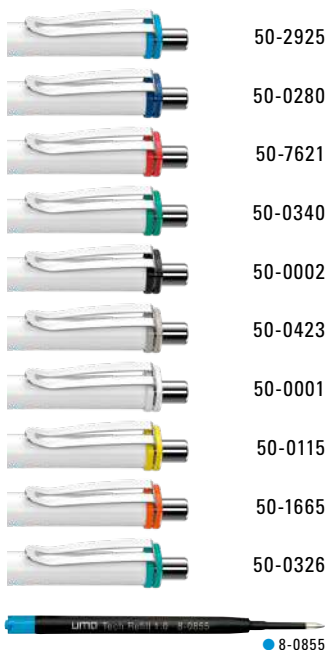

0-0136 SI ◀, 0-0136 SI VIS* ◊

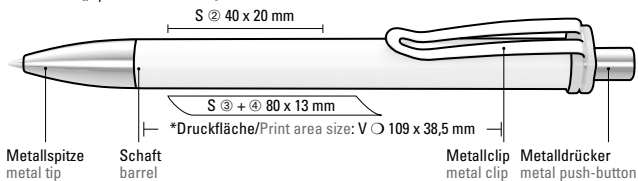

0-0136 SI: Druckkugelschreiber mit gedeckt glänzendem Schaft und Clipaufhängung. Breiter Metallbiegeclip, Metallspitze und Metalldrücker glanzverchromt.

0-0136 SI VIS: Druckkugelschreiber VOGUE XL SI mit digitalem Folientransferdruck auf dem Schaft.

0-0136 SI
Mindestbestellmenge
Werbeschlüssel

1.000 Stück
Schaft S ∅

0-0136 SI VIS
Mindestbestellmenge
Werbeschlüssel

1.000 Stück
Schaft V

0-0136 SI: Retractable ballpoint pen with opaque glossy housing and clip holder. Wide flexible metal clip, metal tip and metal push-button chrome plated.

0-0136 SI VIS: Retractable ballpoint pen VOGUE XL SI with digital foil transfer imprint on the barrel.

0-0136 SI
Minimum quantity
Advertising code

1,000 pieces
barrel S ∅

0-0136 SI VIS
Minimum quantity
Advertising code

1,000 pieces
barrel V

SUNNY frozen
0-0013 TF

FANTASY transparent
0-0011 T

FANTASY
0-0011

FANTASY VIS
0-0011 VIS

Farb-Code/Minen
Colour code/Refills



0-0013 TF (● 8-0866)
0-0011 T (● 8-0866)

- 70-0288
- 70-0200
- 70-0355
- 70-3288
- 70-0430
- 70-0003
- 70-0388
- 70-0259
- 70-0214
- 70-0021
- 70-0313



0-0011 (● 8-0877)

- 70-0280
- 70-0200
- 70-0347
- 70-0002
- 70-1235
- 70-0165
- 70-0320



Siehe weitere VIS-Modelle S. 146/147.
See other VIS models, p. 146/147.

Mix n' Match: Ab 2.000 Stück kann das Modell farblich kombiniert werden.

0-0013 TF: Druckkugelschreiber mit transparent gefrostetem Gehäuse, Gummigriffzone und Clipdrücker mit Stopfen.

0-0011 T: Druckkugelschreiber mit transparent glänzendem Gehäuse, Gummigriffzone und Clipdrücker. Stopfen silber metallic.

0-0011: Druckkugelschreiber mit gedeckt glänzendem Gehäuse und Clipdrücker in weiß, farbige Gummigriffzone und Stopfen.

Mindestbestellmenge 1.000 Stück
Werbeschlüssel Schaft S ○, Clip T

Mix n' Match: From 2,000 pieces, you can choose any colour combination.

0-0013 TF: Retractable ballpoint pen with transparent frosted housing, rubber grip zone and clip button with plug.

0-0011 T: Retractable ballpoint pen with transparent housing, rubber grip zone and clip button. Plug silver metallic.

0-0011: Retractable ballpoint pen with opaque glossy housing and clip button in white, coloured rubber grip zone and plug.

Minimum quantity 1,000 pieces
Advertising code barrel S ○, clip T

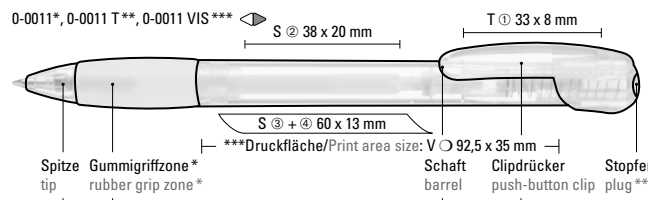
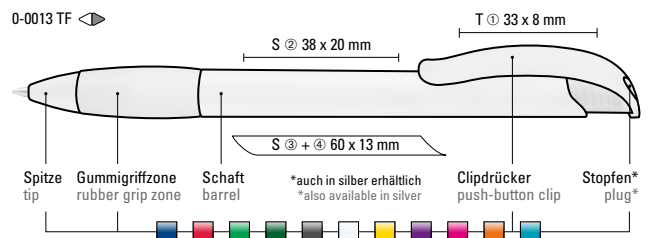

0-0011* * nicht in weiß erhältlich
0-0011 T* ** silber metallic
** silver metallic

0-0012 SI (● 8-0866)

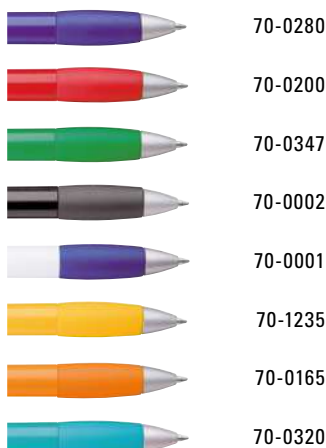

0-0012 TF-SI (● 8-0866)



● 8-0866



Siehe weitere VIS-Modelle S. 146/147.
See other VIS models, p. 146/147.

0-0012 SI*, 0-0012 TF-SI, 0-0012 VIS**

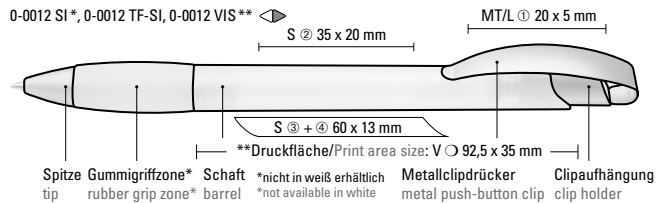

0-0012 SI*
0-0012 TF-SI



Mix n' Match: Ab 2.000 Stück kann das Modell farblich kombiniert werden.

0-0012 SI: Druckkugelschreiber mit gedeckt glänzendem Gehäuse, Gummigriffzone, matt verchromtem Metallclipdrücker und Spitze matt silber.

0-0012 TF-SI: Druckkugelschreiber mit transparent gefrostetem Gehäuse, Gummigriffzone, matt verchromtem Metallclipdrücker und Spitze matt silber.

Mindestbestellmenge 1.000 Stück
Werbeschlüssel Schaft S ○, Clip MT/L

Mix n' Match: From 2,000 pieces, you can choose any colour combination.

0-0012 SI: Retractable ballpoint pen with opaque glossy housing, rubber grip zone, metal clip button matt chrome plated and tip matt silver.

0-0012 TF-SI: Retractable ballpoint pen with transparent frosted housing, rubber grip zone, metal clip button matt chrome plated and tip matt silver.

Minimum quantity 1,000 pieces
Advertising code barrel S ○, clip MT/L



0-0119 GUM (● 8-0855)
0-0119 M GUM (● 8-0855)

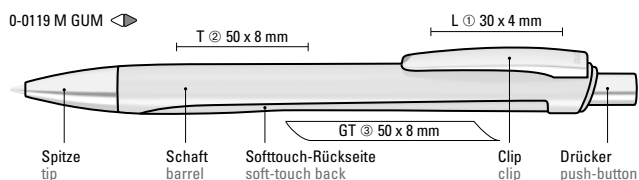
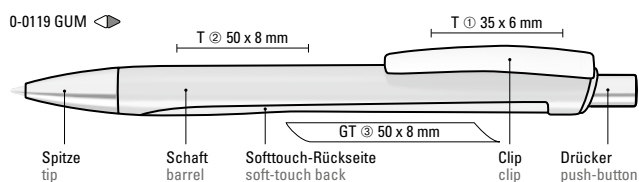
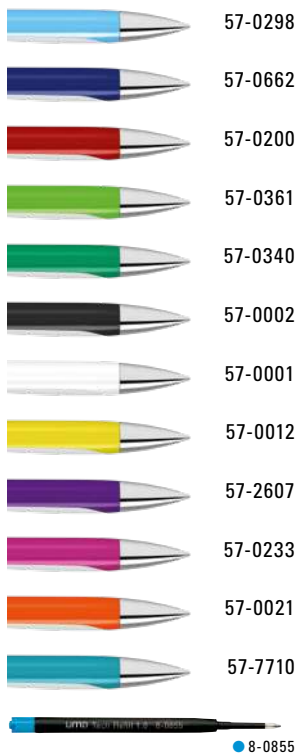

Mix n' Match: Ab 2.000 Stück kann das Modell farblich kombiniert werden.

0-0119 GUM: Druckkugelschreiber mit zweigeteiltem Schaft aus gedeckt glänzender Vorderseite und weiß gummierter Softtouch-Rückseite. Clip in gedeckt weiß. Spitze und Drücker silber glanzverchromt.

0-0119 M GUM: Druckkugelschreiber mit zweigeteiltem Schaft, aus gedeckt glänzender Vorderseite und farbig gummierter Softtouch-Rückseite. Metallclip, Spitze und Drücker silber glanzverchromt.

Mindestbestellmenge	1.000 Stück
Werbeschlüssel	Schaft T/GT, Clip T
Mindestbestellmenge	1.000 Stück
Werbeschlüssel	Schaft T/GT, Clip L

Mix n' Match: From 2,000 pieces, you can choose any colour combination.

0-0119 GUM: Retractable ballpoint pen with two-part barrel made from opaque glossy front and softtouch surface back in white. Clip in opaque white. Tip and push-button chrome plated.

0-0119 M GUM: Retractable ballpoint pen with two-part barrel made from opaque glossy front and coloured softtouch surface back. Metal clip, tip and push-button chrome plated.

Minimum quantity	1,000 pieces
Advertising code	barrel T/GT, clip T
Minimum quantity	1,000 pieces
Advertising code	barrel T/GT, clip L



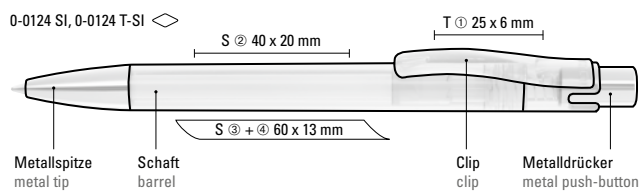
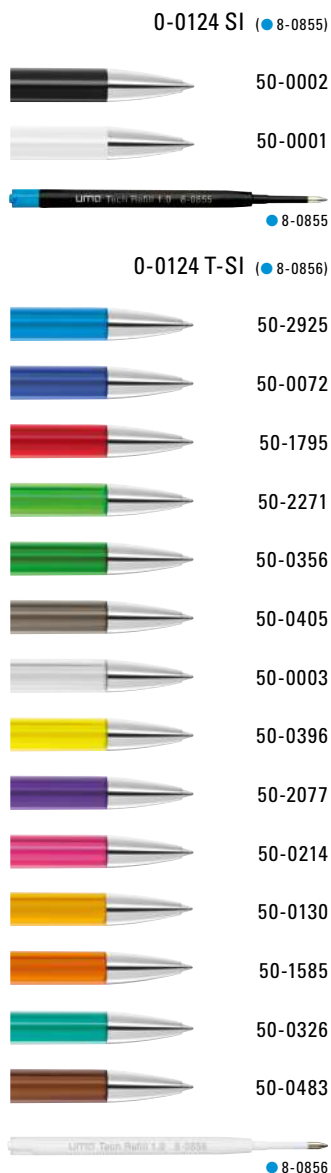

0-0124 SI: Druckkugelschreiber mit gedeckt glänzendem Gehäuse, Metalldrücker und schwerer Metallspitze glanzverchromt.

0-0124 T-SI: Druckkugelschreiber mit transparent glänzendem Gehäuse, Metalldrücker und schwerer Metallspitze glanzverchromt.





















Mindestbestellmenge 1.000 Stück
Werbeschlüssel Schaft S, Clip T

0-0124 SI: Retractable ballpoint pen with opaque glossy housing, heavy metal tip and metal push-button chrome plated.

0-0124 T-SI: Retractable ballpoint pen with transparent housing, heavy metal tip and metal push-button chrome plated.

Minimum quantity 1,000 pieces
Advertising code barrel S, clip T



- 0-0124 M-SI** (● 8-0855)
-  50-0002
 -  50-0001
 -  8-0855
- 0-0124 TM-SI** (● 8-0856)
-  50-2925
 -  50-0072
 -  50-1795
 -  50-2271
 -  50-0356
 -  50-0405
 -  50-0003
 -  50-0396
 -  50-0130
 -  50-2077
 -  50-0214
 -  50-1585
 -  50-0326
 -  50-0483
 -  8-0856
- 0-0124 LUX M-SI** (● 8-0855)
-  50-0004
 -  8-0855

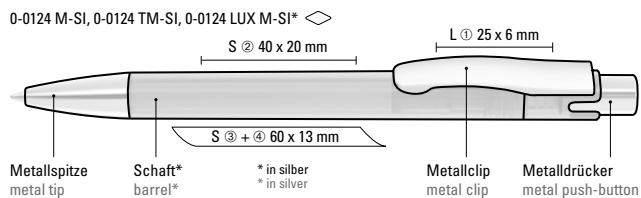

0-0124 M-SI: Druckkugelschreiber mit gedeckt glänzendem Gehäuse, schwerer Metallspitze, Metalldrücker und Metallclip glanzverchromt.

0-0124 TM-SI: Druckkugelschreiber mit transparent glänzendem Gehäuse, schwerer Metallspitze, Metalldrücker und Metallclip glanzverchromt.

0-0124 LUX M-SI: Druckkugelschreiber mit silber glänzendem Gehäuse, schwerer Metallspitze, Metalldrücker und Metallclip glanzverchromt.

Mindestbestellmenge 1.000 Stück
Werbeschlüssel Schaft S, Clip L

0-0124 M-SI: Retractable ballpoint pen with opaque glossy housing, heavy metal tip, metal push-button and metal clip chrome plated.

0-0124 TM-SI: Retractable ballpoint pen with transparent housing, heavy metal tip, metal push-button and metal clip chrome plated.

0-0124 LUX M-SI: Retractable ballpoint pen with opaque glossy housing in silver, heavy metal tip, metal push-button and metal clip chrome plated.

Minimum quantity 1,000 pieces
Advertising code barrel S, clip L

LOOK grip SI
0-0122 SI

LOOK grip transparent SI
0-0122 T-SI

Farb-Code/Minen
Colour code/Refills



0-0122 SI (● 8-0855)

50-0280

50-7621

50-0340

50-0011

50-0423

50-0002

8-0855

0-0122 T-SI (● 8-0856)

50-2925

50-0072

50-1795

50-2271

50-0356

50-0405

50-0003

50-0396

50-2077

50-0214

50-0130

50-1585

50-0326

50-0483

8-0856

0-0122 SI: Druckkugelschreiber mit gedeckt glänzendem Gehäuse, Gummigriffzone und schwerer Metallspitze glanzverchromt.

0-0122 T-SI: Druckkugelschreiber mit transparent glänzendem Gehäuse, Gummigriffzone und schwerer Metallspitze glanzverchromt.

Mindestbestellmenge 1.000 Stück
Werbeschlüssel Schaft S, Clip T

0-0122 SI: Retractable ballpoint pen with opaque glossy housing, rubber grip zone and heavy metal tip chrome plated.

0-0122 T-SI: Retractable ballpoint pen with transparent housing, rubber grip zone and heavy metal tip chrome plated.

Minimum quantity 1,000 pieces
Advertising code barrel S, clip T

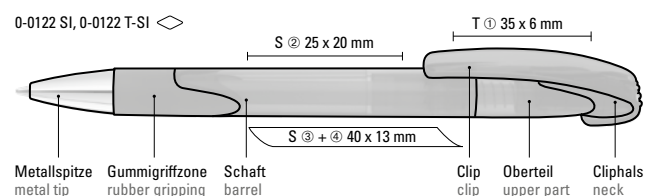

0-0122 M-SI (● 8-0855)

50-0002

50-0001

● 8-0855

0-0122 TM-SI (● 8-0856)

50-2925

50-0072

50-1795

50-2271

50-0356

50-0405

50-0003

50-0396

50-2077

50-0214

50-0130

50-1585

50-0326

50-0483

● 8-0856



0-0122 M-SI, 0-0122 TM-SI ◊

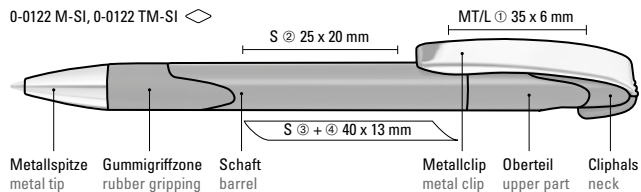

0-0122 M-SI: Druckkugelschreiber mit gedeckt glänzendem Gehäuse, Gummigriffzone, schwerer Metallspitze und Metallclip glanzverchromt.

0-0122 TM-SI: Druckkugelschreiber mit transparent glänzendem Gehäuse, Gummigriffzone, schwerer Metallspitze und Metallclip glanzverchromt.

Mindestbestellmenge 1.000 Stück
Werbeschlüssel Schaft S, Clip MT/L

0-0122 M-SI: Retractable ballpoint pen with opaque glossy housing, rubber grip zone, heavy metal tip and metal clip chrome plated.

0-0122 TM-SI: Retractable ballpoint pen with transparent housing, rubber grip zone, heavy metal tip and metal clip chrome plated.

Minimum quantity 1,000 pieces
Advertising code barrel S, clip MT/L



0-0015 (● 8-0855)
0-0015 D (● 8-0855)

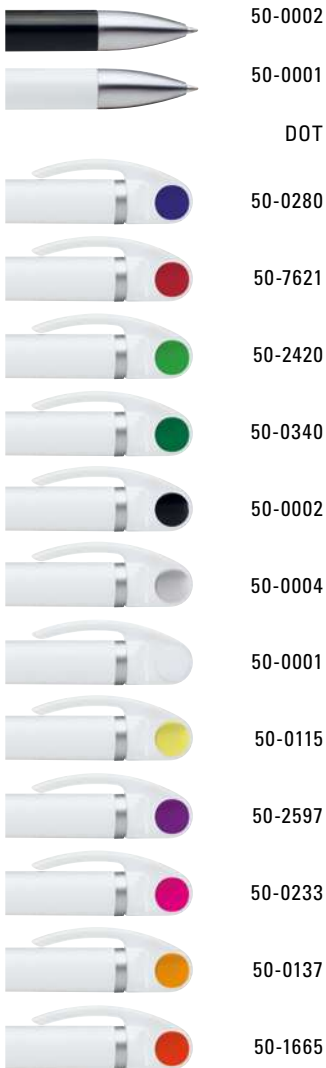

Mit bedruckbaren Dots!
With printable dots!

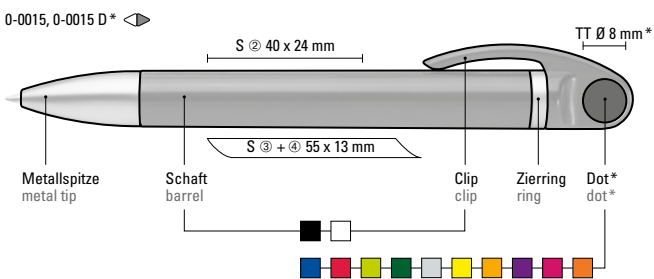

0-0015: Drehkugelschreiber mit gedeckt glänzendem Gehäuse in schwarz oder weiß, runde Aussparung, silber mattem Zierring und schwere Metallspitze matt verchromt.

0-0015 D: Drehkugelschreiber mit gedeckt glänzendem Gehäuse in schwarz oder weiß, farbig rundem DOT, silber mattem Zierring und schwere Metallspitze matt verchromt.

0-0015
Mindestbestellmenge 1.000 Stück
Werbeschlüssel Schaft S ○

0-0015 D
Mindestbestellmenge 1.000 Stück
Werbeschlüssel Schaft S ○, Stopfen T



















0-0015: Twist ballpoint pen with opaque glossy housing in black or white, round cutout, silver matt ring and heavy metal tip matt chrome plated.

0-0015 D: Twist ballpoint pen with opaque glossy housing in black or white, coloured round DOT, silver matt ring and heavy metal tip matt chrome plated.

0-0015
Minimum quantity 1,000 pieces
Advertising code barrel S ○

0-0015 D
Minimum quantity 1,000 pieces
Advertising code barrel S ○, plug T



- 0-0046 (● 8-0856)
-  50-0002
 -  50-0001
 -  50-2925
 -  50-0072
 -  50-1795
 -  50-2271
 -  50-0356
 -  50-0405
 -  50-0003
 -  50-0396
 -  50-2077
 -  50-0194
 -  50-0214
 -  50-0130
 -  50-1585
 -  50-0326
 -  50-0465
 -  50-0384
- 8-0856
- 0-0046 SI (● 8-0855)
-  50-0004
- 8-0855

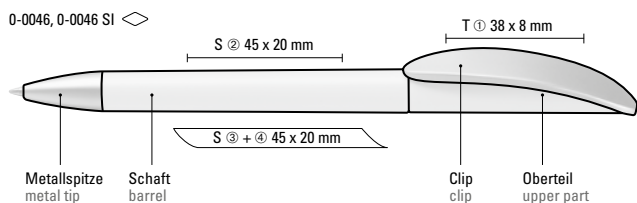

0-0046: Drehkugelschreiber mit transparent gefrostetem oder gedeckt mattem Gehäuse, Bogenclip silber matt und schwerer Metallspitze matt verchromt.

0-0046 SI: Drehkugelschreiber mit gedeckt silbernem Gehäuse, Bogenclip silber matt und schwerer Metallspitze matt verchromt.

Mindestbestellmenge 1.000 Stück
Werbeschlüssel Schaft S, Clip T

0-0046: Twist ballpoint pen with transparent frosted or opaque matt housing, curved clip silver matt and heavy metal tip matt chromed.

0-0046 SI: Twist ballpoint pen with opaque silver housing, curved clip silver matt and heavy metal tip matt chromed.

Minimum quantity 1,000 pieces
Advertising code barrel S, clip T



- 0-0146 SI (● 8-0855)**
-  50-0002
 -  50-0001
 -  ● 8-0855
- 0-0146 T-SI (● 8-0856)**
-  50-2925
 -  50-0072
 -  50-1795
 -  50-2271
 -  50-0356
 -  50-0405
 -  50-0003
 -  50-0396
 -  50-0214
 -  50-2077
 -  50-0130
 -  50-1585
 -  ● 8-0856

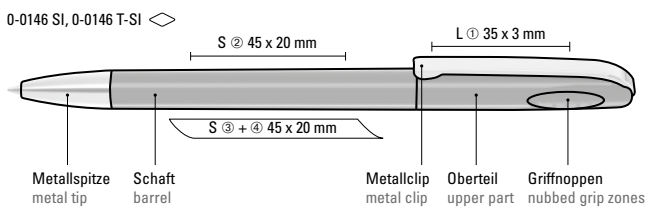

0-0146 SI: Drehkugelschreiber mit glänzend gedecktem Gehäuse, schwerer Metallspitze und Metallclip. Griffnoppen in der Kappe unterstützen den komfortablen Drehmechanismus.

0-0146 T-SI: Drehkugelschreiber mit glänzend transparentem Gehäuse, schwerer Metallspitze und Metallclip. Griffnoppen in der Kappe unterstützen den komfortablen Drehmechanismus.

Mindestbestellmenge 1.000 Stück
Werbeschlüssel Schaft S, Clip L

0-0146 SI: Twist ballpoint pen with opaque glossy housing, heavy metal tip and metal clip. A nubbed grip zone on the cap supports the comfortable twisting mechanism.

0-0146 T-SI: Twist ballpoint pen with transparent housing, heavy metal tip and metal clip. A nubbed grip zone on the cap supports the comfortable twisting mechanism.

Minimum quantity 1,000 pieces
Advertising code barrel S, clip L

JAZZ
0-0580

JAZZ frozen
0-0580 TF

Farb-Code/Minen
Colour code/Refills



0-0580 (● 8-0854)

50-0002



50-0001



0-0580 TF (● 8-0854)

50-0072



50-1795



50-2271



50-0356



50-0405



50-0396



50-2077



50-0214



50-1585



● 8-0854

0-0580: Druckkugelschreiber mit gedecktem Gehäuse, Gummigriffzone und geschwungenem Metallclip. Drücker, Zierring und Spitze in matt silber.

0-0580 TF: Druckkugelschreiber mit transparent gefrostetem Gehäuse, Gummigriffzone und geschwungenem Metallclip. Drücker, Zierring und Spitze in matt silber.

Mindestbestellmenge 1.000 Stück
Werbeschlüssel Schaft S

0-0580: Retractable ballpoint pen with opaque housing, rubber grip zone and curved metal clip. Push-button, ring and tip silver matt.

0-0580 TF: Retractable ballpoint pen with transparent frosted housing, rubber grip zone and curved metal clip. Push-button, ring and tip silver matt.

Minimum quantity 1,000 pieces
Advertising code barrel S

0-0580, 0-0580 TF ◊

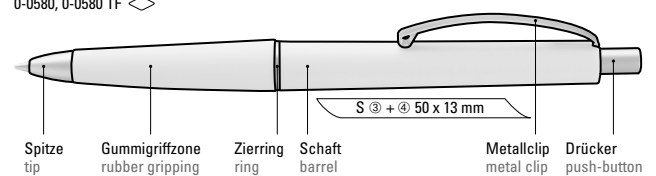

0-8600 (● 8-0856)
0-8607 B (0,7 mm)

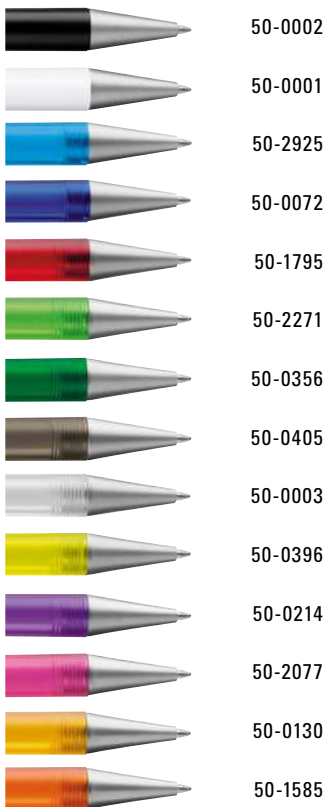

0-8600 GO (● 8-0855)



ETUI 0-0934
Beschreibung auf Seite 294
ETUI 0-0934
See description on page 294



0-8600: Druckkugelschreiber mit transparent gefrostetem oder gedecktem Gehäuse. Metalldrücker, Metallclip und Metallspitze matt verchromt.

0-8607 B: Druckbleistift (0,7mm) mit transparent gefrostetem oder gedecktem Gehäuse. Metalldrücker, Metallclip und Metallspitze matt verchromt.

0-8600 GO: Druckkugelschreiber mit schwarzem oder weißem Gehäuse. Metalldrücker, Metallclip und Metallspitze gold glänzend.

0-8600, 0-8607 B
Mindestbestellmenge 1.000 Stück
Werbeschlüssel Schaft S, Clip L

0-8600 GO
Mindestbestellmenge 1.000 Stück
Werbeschlüssel Schaft S, Clip L

0-8600: Retractable ballpoint pen with transparent frosted or opaque housing. Metal push-button, metal clip and metal tip matt chromed.

0-8607 B: Mechanical pencil (0.7mm) with transparent frosted or opaque housing. Metal push-button, metal clip and metal tip matt chromed.

0-8600 GO: Retractable ballpoint pen with opaque housing in black or white. Metal push-button, metal clip and metal tip gold-plated.

0-8600, 0-8607 B
Minimum quantity 1,000 pieces
Advertising code barrel S, clip L

0-8600 GO
Minimum quantity 1,000 pieces
Advertising code barrel S, clip L

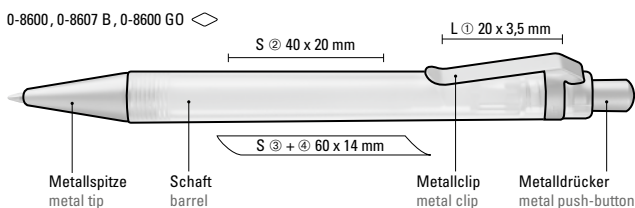

QUANTUM
0-0053

QUANTUM R
0-0053 R

QUANTUM PR
0-0053 PR

Farb-Code/Minen
Colour code/Refills



0-0053 (● 8-0855)
0-0053 R (● 8-0806)
0-0053 PR (● 8-0891)

52-0002



52-0001



● 8-0855



● ● 8-0806



● 8-0891

uma Patronen-Roller-System

Das uma Patronen-Roller-System ist die innovative Basis für neuartige Tintenroller-Schreibgeräte in Premium-Qualität. Dank seiner speziell entwickelten, verschleißarmen Kugelspitze punktet es mit einer bisher unerreichten Langlebigkeit und arbeitet nach dem Prinzip des Füllhalters und kann mit Standard-Tintenpatronen nachgefüllt werden. Die Schreibspitze mit TC-Kugel (0,7 mm) wird also immer wieder verwendet und nicht weggeworfen. So sind, mit dem uma Patronen-Roller-System ausgestattete Schreibgeräte nicht nur sehr wirtschaftlich, sondern auch in besonderem Maße umweltfreundlich.

uma cartridge roller system

The uma cartridge roller system is an innovative basis for novel rollerball writing instruments in premium quality. Thanks to its specifically developed wear-resistant ball tip, the uma cartridge roller system excels in an unrivalled longevity and operates on the same principle as the fountain pen and can be refilled with standard ink cartridges. Thus, the TC ball tip (0.7 mm) can be reused again and again and will not be disposed of. This makes these writing instruments not only extremely economical, but also very environmentally friendly.



Patronen-Roller-System/ uma cartridge roller system

0-0053: Drehkugelschreiber mit gedeckt glänzendem Gehäuse und Gummigriffzone in schwarz. Metallclip, Zierring und Metallspitze glanzverchromt.

0-0053 R: Rollerball mit gedeckt glänzendem Gehäuse. Metallclip und Zierring glanzverchromt.

0-0053 PR: Patronenroller mit gedeckt glänzendem Gehäuse. Metallclip und Zierring glanzverchromt. Das Patronen-Roller-System, ähnlich dem Prinzip des Füllhalters, ist mit Standard-Tintenpatronen wieder auffüllbar.

0-0053
Mindestbestellmenge 1.000 Stück
Werbeschlüssel Schaft S, Oberteil T

0-0053 R, 0-0053 PR
Mindestbestellmenge 1.000 Stück
Werbeschlüssel Schaft T, Kappe T

0-0053: Twist ballpoint pen with opaque glossy housing and rubber grip zone in black. Metal clip, decorative ring and tip chrome plated.

0-0053 R: Rollerball with opaque glossy housing. Metal clip and decorative ring chrome plated.

0-0053 PR: Cartridge roller system with opaque glossy housing. Metal clip and decorative ring chrome plated. The cartridge roller system operates on the same principle as the fountain pen and can be refilled with standard ink cartridges.

0-0053
Minimum quantity 1,000 pieces
Advertising code barrel S, upper part T

0-0053 R, 0-0053 PR
Minimum quantity 1,000 pieces
Advertising code barrel T, cap T

0-0053 ◊

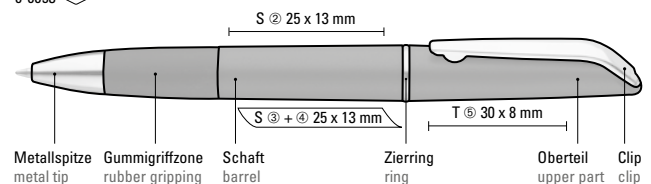

0-0053 R, 0-0053 PR ◊

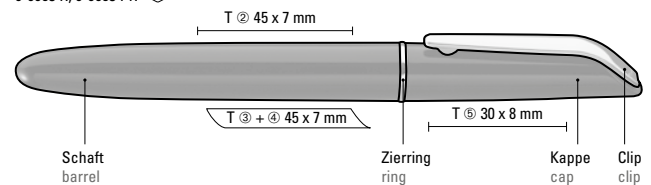

0-0053 M (● 8-0855)
0-0053 MR (● 8-0806)
0-0053 M PR (● 8-0891)



0-0053 M ◊

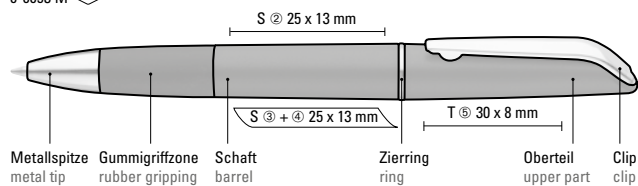

Metallspitze metal tip
Gummigriffzone rubber gripping
Schaft barrel
Zierring ring
Oberteil upper part
Clip clip

0-0053 MR, 0-0053 M-PR ◊

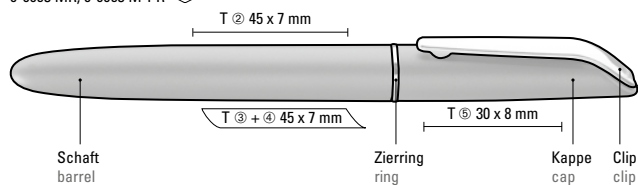

Schaft barrel
Zierring ring
Kappe cap
Clip clip

0-0053 M: Drehkugelschreiber mit Gehäuse im Metallicfarben, Gummigriffzone in schwarz. Metallclip, Zierring und Metallspitze glanzverchromt.

0-0053 MR: Rollerball mit Gehäuse in Metallicfarben. Metallclip und Zierring glanzverchromt.

0-0053 M PR: Patronenroller mit Gehäuse in Metallicfarben. Metallclip und Zierring glanzverchromt. Das Patronen-Roller-System, ähnlich dem Prinzip des Füllhalters, ist mit Standard-Tintenpatronen wieder auffüllbar.

0-0053 M	Mindestbestellmenge	1.000 Stück
Werbeschlüssel	Schaft S, Oberteil T	
0-0053 MR, 0-0053 M PR	Mindestbestellmenge	1.000 Stück
Werbeschlüssel	Schaft T, Kappe T	

0-0053 M: Twist ballpoint pen with housing in metallic colours and rubber grip zone in black. Metal clip, decorative ring and tip chrome plated.

0-0053 MR: Rollerball with housing in metallic colours. Metal clip and decorative ring chrome plated.

0-0053 M PR: Cartridge roller system with housing in metallic colours. Metal clip and decorative ring chrome plated. The cartridge roller system operates on the same principle as the fountain pen and can be refilled with standard ink cartridges.

0-0053 M	Minimum quantity	1,000 pieces
Advertising code	barrel S, upper part T	
0-0053 MR, 0-0053 MR	Minimum quantity	1,000 pieces
Advertising code	barrel T, cap T	



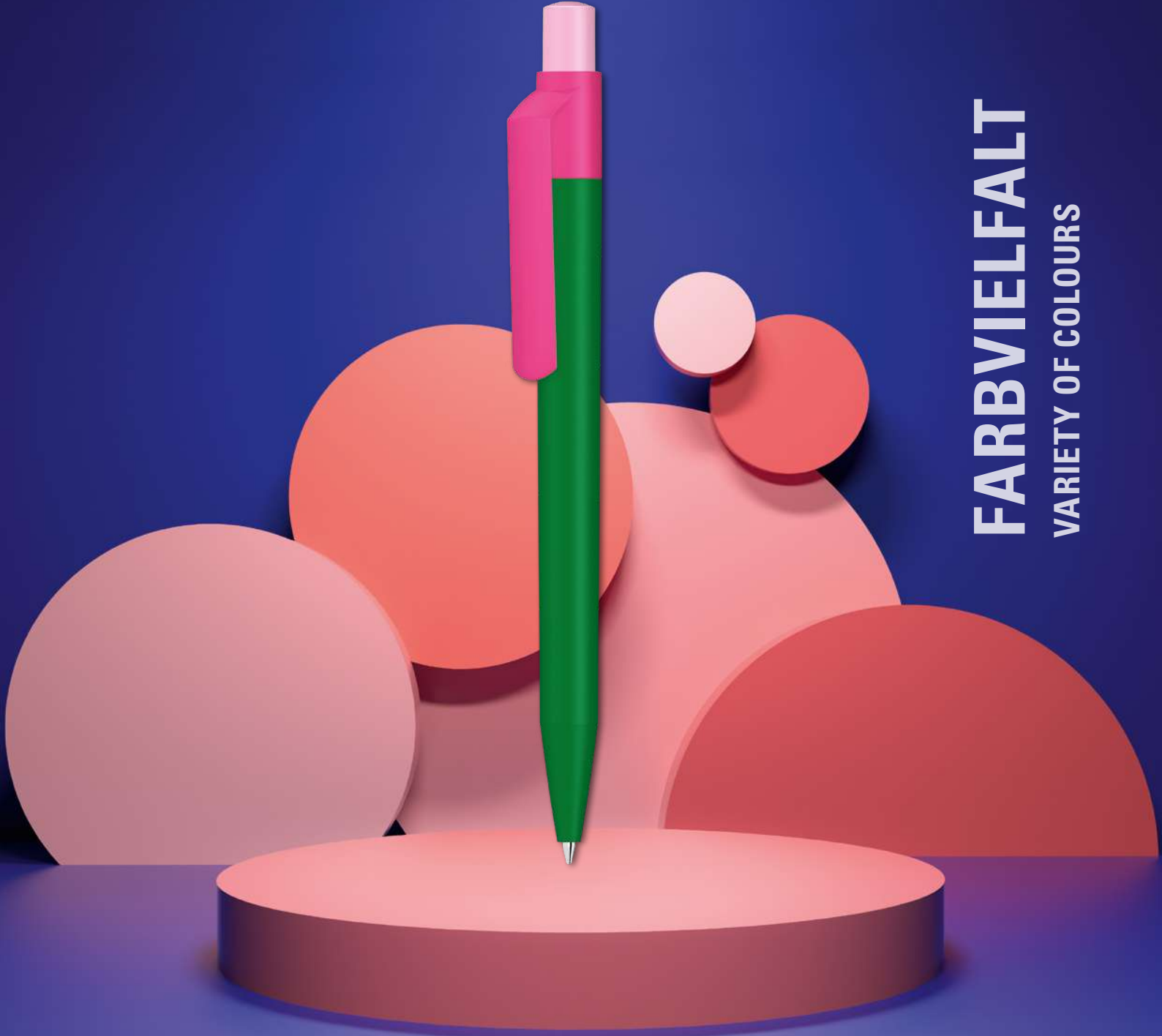

FARBVIELFALT
VARIETY OF COLOURS



DIE BUNTE WELT VON UMA

Wir bringen Farbe in die Welt der Schreibgeräte. Denn mit uma steht Ihnen nicht nur eine riesige Palette an unterschiedlichen Farben zur Verfügung, sondern auch beinahe unbegrenzte Möglichkeiten für bunte Kombinationen und Variationen.

THE COLOURFUL WORLD OF UMA

We bring colour into the world of writing instruments. You see, uma not only has a gigantic range of different colours at its disposal. It also offers almost unlimited scope for colourful combinations and variations.



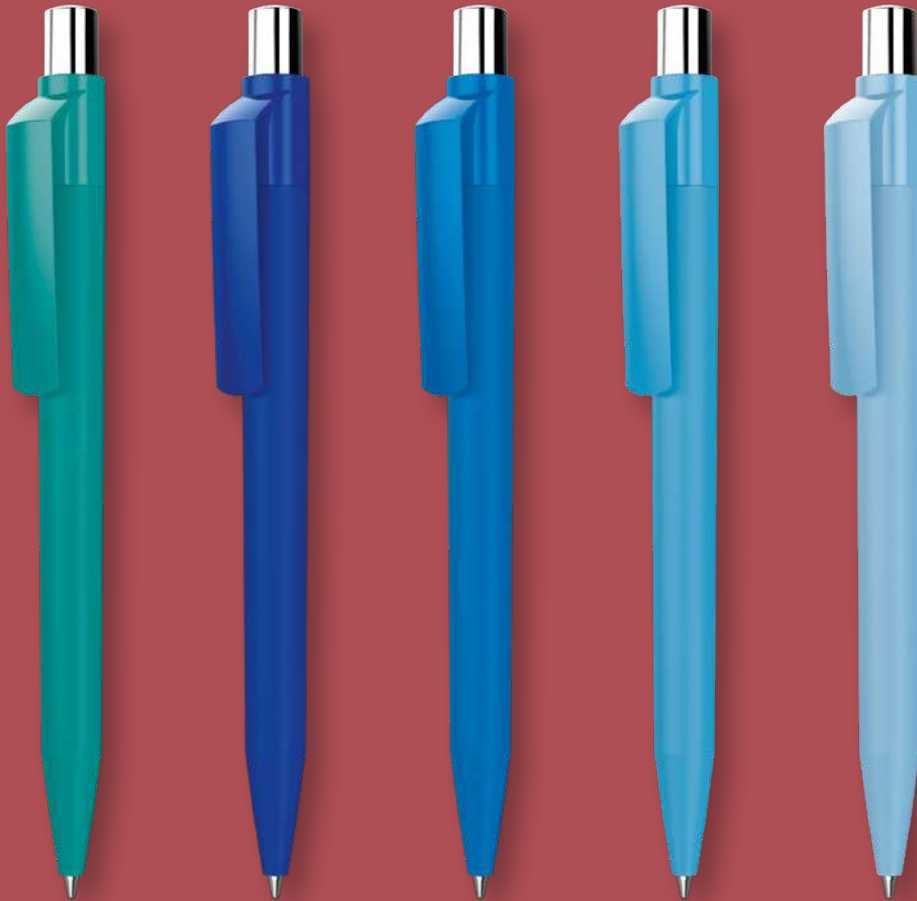

ON TOP
siehe Seite 176-179
see page 176-179





0-0063 F (● 8-0866)

-  32-0292
-  32-2175
-  32-2147
-  32-0200
-  32-0382
-  32-0348
-  32-0343
-  32-0002
-  32-0428
-  32-0001
-  32-0115
-  32-2705
-  32-2685
-  32-0188
-  32-0203
-  32-0213
-  32-1585
-  32-0638
-  32-3262
-  32-0321
-  32-0468
-  32-7569
-  32-0469



POST-CONSUMER
RECYCLED PLASTIC

Recycle Variante
ON TOP RECY
Seite/page 64



0-0063 F ◀

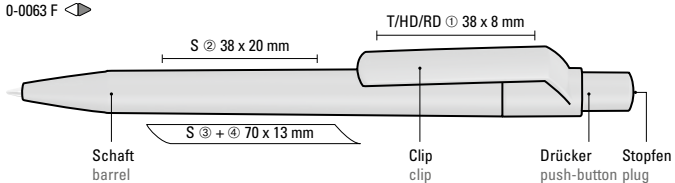

Mix n' Match: Ab 2.000 Stück kann das Modell farblich kombiniert werden.

0-0063 F: Druckkugelschreiber mit gedeckt mattem Gehäuse, Clip, Drücker und Stopfen.

Mindestbestellmenge
Werbeschlüssel

1.000 Stück
Schaft S ◯,
Clip T/HD/RD

Mix n' Match: From 2,000 pieces, you can choose any colour combination.

0-0063 F: Retractable ballpoint pen with opaque matt housing, clip, push-button and plug.

Minimum quantity
Advertising code

1,000 pieces
barrel S ◯,
clip T/HD/RD

ON TOP SI
0-0063 SI

ON TOP SI F
0-0063 SI F

Farb-Code/Minen
Colour code/Refills



POST-CONSUMER
RECYCLED PLASTIC

Recycelte Variante
ON TOP RECY
Seite/page 64



0-0063 SI (● 8-0866)

32-0001



0-0063 SI F (● 8-0866)

32-0292



32-2175



32-2147



32-0200



32-0382



32-0348



32-0343



32-0002



32-0428



32-0001



32-0115



32-2705



32-2685



32-0188



32-0203



32-0213



32-1585



32-0638



32-0321



32-0468



32-7569



32-0469



● 8-0866



Mix n' Match: Ab 2.000 Stück kann das Modell farblich kombiniert werden.

0-0063 SI: Druckkugelschreiber mit weiß gedeckt glänzendem Gehäuse, silber glänzendem Drücker und farbigem Stopfen.

0-0063 SI F: Druckkugelschreiber mit farbig gedeckt glänzendem Gehäuse, silber glänzendem Drücker und farbigem Stopfen.

Mindestbestellmenge 1.000 Stück
Werbeschlüssel Schaft S ○, Clip T/HD/RD

Mix n' Match: From 2,000 pieces, you can choose any colour combination.

0-0063 SI: Retractable ballpoint pen with opaque glossy housing in white, push-button silver glossy and coloured plug.

0-0063 SI F: Retractable ballpoint pen with opaque glossy coloured housing, push-button silver glossy and coloured plug.

Minimum quantity 1,000 pieces
Advertising code barrel S ○, clip T/HD/RD



0-0063 T-SI (● 8-0866)



0-0063 SI GUM
0-0063 KT-SI GUM*
(● 8-0866)



* Farben nicht für
0-0063 KT-SI GUM erhältlich
* Colours not available for
0-0063 KT-SI GUM



POST-CONSUMER
RECYCLED PLASTIC

Recycelte Variante
ON TOP RECY
Seite/page 64

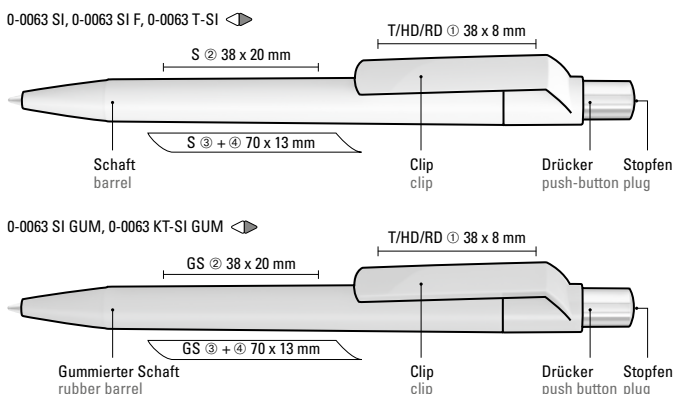

Mix n' Match: Ab 2.000 Stück kann das Modell farblich kombiniert werden.

0-0063 T-SI: Druckkugelschreiber mit transparent glänzendem Gehäuse, silber glänzendem Drücker und farbigem Stopfen.

0-0063 SI GUM: Druckkugelschreiber mit Softtouch-Schaft, gedeckt glänzendem Clip, silber glänzendem Drücker und farbigem Stopfen.

0-0063 KT-SI GUM: Druckkugelschreiber mit Softtouch-Schaft, transparent glänzendem Clip, silber glänzendem Drücker und farbigem Stopfen.

0-0063 T-SI
Mindestbestellmenge 1.000 Stück
Werbeschlüssel Schaft S ○, Clip T/HD/RD

0-0063 SI GUM, 0-0063 KT-SI GUM
Mindestbestellmenge 1.000 Stück
Werbeschlüssel Schaft GS, Clip T/HD/RD

Mix n' Match: From 2,000 pieces, you can choose any colour combination.

0-0063 T-SI: Retractable ballpoint pen with transparent housing, push-button silver glossy and coloured plug.

0-0063 SI GUM: Retractable ballpoint pen with softtouch housing, opaque glossy clip, push-button silver glossy and coloured plug.

0-0063 KT-SI GUM: Retractable ballpoint pen with softtouch housing, transparent clip, push-button silver glossy and coloured plug.

0-0063 T-SI
Minimum quantity 1,000 pieces
Advertising code barrel S ○, clip T/HD/RD

0-0063 SI GUM, 0-0063 KT-SI GUM
Minimum quantity 1,000 pieces
Advertising code barrel GS, clip T/HD/RD



0-0185 SI GUM (● 8-0866)

0-0183 F (● 8-0866)

	32-0292		32-0292
	32-2175		32-2175
	32-7686		32-2147
	32-1805		32-0200
	32-0382		32-0382
	32-0348		32-0348
	32-0343		32-0343
	32-0002		32-0002
	32-0428		32-0428
	32-0115		32-0001
	32-2705		32-0115
	32-2104		32-2705
	32-1817		32-2685
	32-0203		32-0188
	32-0213		32-0203
	32-1585		32-0213
	32-0638		32-1585
	32-3262		32-0638
	32-0321		32-3262
	32-0468		32-0321
	32-7569		32-0468
	32-0469		32-7569
	32-0469		32-0469



Wabenstruktur im Oberteil
Collar in honeycombed structure



POST-CONSUMER
RECYCLED PLASTIC

Recycelte Variante
VANE RECY
Seite/page 82

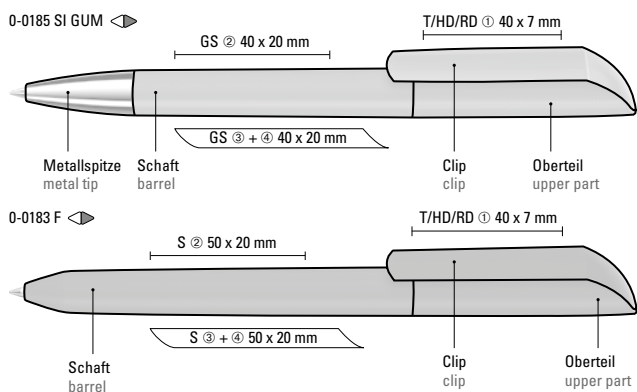

Mix n' Match: Ab 2.000 Stück kann das Modell farblich kombiniert werden.

0-0185 SI GUM: Drehkugelschreiber mit Softtouch-Gehäuse und gedeckt glänzendem Clip, Spitze glanzverchromt.

0-0183 F: Drehkugelschreiber mit gedeckt mattem Gehäuse und Clip.

0-0185 SI GUM
Mindestbestellmenge 1.000 Stück
Werbeschlüssel Schaft GS, Clip T/HD/RD

0-0183 F
Mindestbestellmenge 1.000 Stück
Werbeschlüssel Schaft S, Clip T/HD/RD

Mix n' Match: From 2,000 pieces, you can choose any colour combination.

0-0185 SI GUM: Twist ballpoint pen with softtouch housing and opaque glossy clip, tip chrome plated.

0-0183 F: Twist ballpoint pen with opaque matt housing and clip.

0-0185 SI GUM
Minimum quantity 1,000 pieces
Advertising code barrel GS, clip T/HD/RD

0-0183 F
Minimum quantity 1,000 pieces
Advertising code barrel S, clip T/HD/RD

VANE GUM NEON
0-0184 GUM NEON

VANE K transparent GUM
0-0184 KT GUM

Farb-Code/Minen
Colour code/Refills



0-0184 GUM NEON (● 8-0866)



0-0184 KT GUM (● 8-0866)



● 8-0866



POST-CONSUMER
RECYCLED PLASTIC

Recycelte Variante
VANE RECY
Seite/page 62

Mix n' Match: Ab 2.000 Stück kann das Modell farblich kombiniert werden.

0-0184 GUM NEON: Drehkugelschreiber mit Softtouch-Gehäuse und gedeckt glänzendem Clip in Neonfarben.

0-0184 KT GUM: Drehkugelschreiber mit Softtouch-Gehäuse und transparent glänzendem Clip.

Mindestbestellmenge
Werbeschlüssel

1.000 Stück
Schaft GS,
Clip T/HD/RD

Mix n' Match: From 2,000 pieces, you can choose any colour combination.

0-0184 GUM NEON: Twist ballpoint pen with softtouch housing and opaque glossy clip in neon-colours.

0-0184 KT GUM: Twist ballpoint pen with softtouch housing and transparent clip.

Minimum quantity
Advertising code

1,000 pieces
barrel GS,
clip T/HD/RD



0-0184 GUM NEON, 0-0184 KT GUM ◀

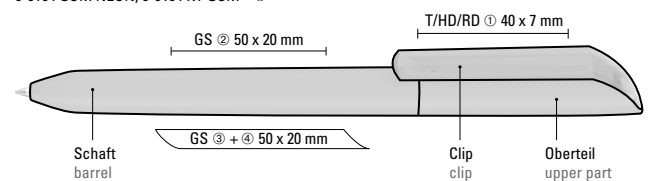

0-0184 GUM (● 8-0866)
0-0184 F GUM (● 8-0866)
0-0184 KG GUM (● 8-0866)



POST-CONSUMER
RECYCLED PLASTIC

Recycelte Variante
VANE RECY
Seite/page 62

0-0184 GUM: Mix n' Match:
Ab 2.000 Stück kann das Modell farblich kombiniert werden.

0-0184 GUM: Drehkugelschreiber mit Softtouch-Gehäuse und gedeckt glänzendem Clip.

0-0184 F GUM: Drehkugelschreiber mit Softtouch-Gehäuse in schwarz und gedeckt glänzendem farbigem Clip.

0-0184 KG GUM: Drehkugelschreiber mit Softtouch-Gehäuse und gedeckt glänzendem Clip in weiß.

Mindestbestellmenge
Werbeschlüssel

1.000 Stück
Schaft GS,
Clip T/HD/RD

0-0184 GUM: Mix n' Match:
From 2,000 pieces, you can choose any colour combination.

0-0184 GUM: Twist ballpoint pen with softtouch housing and opaque glossy clip.

0-0184 F GUM: Twist ballpoint pen with softtouch housing in black and opaque glossy coloured clip.

0-0184 KG GUM: Twist ballpoint pen with softtouch housing and opaque glossy clip in white.

Minimum quantity
Advertising code







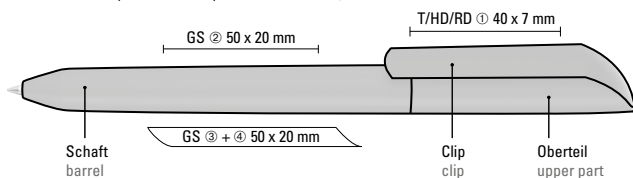















1,000 pieces
barrel GS,
clip T/HD/RD



0-0184 GUM ◀, 0-0184 F GUM, 0-0184 KG GUM ▶





0-0071 (● 8-0866)	0-0071 T (● 8-0866)
 32-0292	 32-0286
 32-2175	 32-0200
 32-2147	 32-0382
 32-0200	 32-2426
 32-0382	 32-0419
 32-0348	 32-0003
 32-0343	 32-0108
 32-0002	 32-0254
 32-0428	 32-2091
 32-0001	 32-0213
 32-0115	 32-1585
 32-2705	 32-0638
 32-2685	 32-3262
 32-0188	 32-7569
 32-0203	 32-0469
 32-0213	 ● 8-0866
 32-1585	
 32-0638	
 32-0321	
 32-0468	
 32-7569	
 32-0469	
 ● 8-0866	



POST-CONSUMER
RECYCLED PLASTIC

Recycelte Variante

POP RECY

Seite / page 63



0-0071, 0-0071 T ◀

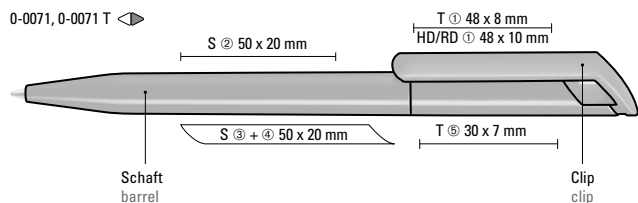

Mix n' Match: Ab 2.000 Stück kann das Modell farblich kombiniert werden.

0-0071: Drehkugelschreiber mit gedeckt glänzendem Gehäuse.

0-0071 T: Drehkugelschreiber mit transparent glänzendem Gehäuse.

Mindestbestellmenge 1.000 Stück
Werbeschlüssel Schaft S, Kappe T,
Clip T/HD/RD

Mix n' Match: From 2,000 pieces, you can choose any colour combination.

0-0071: Twist ballpoint pen with opaque glossy housing.

0-0071 T: Twist ballpoint pen with transparent housing.

Minimum quantity 1,000 pieces
Advertising code barrel S, cap T,
clip T/HD/RD

EFFECT SI
0-0086 SIEFFECT F-SI
0-0086 F-SIFarb-Code/Minen
Colour code/Refills0-0086 SI (● 8-0866)
0-0086 F-SI (● 8-0866)

32-0002



32-0001



32-0011



32-0292



32-2175



32-2147



32-0200



32-0382



32-0348



32-0343



32-0115



32-2705



32-2685



32-0188



32-0203



32-0213



32-1585



32-0321



32-0468



32-7569



32-0469



● 8-0866

Antibakterielle
Variante
EFFECT GREEN
Seite/page 51**Mix n' Match:** Ab 2.000 Stück kann das Modell farblich kombiniert werden.

0-0086 SI: Drehkugelschreiber mit gedeckt glänzendem Gehäuse in weiß, farbig glänzendem Stopfen und Spitze glanzverchromt.

0-0086 F-SI: Drehkugelschreiber mit gedeckt mattem Gehäuse in weiß, farbig glänzendem Stopfen und Spitze silber matt.

Mindestbestellmenge	1.000 Stück
Werbeschlüssel	Schaft S, Clip S/HD/RD, Stopfen TT

Mix n' Match: From 2,000 pieces, you can choose any colour combination.

0-0086 SI: Twist ballpoint pen with opaque glossy housing in white, coloured plug and tip chrome plated.

0-0086 F-SI: Twist ballpoint pen with opaque matt housing in white, coloured plug and tip silver matt.

Minimum quantity	1,000 pieces
Advertising code	barrel S, clip S/HD/RD, plug TT

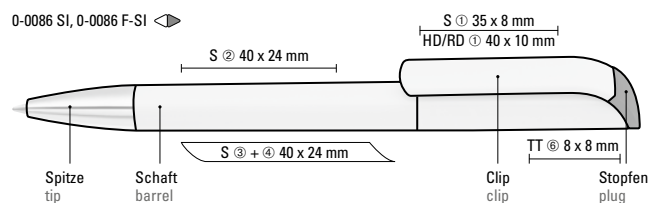

0-0086 TOP SI (● 8-0866)

0-0086 TOP T-SI (● 8-0866)



0-0086 TOP SI ◀▶ 0-0086 TOP T-SI ◀▶

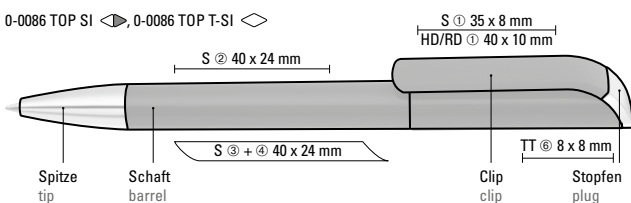

Mix n' Match: Ab 2.000 Stück kann das Modell farblich kombiniert werden.

0-0086 TOP SI: Drehkugelschreiber mit gedeckt glänzendem Gehäuse, Stopfen und Spitze glanzverchromt.

0-0086 TOP T-SI: Drehkugelschreiber mit transparent glänzendem Gehäuse, Stopfen und Spitze glanzverchromt.

Mindestbestellmenge 1.000 Stück
Werbeschlüssel Schaft S,
Clip S/HD/RD, Stopfen TT

Mix n' Match: From 2,000 pieces, you can choose any colour combination.





















0-0086 TOP SI: Twist ballpoint pen with opaque glossy housing, plug and tip chrome plated.

0-0086 TOP T-SI: Twist ballpoint pen with transparent housing, plug and tip chrome plated.

Minimum quantity 1,000 pieces
Advertising code barrel S,
clip S/HD/RD, plug TT

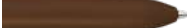

0-0057 GUM (● 8-0866)

	32-0292
	32-2175
	32-7686
	32-1805
	32-0382
	32-0348
	32-0343
	32-0002
	32-0428
	32-0115
	32-2705
	32-2104
	32-2104
	32-1817
	32-0203
	32-0213
	32-1585
	32-0638
	32-3262
	32-0321
	32-7569
	32-0469



POST-CONSUMER
RECYCLED PLASTIC

Recycelte Variante

ICONIC RECY

Seite/page 61

0-0057 GUM ◀▶

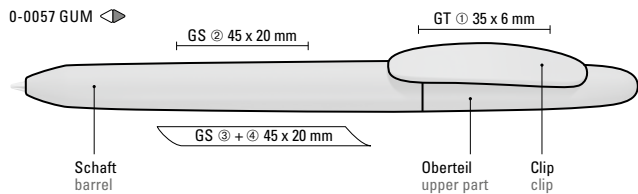

Mix n' Match: Ab 2.000 Stück kann das Modell farblich kombiniert werden.

0-0057 GUM: Drehkugelschreiber mit Softtouch-Gehäuse und Softtouch-Clip.

Mindestbestellmenge 1.000 Stück
Werbeschlüssel Schaft GS, Clip GT

Mix n' Match: From 2,000 pieces, you can choose any colour combination.

0-0057 GUM: Twist ballpoint pen with softtouch housing and softtouch clip.

Minimum quantity 1,000 pieces
Advertising code barrel GS, clip GT

ICON SI
0-0056 SI

ICON M SI
0-0056 M-SI

Farb-Code/Minen
Colour code/Refills

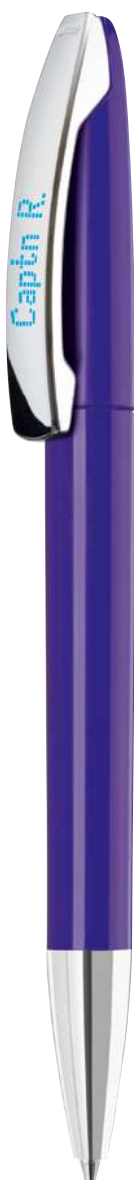

0-0056 SI (● 8-0866)
0-0056 M-SI (● 8-0866)

32-0292



32-2175



32-2147



32-0200



32-0382



32-0348



32-0343



32-0002



32-0001



32-0115



32-2705



32-2685



32-0188



32-0203



32-0213



32-1585



32-0321



32-0468



32-7569



32-0469



● 8-0866



Antibakterielle
Variante

ICON GREEN

Seite/page 51

Mix n' Match: Ab 2.000 Stück kann das Modell farblich kombiniert werden.

0-0056 SI: Drehkugelschreiber mit gedeckt glänzendem Gehäuse und Spitze glanzverchromt.

0-0056 M-SI: Drehkugelschreiber mit gedeckt glänzendem Gehäuse, Metallclip und Spitze glanzverchromt.

0-0056 SI
Mindestbestellmenge 1.000 Stück
Werbeschlüssel Schaft S, Clip T

0-0056 M-SI
Mindestbestellmenge 1.000 Stück
Werbeschlüssel Schaft S, Clip MT/L

Mix n' Match: From 2,000 pieces, you can choose any colour combination.

0-0056 SI: Twist ballpoint pen with opaque glossy housing and tip chrome plated.

0-0056 M-SI: Twist ballpoint pen with opaque glossy housing, metal clip and tip chrome plated.

0-0056 SI
Minimum quantity 1,000 pieces
Advertising code barrel S, clip T

0-0056 M-SI
Minimum quantity 1,000 pieces
Advertising code barrel S, clip MT/L

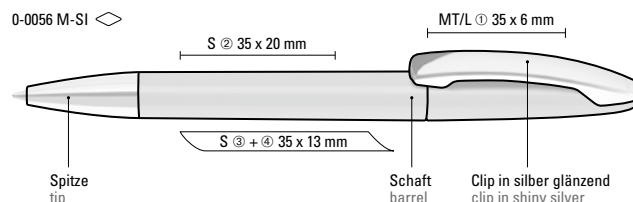
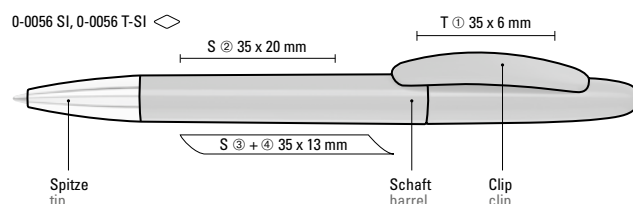

0-0056 T-SI (● 8-0866)
0-0056 TM-SI (● 8-0866)

0-0056 M-SI GUM (● 8-0866)

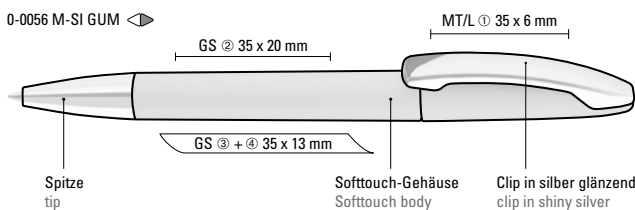
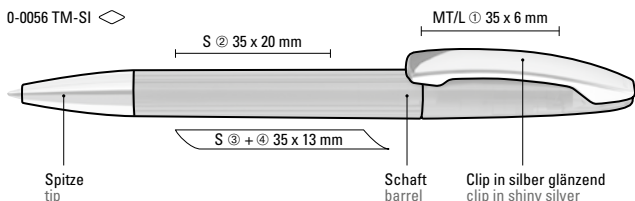

Mix n' Match: Ab 2.000 Stück kann das Modell farblich kombiniert werden.

0-0056 T-SI: Drehkugelschreiber mit transparent glänzendem Gehäuse und Spitze glanzverchromt.

0-0056 TM-SI: Drehkugelschreiber mit transparent glänzendem Gehäuse, Metallclip und Spitze glanzverchromt.

0-0056 M-SI GUM: Drehkugelschreiber mit Softtouch-Gehäuse, Metallclip und Spitze glanzverchromt.

0-0056 T-SI
Mindestbestellmenge 1.000 Stück
Werbeschlüssel Schaft S, Clip T

0-0056 TM-SI
Mindestbestellmenge 1.000 Stück
Werbeschlüssel Schaft S, Clip MT/L

0-0056 M-SI GUM
Mindestbestellmenge 1.000 Stück
Werbeschlüssel Schaft GS, Clip MT/L

Mix n' Match: From 2,000 pieces, you can choose any colour combination.

0-0056 T-SI: Twist ballpoint pen with transparent housing and tip chrome plated.

0-0056 TM-SI: Twist ballpoint pen with transparent housing, metal clip and tip chrome plated.

0-0056 M-SI GUM: Twist ballpoint pen with softtouch housing, metal clip and tip chrome plated.

0-0056 T-SI
Minimum quantity 1,000 pieces
Advertising code barrel S, clip T

0-0056 TM-SI
Minimum quantity 1,000 pieces
Advertising code barrel S, clip MT/L

0-0056 M-SI GUM
Minimum quantity 1,000 pieces
Advertising code barrel GS, clip MT/L



0-0017 (● 8-0866)

0-0017 KG F (● 8-0866)



0-0017 TF (● 8-0866)

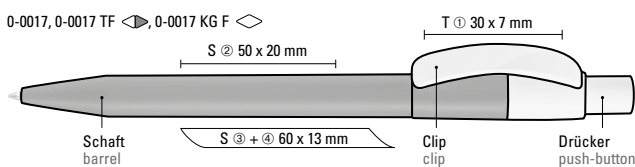

POST-CONSUMER
RECYCLED PLASTIC

Recycelte Variante
PIXEL RECY
Seite/page 65



Antibakterielle
Variante
PIXEL F GREEN
Seite/page 52

Mix n' Match: Ab 2.000 Stück kann das Modell farblich kombiniert werden.

0-0017: Druckkugelschreiber mit gedeckt glänzendem Gehäuse, Bogenclip und Drücker.

0-0017 TF: Druckkugelschreiber mit gefrostetem Gehäuse, glänzend transparentem Bogenclip und Drücker.

0-0017 KG F: Druckkugelschreiber mit farbig mattem Gehäuse, glänzend weißem Bogenclip und Drücker.

Mindestbestellmenge 1.000 Stück
Werbeschlüssel Schaft S ◊, Clip T

Mix n' Match: From 2,000 pieces, you can choose any colour combination.

0-0017: Retractable ballpoint pen with opaque glossy housing, curved clip and push-button.

0-0017 TF: Retractable ballpoint pen with transparent frosted housing, transparent glossy curved clip and push-button.

0-0017 KG F: Retractable ballpoint pen with opaque matt housing, opaque glossy curved clip and push-button in white.

Minimum quantity 1,000 pieces
Advertising code barrel S ◊, clip T



0-0045 (● 8-0866)

0-0045 SI (● 8-0866)

	32-2175		32-2175
	32-2147		32-2147
	32-0200		32-0200
	32-0348		32-0348
	32-0343		32-0343
	32-0002		32-0002
	32-0115		32-0001
	32-2617		32-0115
	32-0188		32-2617
	32-1585		32-0188
	32-0321		32-1585
	● 8-0866		32-0321
			32-0468
			● 8-0866

Kombinationsbeispiele
Examples of combinations

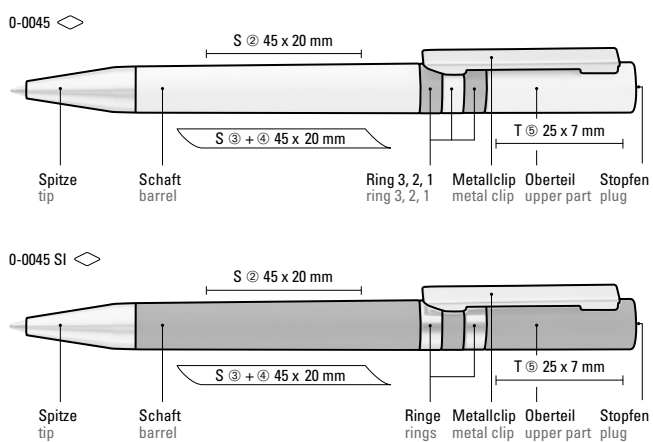

Mix n' Match: Ab 2.000 Stück kann das Modell farblich kombiniert werden.

0-0045: Drehkugelschreiber mit gedeckt glänzendem Gehäuse in weiß, farbig eingelassene Ringe und Stopfen im Oberteil. Metallclip und Spitze in silber glänzend.

0-0045 SI: Drehkugelschreiber mit gedeckt glänzendem Gehäuse. Eingelassene Ringe, Stopfen im Oberteil, Metallclip und Spitze in silber glänzend.

Mindestbestellmenge 1.000 Stück
Werbeschlüssel Schaft S, Kappe T

Mix n' Match: From 2,000 pieces, you can choose any colour combination.

0-0045: Twist ballpoint pen with opaque glossy housing in white, coloured rings and plug. Metal clip and tip silver glossy.

0-0045 SI: Twist ballpoint pen with opaque glossy housing. Rings, plug, metal clip and tip silver glossy.

Minimum quantity 1,000 pieces
Advertising code barrel S, cap T





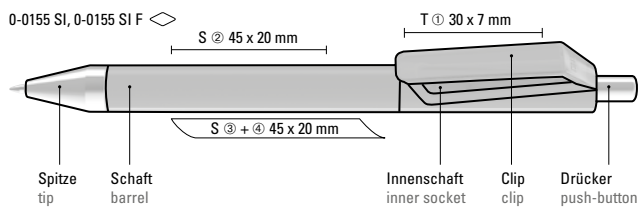
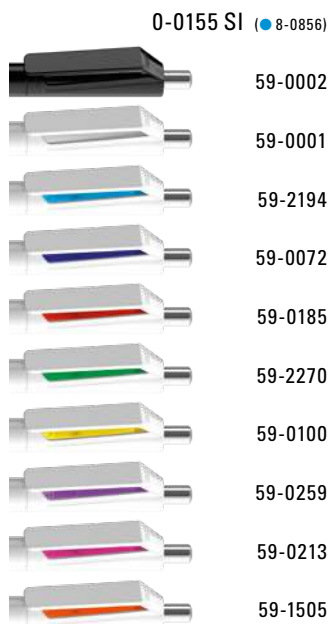

0-0155 SI: Druckkugelschreiber mit gedeckt glänzendem Gehäuse in weiß oder uni schwarz, farbig transparent glänzendem Innenschaft. Spitze und Dräcker in silber glänzend.

0-0155 SI F: Druckkugelschreiber mit gedeckt glänzendem Gehäuse, transparent glänzendem Innenschaft und Clip. Spitze und Dräcker in silber glänzend.

Mindestbestellmenge 1.000 Stäck
Werbeschlässel Schaft S, Clip T

0-0155 SI: Retractable ballpoint pen with opaque glossy housing in white or uni black, coloured transparent inner part. Tip and push-button silver glossy.

0-0155 SI F: Retractable ballpoint pen with opaque glossy housing, coloured transparent inner part and clip. Tip and push-button silver glossy.

Minimum quantity 1,000 pieces
Advertising code barrel S, clip T



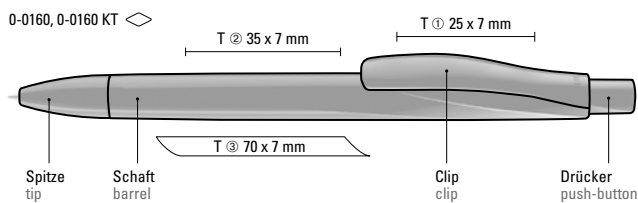

0-0160: Druckkugelschreiber mit geometrisch wechselnder Schaftform und gedeckt glänzendem Gehäuse.

0-0160 KT: Druckkugelschreiber mit geometrisch wechselnder Schaftform und gedeckt glänzendem Gehäuse, Clip und Drücker transparent glänzend.

Mindestbestellmenge 1.000 Stück
Werbeschlüssel Schaft T, Clip T

0-0160: Retractable ballpoint pen with geometric changes in the barrel and opaque glossy housing.

0-0160 KT: Retractable ballpoint pen with geometric changes in the barrel and opaque glossy housing, clip and push-button transparent.

Minimum quantity 1,000 pieces
Advertising code barrel T, clip T



Farb-Code/Minen
Colour code/Refills

SPLASH SI
0-0058 SI

SPLASH transparent SI
0-0058 T-SI

STRIPE
0-0039

201

0-0058 SI (● 8-0854)



0-0058 T-SI (● 8-0854)



0-0039 (● 8-0875)

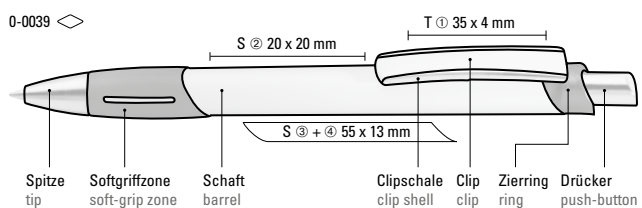
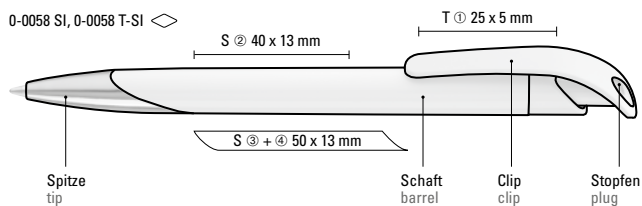

0-0058 SI: Druckkugelschreiber mit glänzend gedecktem Gehäuse, Spitze und Clipstopfen silber glänzend.

0-0058 T-SI: Druckkugelschreiber mit glänzend transparentem Gehäuse, Spitze und Clipstopfen silber glänzend.

0-0039: Druckkugelschreiber mit gedeckt weißem Gehäuse, Spitze und Clipstopfen silber glänzend, Zierring und Clipschale.

Mindestbestellmenge 1.000 Stück
Werbeschlüssel Schaft S, Clip T

0-0058 SI: Retractable ballpoint pen with opaque glossy housing, tip and clip plug silver glossy.

0-0058 T-SI: Retractable ballpoint pen with transparent housing, tip and clip plug silver glossy.

0-0039: Retractable ballpoint pen with opaque housing in white, transparent frosted rubber grip zone, decorative ring and clip shell.

Minimum quantity 1,000 pieces
Advertising code barrel S, clip T

VIANI
1-0735

TORSION
1-0690

SPIRIT transparent
1-0765 T

Farb-Code/Minen
Colour code/Refills



1-0735 (●●8-0877)
1-0690 (●●8-0855)

- 01-0286
- 01-0200
- 01-0340
- 01-0002
- 01-0428
- 01-0001
- 01-0108
- 01-0219
- 01-0172
- 01-3262



1-0765 T (●●8-0866)

- 01-2747
- 01-0199
- 01-0336
- 01-0425
- 01-0003
- 01-0116
- 01-0227
- 01-0151



Mix n' Match: Alle Teile können farblich frei kombiniert werden.

1-0735: Druckkugelschreiber mit gedeckt glänzendem Gehäuse und großem Clip an genoppter Clipaufhängung.

1-0690: Druckkugelschreiber mit gedeckt glänzendem Gehäuse, vernickeltem Metallbiegeclip und Metallspitze.

1-0765 T: Druckkugelschreiber mit transparent gefrostetem Gehäuse und großem Clip an genoppter Clipaufhängung.

1-0735, 1-0765 T
Mindestbestellmenge 1.000 Stück
Werbeschlüssel Schaft S ○, Clip S

1-0690
Mindestbestellmenge 1.000 Stück
Werbeschlüssel Schaft S ○

Mix n' Match: All parts can be colour-combined freely.

1-0735: Retractable ballpoint pen with opaque glossy housing and large clip on nubbed clip holder.

1-0690: Retractable ballpoint pen with opaque glossy housing, nickel-plated flexible metal clip and metal tip silver glossy.

1-0765 T: Retractable ballpoint pen with transparent frosted housing and large clip on nubbed clip holder.

1-0735, 1-0765 T
Minimum quantity 1,000 pieces
Advertising code barrel S ○, clip S

1-0690
Minimum quantity 1,000 pieces
Advertising code barrel S ○

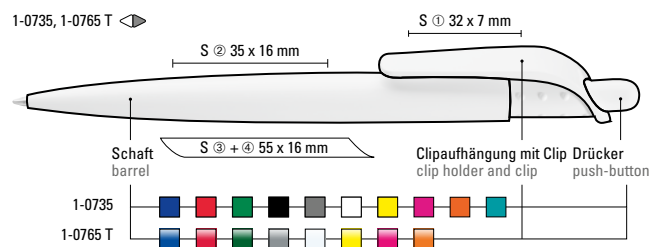
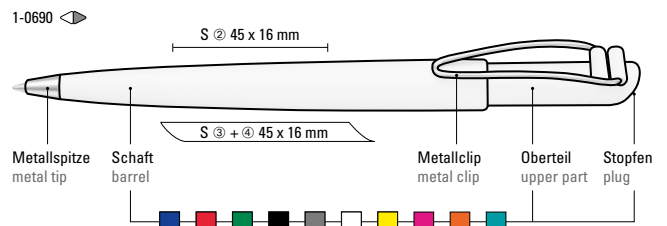

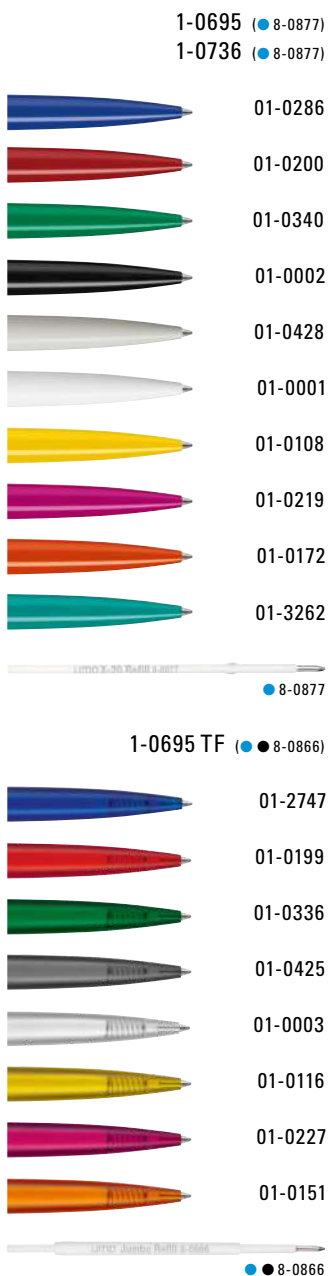

Recyclete
Variante
VITAN RECY
Seite/page 55

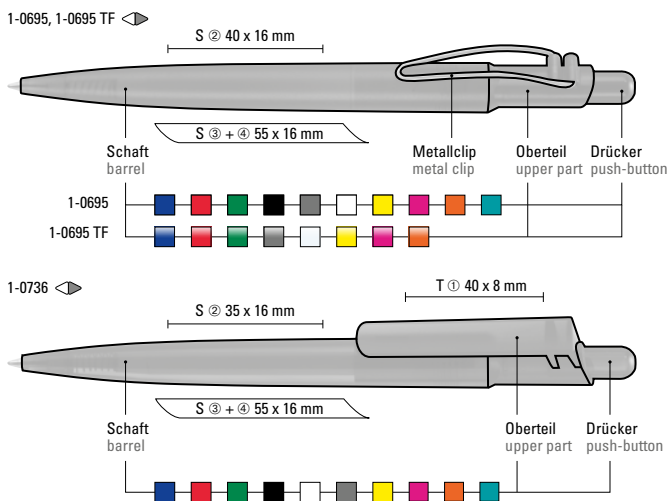

Mix n' Match: Alle Teile können farblich frei kombiniert werden.

1-0695: Druckkugelschreiber mit gedeckt glänzendem Gehäuse und vernickeltem Metallbiegeclip.

1-0695 TF: Druckkugelschreiber mit transparent gefrostetem Gehäuse und vernickeltem Metallbiegeclip.

1-0736: Druckkugelschreiber mit gedeckt glänzendem Gehäuse und großem Clip an verstärkter Clipanbindung.

Mix n' Match: All parts can be colour-combined freely.

1-0695: Retractable ballpoint pen with opaque glossy housing and nickel-plated flexible metal clip.

1-0695 TF: Retractable ballpoint pen with transparent frosted housing and nickel-plated flexible metal clip.

1-0736: Retractable ballpoint pen with opaque glossy housing and large clip.

1-0695, 1-0695 TF
Mindestbestellmenge
Werbeschlüssel
1.000 Stück
Schaft S ○

1-0736
Mindestbestellmenge
Werbeschlüssel
1.000 Stück
Schaft S ○, Clip T

1-0695, 1-0695 TF
Minimum quantity
Advertising code
1,000 pieces
barrel S ○

1-0736
Minimum quantity
Advertising code
1,000 pieces
barrel S ○, clip T

FLEXI
6-2860 G

FLEXI M
6-2861 G

PREMIUM
6-3000

PREMIUM S
6-3100

Farb-Code/Minen
Colour code/Refills



- 6-2860 G ●● 8-0866
- 6-2861 G ●● 8-0866
- 6-3000 ●● 8-0855
- 6-3100 ●● 8-0855

- 06-2925
- 06-0294
- 06-0281
- 06-1795
- 06-0349
- 06-0002
- 06-0424
- 06-0001
- 06-0012
- 06-2655
- 06-0219
- 06-1665
- 06-0329
- LITKO "LITKO" "LITKO" "LITKO" "LITKO" "LITKO" ●● 8-0866
- LITKO "LITKO" "LITKO" "LITKO" "LITKO" "LITKO" ●● 8-0855

Mix n' Match: Alle Teile können farblich frei kombiniert werden.

6-2860 G: Druckkugelschreiber mit gedecktem Gehäuse und flexiblem und vernickeltem Metallfederclip.

6-2861 G: Druckkugelschreiber wie 6-2860 G, jedoch mit Metallmanschette als Griffzone.

6-3000: Druckkugelschreiber mit beweglichem Drückerkopf und vernickelter Metallfeder. Vernickelter Metallnadelclip und Zierring.

6-3100: Druckkugelschreiber mit beweglichem Drückerkopf auf vernickelter Metallfeder. Vernickelter Metallnadelclip und schwere Metallspitze.

Mindestbestellmenge
Werbeschlüssel

1.000 Stück
Schaft S ○

Mix n' Match: All parts can be colour-combined freely.

6-2860 G: Retractable ballpoint pen with flexible, nickel-plated springy metal clip.

6-2861 G: Retractable ballpoint pen like 6-2860 G, but with metal-collar grip zone.









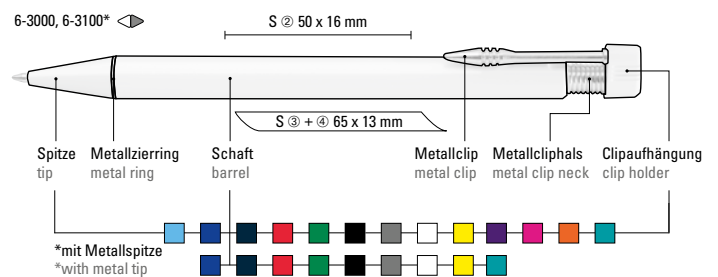
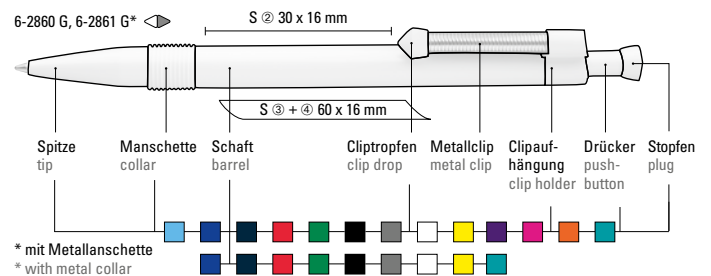













6-3000: Retractable ballpoint pen with mobile push-button and nickel-plated metal spring. Metal clip and decorative ring nickel-plated.

6-3100: Retractable ballpoint pen with mobile push-button on nickel-plated metal spring. Nickel-plated metal clip and heavy metal tip.

Minimum quantity
Advertising code

1,000 pieces
barrel S ○



6-3500* (●● 8-0866)	
6-3510* (●● 8-0866)	
	06-0294
	06-0281
	06-1795
	06-0349
	06-0002
	06-0424
	06-0001
	06-0012
	06-0329
6-3500 TF (●● 8-0866)	
6-3510 TF (●● 8-0866)	
	06-0306
	06-0294
	06-0281
	06-0200
	06-0355
	06-0425
	06-0003
	06-0102
	06-0137
	06-0272
	06-0213
	06-0172
	
●● 8-0866	



* Clipdrücker und Gummigriffzone bei 6-3500 und 6-3510 auch in hellblau erhältlich.

* Clip push-button and rubber gripping 6-3500 and 6-3510 also available in light blue.

6-3500, 6-3500 TF ◀

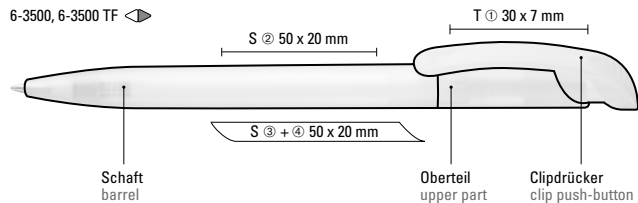

6-3510, 6-3510 TF ◀

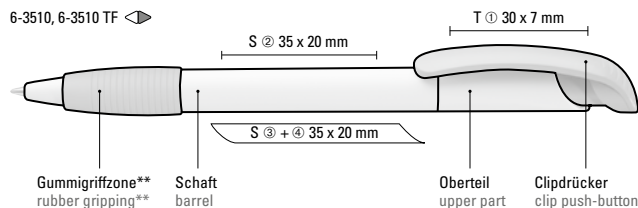

Das gleiche Modell mit Schaft und Clip aus nachwachsendem und kompostierbarem Material finden Sie auf S. 77 unter BIO PEN.

The same model with barrel and clip made of sustainable and biodegradable material can be found on p. 77, under BIO PEN.

Mix n' Match: Alle Teile können farblich frei kombiniert werden.

Mix n' Match: All parts can be colour-combined freely.

6-3500: Druckkugelschreiber mit gedeckt mattem Gehäuse und Bogenclipdrücker.

6-3500: Retractable ballpoint pen with opaque matt housing and curved clip push-button.

6-3510: Druckkugelschreiber mit gedeckt mattem Gehäuse, Bogenclipdrücker und Gummigriffzone.

6-3510: Retractable ballpoint pen with opaque matt housing. Curved clip push-button and rubber grip zone.

6-3500 TF: Druckkugelschreiber mit transparent gefrostetem Gehäuse und Bogenclipdrücker.

6-3500 TF: Retractable ballpoint pen with transparent frosted housing and curved clip push-button.

6-3510 TF: Druckkugelschreiber mit transparent gefrostetem Gehäuse, Bogenclip und Gummigriffzone.

6-3510 TF: Retractable ballpoint pen with transparent frosted housing. Curved clip push-button and rubber grip zone.

** 6-3510 nicht in weiß erhältlich; 6-3510 TF nicht in klar gefrostet erhältlich
** 6-3510 not available in white; 6-3510 TF not available in white transparent frosted

Mindestbestellmenge 1.000 Stück
Werbeschlüssel Schaft S ○, Clip T

Minimum quantity 1,000 pieces
Advertising code barrel S ○, clip T





METALL
METAL



0-6100 (● 8-0888)

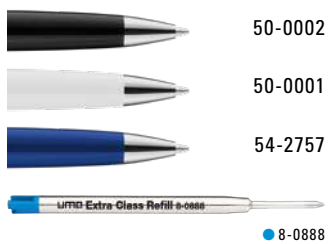

Das Modell eignet sich für Hochglanzlaserung. Siehe Seite 316.

The model is suitable for high gloss laser engraving. See page 316.



myPENbook 9-0500
Beschreibung auf Seite 292.
myPENbook 9-0500
See description on page 292.

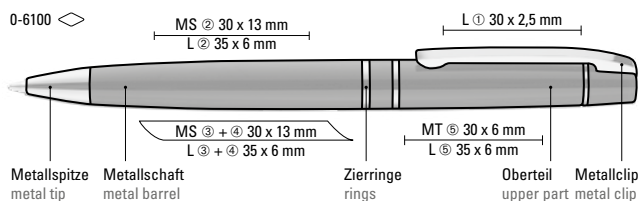

0-6100:
Schlanker Metall-Drehkugelschreiber mit Softdrehmechanik und gefedertem Clip. Beschlagteile glanzverchromt.

Mindestbestellmenge 100 Stück
Werbeschlüssel Schaft MS/L/RL, Clip L, Oberteil MT/L

0-6100:
Slim metal twist ballpoint pen with soft twist mechanism and spring-mounted clip. Metal fittings chrome plated.

Minimum quantity 100 pieces
Advertising code barrel MS/L/RL, clip L, upper part MT/L



0-9100 GUM (● 8-0888)
0-9102 R GUM (●● 8-0806)

54-0002



● 8-0888



●● 8-0806



ETUI 0-0911 W
Beschreibung auf Seite 300.
ETUI 0-0911 W
See description on page 300.



Die Modelle eignen sich für Hochglanzlaserung. Siehe Seite 316.
The models are suitable for high gloss laser engraving. See page 316.

0-9100 GUM:
Metall-Drehkugelschreiber mit Softtouch-Gehäuse, Softdrehmechanik und gefedertem Clip. Beschlagteile schwarz glänzend lackiert.

0-9102 R GUM: Metall-Rollerball mit Softtouch-Gehäuse, gefedertem Clip und schwarzer Gummigriffzone. Beschlagteile schwarz glänzend lackiert.

0-9100 GUM
Mindestbestellmenge 100 Stück
Werbeschlüssel Schaft GT/L, Oberteil GT/L

0-9102 R GUM
Mindestbestellmenge 100 Stück
Werbeschlüssel Schaft GT/L, Kappe GT/L

0-9100 GUM:
Metal twist ballpoint pen with softtouch housing, soft twist mechanism and spring-mounted clip. Fittings glossy black.

0-9102 R GUM: Metal rollerball with softtouch housing, spring-mounted clip and black grip zone. Fittings glossy black.

0-9100 GUM
Minimum quantity 100 pieces
Advertising code barrel GT/L, upper part GT/L

0-9102 R GUM
Minimum quantity 100 pieces
Advertising code barrel GT/L, cap GT/L

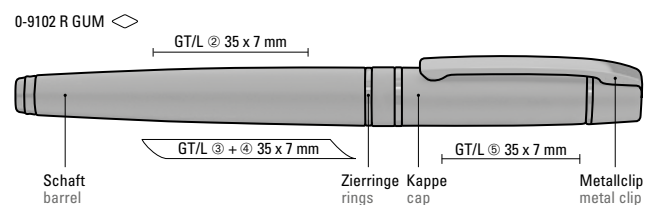
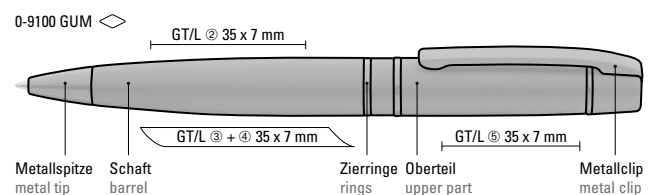

0-9100 (● 8-0888)
0-9102 R (● 8-0806)

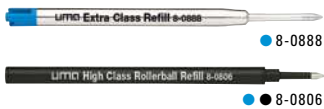

0-9100 GO (● 8-0888)



0-9106 F (● 8-0891)



0-9107 B (0,7 mm)



Die Modelle eignen sich für Rundumlasergravur*.

The models are suitable for 360° laser engraving*.

* nicht für 0-9100 GO möglich
* not possible for 0-9100 GO

LITMO
PRIME

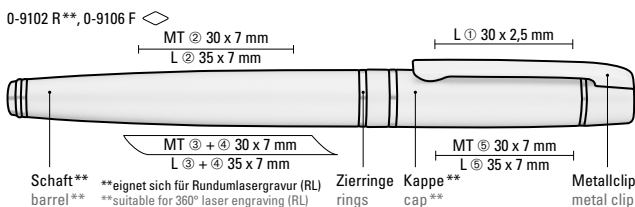
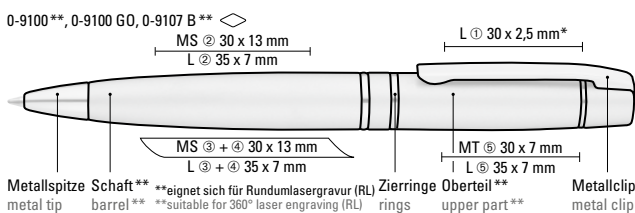

0-9100: Metall-Drehkugelschreiber mit Softdrehmechanik und gefedertem Clip. Beschlagteile glanzverchromt.

0-9100 GO: Metall-Drehkugelschreiber mit Softdrehmechanik und gefedertem Clip. Beschlagteile vergoldet.

0-9102 R: Metall-Rollerball mit gefedertem Clip und schwarzer Gummigriffzone. Beschlagteile glanzverchromt.

0-9106 F: Metall-Füllfederhalter mit Iridiumfeder und gefedertem Clip. Beschlagteile glanzverchromt.

0-9107 B: Metall-Drehbleistift (0,7mm) mit gefedertem Clip. Beschlagteile glanzverchromt.

0-9100, 0-9100 GO, 0-9107 B
Mindestbestellmenge 100 Stück
Werbeschlüssel Schaft MS/L/RL, Clip L*, Oberteil MT/L/RL

0-9102 R, 0-9106 F
Mindestbestellmenge 100 Stück
Werbeschlüssel Schaft MT/L/RL, Clip L, Kappe MT/L/RL

0-9100: Metal twist ballpoint pen with soft twist mechanism and spring-mounted clip. Fittings chrome plated.

0-9100 GO: Metal twist ballpoint pen with soft twist mechanism and spring-mounted clip. Fittings gold plated.

0-9102 R: Metal rollerball with spring-mounted clip and black grip zone. Fittings chrome plated.

0-9106 F: Metal fountain pen with iridium fountain and spring-mounted clip. Fittings chrome plated.

0-9107 B: Metal twist pencil (0.7mm) with soft twist mechanism and spring-mounted clip. Fittings chrome plated.

0-9100, 0-9100 GO, 0-9107 B
Minimum quantity 100 pieces
Advertising code barrel MS/L/RL, clip L*, upper part MT/L/RL

0-9102 R, 0-9106 F
Minimum quantity 100 pieces
Advertising code barrel MT/L/RL, clip L, cap MT/L/RL

TITAN ONE
0-9360

TITAN ONE R
0-9362 R

Farb-Code/Minen
Colour code/
Refills



0-9360 (● 8-0888)
0-9362 R (● 8-0806)

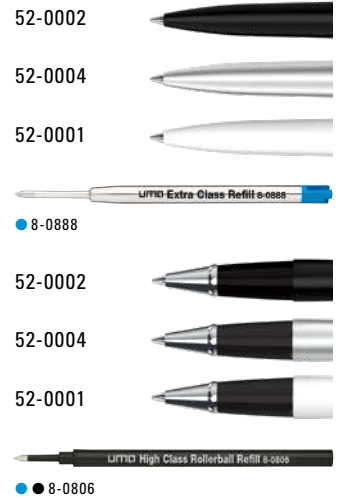

Die Modelle eignen sich für Hochglanzlaserung. Siehe Seite 317.
The models are suitable for high gloss laser engraving. See page 317.

Etui Empfehlung
Case suggestion



Metall ETUI ML 0-0962 ML
Metallklappetui in schwarz oder weiß
siehe Seite 301.
Metal hinged case in black or white
see page 301.

0-9360: Metall-Drehkugelschreiber mit matt lackiertem Gehäuse, Softdrehmechanik und gefedertem, gebürstetem Clip.

0-9362 R: Metall-Rollerball mit matt lackiertem Gehäuse, gefedertem, gebürstetem Clip.

0-9360
Mindestbestellmenge 100 Stück
Werbeschlüssel Schaft MS/L,
Oberteil MT/L

0-9362 R
Mindestbestellmenge 100 Stück
Werbeschlüssel Schaft MT/L,
Kappe MT/L

0-9360: Metal twist ballpoint pen with matt lacquered housing, soft twist mechanism and spring-mounted metal clip brush-finished.

0-9362 R: Metal rollerball with matt lacquered housing, spring-mounted metal clip brush-finished.

0-9360
Minimum quantity 100 pieces
Advertising code barrel MS/L,
upper part MT/L

0-9362 R
Minimum quantity 100 pieces
Advertising code barrel MT/L,
cap MT/L

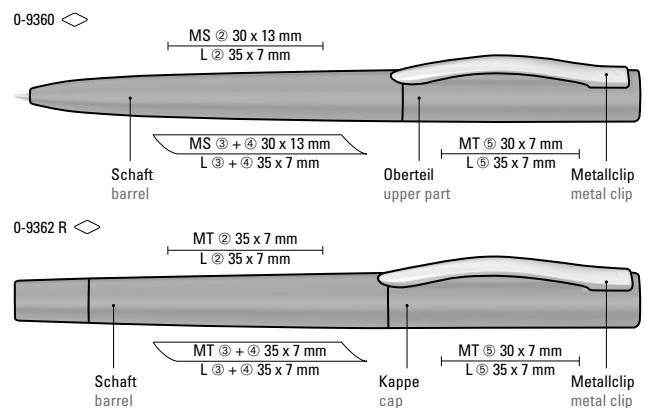

0-9160 M (● 8-0888)
0-9162 MR (● 8-0806)

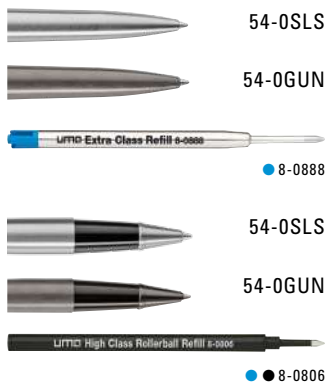

Das Zeichen für verantwortungsvolle Waldwirtschaft

FSC®-zertifizierte Variante

TITAN WOOD

Seite / page 73

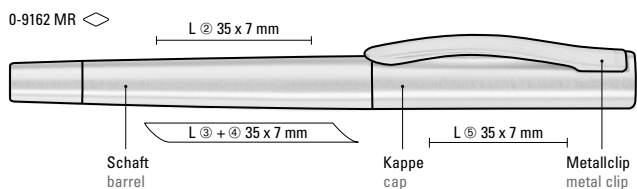
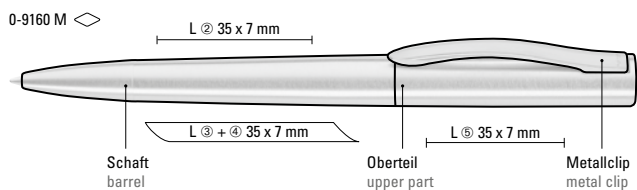

0-9160 M: Metall-Drehkugelschreiber mit Oberfläche in Edelstahl matt gebürstet oder in GUN-Optik, Softdrehmechanik und gefedertem Clip.

0-9162 MR: Metall-Rollerball mit Oberfläche in Edelstahl matt gebürstet oder in GUN-Optik und gefedertem Clip.

0-9160 M
Mindestbestellmenge 100 Stück
Werbeschlüssel Schaft L, Oberteil L

0-9162 MR
Mindestbestellmenge 100 Stück
Werbeschlüssel Schaft L, Kappe L

0-9160 M: Metal twist ballpoint pen with stainless steel matt brushed or GUN metal finish, soft twist mechanism and spring-mounted clip.

0-9162 MR: Metal rollerball with stainless steel matt brushed or GUN metal finish and spring-mounted clip.

0-9160 M
Minimum quantity 100 pieces
Advertising code barrel L, upper part L

0-9162 MR
Minimum quantity 100 pieces
Advertising code barrel L, cap L

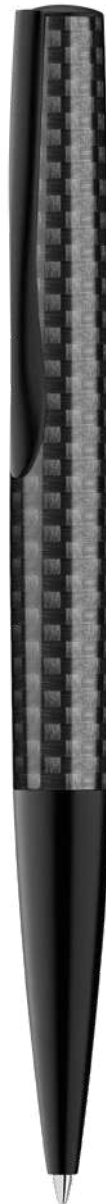
ELEGANCE LUX
0-9190 LUXELEGANCE C
0-9190 CFarb-Code/Minen
Colour code/Refills

0-9190 LUX (● 8-0888)

53-00G0



0-9190 C (● 8-0888)

53-CAR2



53-CAR4



53-CAR3



● 8-0888

Das Zeichen für
verantwortungsvolle
WaldwirtschaftFSC®-zertifizierte Variante
ELEGANCE WOOD

Seite/page 75

0-9190 LUX: Metall-Drehkugelschreiber mit 18 ct vergoldetem Gehäuse, gefederter Metallclip, schwere Metallspitze und Softdrehmechanik.

0-9190 C: Metall-Drehkugelschreiber mit Schaft aus Carbonfaser in schwarz oder silber, gefederter Metallclip und schwere Metallspitze glanzverchromt bzw. Schaft aus Carbonfaser in schwarz, Metallclip und schwere Metallspitze schwarz matt lackiert und Softdrehmechanik.

0-9190 LUX
Mindestbestellmenge 100 Stück
Werbeschlüssel Schaft L, Stopfen L

0-9190 C
Mindestbestellmenge 100 Stück
Werbeschlüssel Schaft MS, Stopfen L

0-9190 LUX: Metal twist ballpoint pen with 18 ct gold plated housing, spring-mounted metal clip, heavy metal tip and soft twist mechanism.

0-9190 C: Metal twist ballpoint pen with carbon fibre barrel in black or silver, spring-mounted metal clip and glossy chrome plated tip or black carbon fibre barrel, spring-mounted metal clip and metal tip in black matt and soft twist mechanism.

0-9190 LUX
Minimum quantity 100 pieces
Advertising code barrel L, plug L

0-9190 C
Minimum quantity 100 pieces
Advertising code barrel MS, plug L

0-9190 LUX ◊

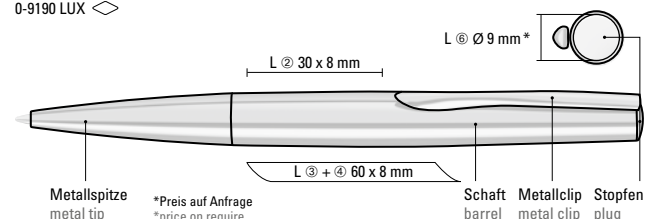

0-9190 C ◊

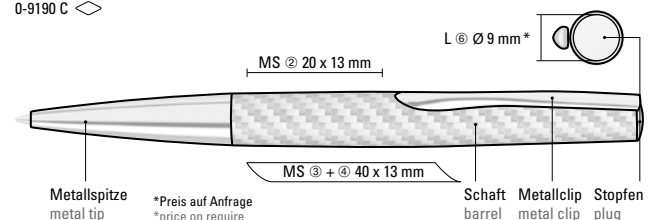

Farb-Code/Minen
Colour code/Refills

ELEGANCE
0-9190

ELEGANCE M
0-9190 M

ELEGANCE GO
0-9190 GO

215



ELEGANCE



Die Modelle eignen sich für Hochglanzlaserung. Siehe Seite 316.

The models are suitable for high gloss laser engraving. See page 316.

Etui Empfehlung
Case suggestion



MetallETUI L 0-0962 ML
Metallklappetui in schwarz oder weiß
siehe Seite 301.

Metal hinged case in black or white
see page 301.

0-9190, 0-9190 M, 0-9190 GO ◊

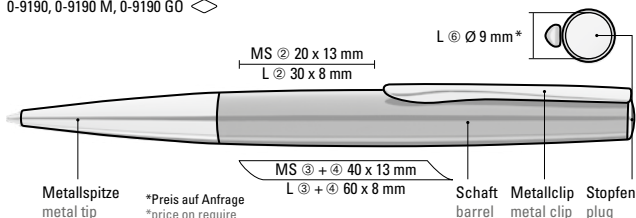

Metallspitze
metal tip

*Preis auf Anfrage
*price on require

Schaft
barrel

Metallclip
metal clip

Stopfen
plug

0-9190: Metall-Drehkugelschreiber mit gedeckt glänzendem Schaft in schwarz oder weiß, gefederter Metallclip, Stopfen, schwere Metallspitze glanzverchromt und Softdrehmechanik.

0-9190 M: Metall-Drehkugelschreiber mit gedeckt matt lackiertem Gehäuse in schwarz, gefederter Metallclip, Stopfen und schwere Metallspitze und Softdrehmechanik.

0-9190 GO: Metall-Drehkugelschreiber mit gedeckt mattem Schaft in schwarz, gefederter Metallclip, Stopfen und schwere Metallspitze in matt vergoldet und Softdrehmechanik.

Mindestbestellmenge 100 Stück
Werbeschlüssel Schaft MS/L, Stopfen L

0-9190: Metal twist ballpoint pen with opaque glossy housing in black or white, spring-mounted metal clip, plug, heavy metal tip chrome plated and soft twist mechanism.

0-9190 M: Metal twist ballpoint pen with matt lacquered housing in black, spring-mounted metal clip, heavy metal tip and soft twist mechanism.

0-9190 GO: Metal twist ballpoint pen with opaque matt housing in black, spring-mounted metal clip, plug, heavy metal tip matt gold plated and soft twist mechanism.

Minimum quantity 100 pieces
Advertising code barrel MS/L, plug L

CARBON
0-8950

CARBON F
0-8956 F

CARBON B
0-8957 B

CARBON R
0-8952 R

Farb-Code/Minen
Colour code/Refills

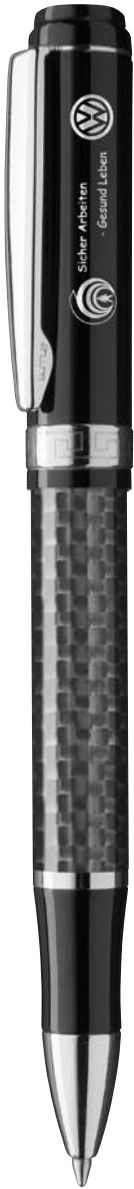

● Ink

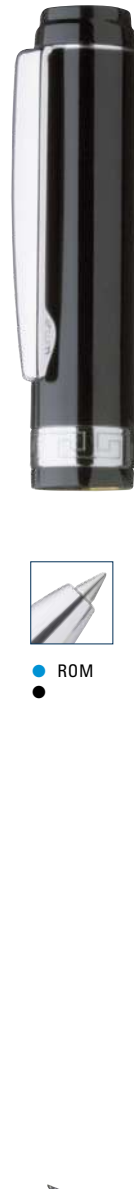

● ROM
●

0-8950 (● 8-0888)

52-0002



● 8-0888

0-8956 F (● 8-0891)

52-0002



● 8-0891



0-8957 B (0,7mm)

52-0002



0-8952 R (● ● 8-0806)

52-0002



● ● 8-0806



Die Modelle eignen sich für Hochglanzlaserung. Siehe Seite 316.

The models are suitable for high gloss laser engraving. See page 316.

CARBON-ETUI 0-0911
Beschreibung auf Seite 300.
CARBON-ETUI 0-0911
See description on page 300.



0-8950, 0-8957 B ◇

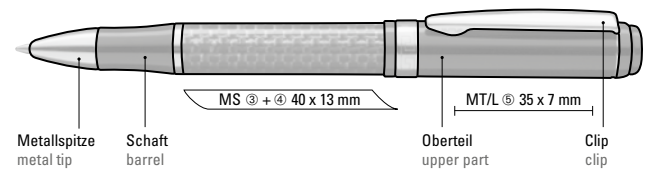

Metallspitze
metal tip

Schaft
barrel

MS ⊕ ⊕ 40 x 13 mm

Oberteil
upper part

Clip
clip

0-8956 F, 0-8952 R ◇

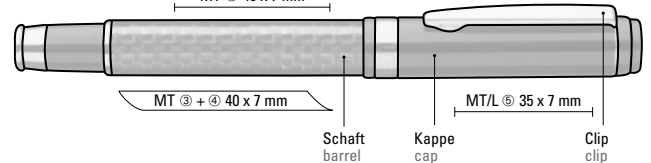

MT ⊕ 40 x 7 mm

Schaft
barrel

Kappe
cap

Clip
clip

MT ⊕ ⊕ 40 x 7 mm

MT/L ⊕ 35 x 7 mm

0-8950: Carbonfaser
Metalldrehkugelschreiber mit
Metallbeschlägen glanzverchromt.

0-8956 F: Carbonfaser
Metallfüllfederhalter mit Iridiumfeder
und Metallbeschlägen glanzverchromt.

0-8957 B: Carbonfaser
Metalldrehbleistift (0,7mm) mit
Radiergummi im Schaft und
Metallbeschlägen glanzverchromt.

0-8952 R: Carbonfaser Metallrollerball
mit Metallbeschlägen glanzverchromt.

0-8950, 0-8957 B
Mindestbestellmenge 100 Stück
Werbeschlüssel Schaft MS, Kappe MT/L

0-8956 F, 0-8952 R
Mindestbestellmenge 100 Stück
Werbeschlüssel Schaft MT, Kappe MT/L

0-8950: Carbon fibre metal twist
ballpoint pen with metal fittings chrome
plated.

0-8956 F: Carbon fibre metal fountain
pen with iridium fountain and metal
fittings chrome plated.

0-8957 B: Carbon fibre metal twist pencil
(0.7mm) with eraser in barrel and metal
fittings chrome plated.

0-8952 R: Carbon fibre metal rollerball
with metal fittings chrome plated.

0-8950, 0-8957 B
Minimum quantity 100 pieces
Advertising code barrel MS, cap MT/L

0-8956 F, 0-8952 R
Minimum quantity 100 pieces
Advertising code barrel MT, cap MT/L

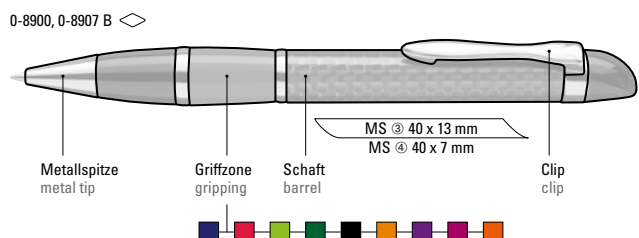
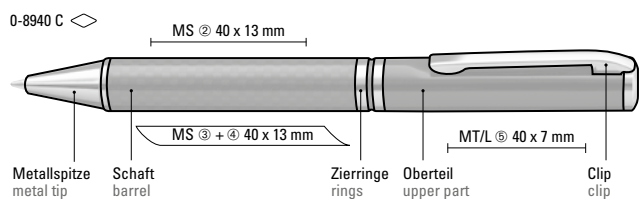
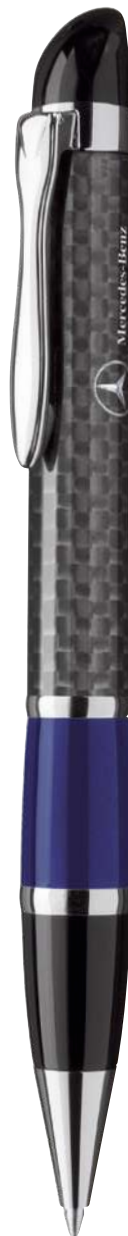

0-8940 C: Carbonfaser Metalldrehkugelschreiber mit zwei eingelassenen silbernen Ringen und Kappe in schwarz. Metallbeschlagteile glanzverchromt.

0-8900: Edler Carbonfaser Metalldrehkugelschreiber mit farbiger Griffzone, flexiblem Metallclip, Metallzierring und Metallspitze glanzverchromt.

0-8907 B: Edler Carbonfaser Metalldrehbleistift (0,7mm) mit farbiger Griffzone, flexiblem Metallclip, Metallzierring und Metallspitze glanzverchromt.

0-8940: Carbon fibre metal twist ballpoint pen with two recessed silver rings and cap in black. Metal fittings glanzverchromt.

0-8900: Carbon fibre metal twist ballpoint pen with coloured grip zone, flexible metal clip, metal ring and metal tip chrome plated.

0-8907 B: Carbon fibre metal twist pencil (0.7mm) with coloured grip zone, flexible metal clip, metal ring and metal tip chrome plated.

0-8940 C
Mindestbestellmenge 100 Stück
Werbeschlüssel Schaft MS, Kappe MT/L
0-8900, 0-8907 B
Mindestbestellmenge 100 Stück
Werbeschlüssel Schaft MS

0-8940 C
Minimum quantity 100 pieces
Advertising code barrel MS, cap MT/L
0-8900, 0-8907 B
Minimum quantity 100 pieces
Advertising code barrel MS



0-8370 (● 8-0856)



0-8372 R (●● 8-0806)



0-8370 M (● 8-0856)



0-8372 MR (●● 8-0806)



Die Modelle eignen sich für Hochglanzlaserung. Siehe Seite 316.

The models are suitable for high gloss laser engraving. See page 316.



Etui Empfehlung / Case suggestion

ETUI 0-0944
Zweiteiliges Pappetui mit abnehmbarem Deckel und W-Einlage – siehe Seite 299.

Two-piece cardboard case with removable lid and W-inlay – see on page 299.

0-8370, 0-8370 M ◊

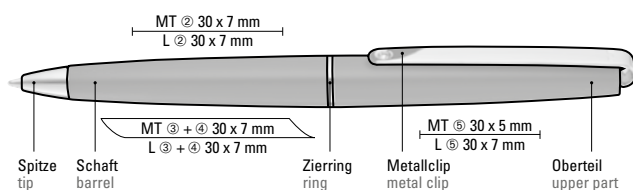

0-8372 R, 0-8372 MR ◊

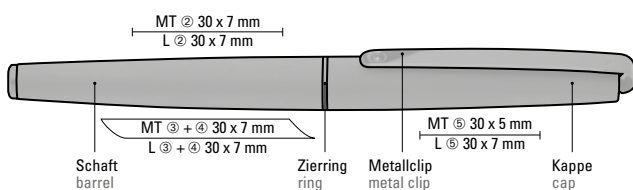

0-8370: Metall-Drehkugelschreiber mit Softdrehmechanik und glänzendem Gehäuse. Langer flexibler Metallclip, Zierring und Spitze glanzverchromt.

0-8372 R: Metall-Rollerball mit glänzendem Gehäuse. Langer flexibler Metallclip, Zierring und Stopfen glanzverchromt. Griffzone gerillt glanzverchromt.

0-8370 M: Metall-Drehkugelschreiber mit Softdrehmechanik und matt lackiertem Gehäuse. Langer flexiblem Metallclip, Zierring und Spitze schwarz glänzend.

0-8372 MR: Metall-Rollerball mit matt lackiertem Gehäuse. Langer flexibler Metallclip, Zierring und Stopfen schwarz glänzend. Griffzone gerillt schwarz glänzend.

Mindestbestellmenge
Werbeschlüssel

300 Stück
Schaft MT/L,
Kappe MT/L

0-8370: Metal twist ballpoint pen with soft twist mechanism, glossy housing. Long, flexible metal clip, ring and tip chrome plated.

0-8372 R: Metal rollerball with glossy housing. Long, flexible metal clip, ring and plug chrome plated. Ribbed grip zone chrome plated.

0-8370 M: Metal twist ballpoint pen with soft twist mechanism, matt lacquered housing. Long, flexible metal clip, ring and tip glossy black.

0-8372 MR: Metal rollerball with matt lacquered housing. Long, flexible metal clip, ring and plug glossy black. Ribbed grip zone glossy black.

Minimum quantity
Advertising code

300 pieces
barrel MT/L,
cap MT/L



0-9350 (● 8-0888)



0-9352 R (● ● 8-0806)



Das Modell in schwarz eignet sich für eine Hochglanzlasergravur in silber. Siehe Seite 316.

The model in black is suitable for high gloss laser engraving in silver. See page 316.



Die Modelle in silber und GUN eignen sich für eine Laserung in beige. Siehe Seite 316.

The models in silver and GUN are suitable for laser engraving in beige. See page 316.



0-9350 ◊

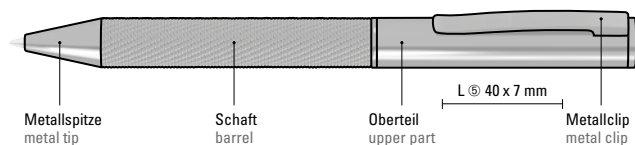

0-9350: Metall-Drehkugelschreiber glänzend lackiert mit Softdrehmechanik und gefedertem Metallclip. Schaft mit integriertem Meshband.

0-9350: Metal twist ballpoint pen in glossy lacquered finish with a soft twist mechanism and a spring-mounted metal clip. Barrel with integrated mesh band.

0-9352 R ◊

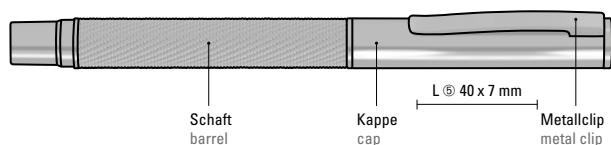

0-9352 R: Metall-Rollerball glänzend lackiert mit gefedertem Metallclip und Schaft mit integriertem Meshband.

0-9352 R: Metal rollerball in glossy lacquered finish with spring-mounted metal clip and barrel with integrated mesh band.

0-9350
Mindestbestellmenge
Werbeschlüssel

100 Stück
Oberteil L

0-9350
Minimum quantity
Advertising code

100 pieces
upper part L

0-9352 R
Mindestbestellmenge
Werbeschlüssel

100 Stück
Kappe L

0-9352 R:
Minimum quantity
Advertising code

100 pieces
cap L



0-9940 (● 8-0888)
0-9942 R (● ● 8-0806)
0-9943 PR (● 8-0901)

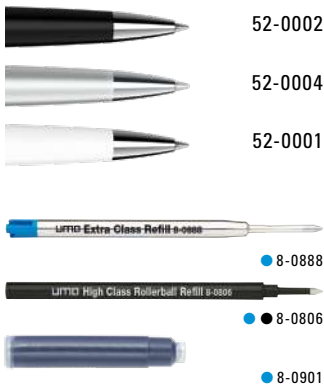

uma Patronen-Roller-System

Das uma Patronen-Roller-System ist die innovative Basis für neuartige Tintenroller-Schreibgeräte in Premium-Qualität. Dank seiner speziell entwickelten, verschleißarmen Kugelspitze punktet es mit einer bisher unerreichten Langlebigkeit und arbeitet nach dem Prinzip des Füllhalters und kann mit Standard-Tintenpatronen nachgefüllt werden. Die Schreibspitze mit TC-Kugel (0,7 mm) wird also immer wieder verwendet und nicht weggeworfen. So sind, mit dem uma Patronen-Roller-System ausgestattete Schreibgeräte nicht nur sehr wirtschaftlich, sondern auch in besonderem Maße umweltfreundlich.

uma cartridge roller system

The uma cartridge roller system is an innovative basis for novel rollerball writing instruments in premium quality. Thanks to its specifically developed wear-resistant ball tip, the uma cartridge roller system excels in an unrivalled longevity and operates on the same principle as the fountain pen and can be refilled with standard ink cartridges. Thus, the TC ball tip (0.7 mm) can be reused again and again and will not be disposed of. This makes these writing instruments not only extremely economical, but also very environmentally friendly.



Patronen-Roller-System/uma cartridge roller system

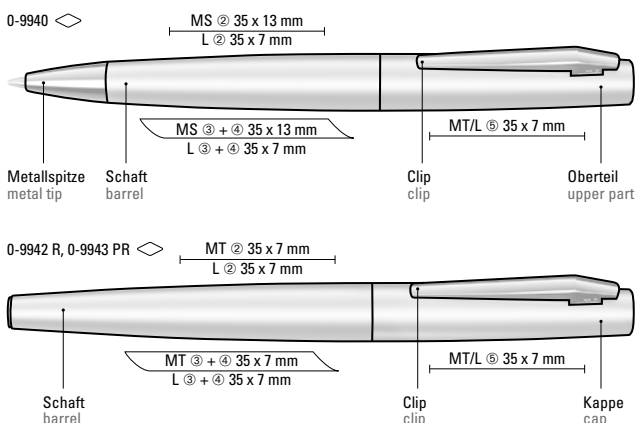

0-9940: Metall-Drehkugelschreiber mit matt lackiertem Gehäuse und Softdrehmechanik. Metallclip, Metallspitze und Stopfen glanzverchromt.

0-9942 R: Metall-Rollerball mit matt lackiertem Gehäuse. Metallclip und Stopfen glanzverchromt.

0-9943 PR: Metall-Patronen-Roller mit matt lackiertem Gehäuse. Metallclip und Stopfen glanzverchromt. Das Patronen-Roller-System arbeitet nach dem Prinzip des Füllhalters und kann mit Standard-Tintenpatronen nachgefüllt werden.

0-9940
Mindestbestellmenge
Werbeschlüssel

100 Stück
Schaft MS/L,
Oberteil MT/L

0-9942 R, 0-9943 PR
Mindestbestellmenge
Werbeschlüssel

100 Stück
Schaft MT/L,
Kappe MT/L

0-9940: Metal twist ballpoint pen with matt lacquered housing and soft twist mechanism. Metal clip, metal tip and plug chrome plated.

0-9942 R: Metal rollerball with matt lacquered housing. Metal clip and plug chrome plated.

0-9943 PR: Metal cartridge roller with matt lacquered housing. Metal clip and plug chrome plated. The cartridge roller system operates on the same principle as the fountain pen and can be refilled with standard ink cartridges.

0-9940
Minimum quantity
Advertising code

100 pieces
barrel MS/L,
upper part MT/L

0-9942 R, 0-9943 PR
Minimum quantity
Advertising code

100 pieces
barrel MT/L,
cap MT/L

CLASSICO M
0-8800 M

SILENCE LE
0-9180 LE

SILENCE LE R
0-9182 LE R

Farb-Code/Minen
Colour code/Refills



0-8800 M (● 8-0883)

53-0002



LITKO Economy Class Refill 0-0883

● 8-0883

0-9180 LE (● 8-0888)

55-0002



LITKO Extra Class Refill 0-0888

● 8-0888

0-9182 LE R (● 8-0806)

55-0002



LITKO High Class Rollerball Refill 0-0806

● 8-0806

0-8800 M: Metall-Drehkugelschreiber mit glänzend lackiertem Gehäuse in schwarz. Clip, Zierringe und Spitze aus vergoldetem Metall.

0-9180 LE: Metall-Drehkugelschreiber mit Lederschaft und weißen Ziernähten. Oberteil und Beschläge glanzverchromt.

0-9182 LE R: Metall-Rollerball mit Lederschaft und weißen Ziernähten. Kappe und Beschläge glanzverchromt.

0-8800 M
Mindestbestellmenge 300 Stück
Werbeschlüssel Schaft MS/L, Clip L, Oberteil MT/L

0-9180 LE
Mindestbestellmenge 100 Stück
Werbeschlüssel Oberteil L

0-9182 LE R
Mindestbestellmenge 100 Stück
Werbeschlüssel Kappe L

0-8800 M: Metal twist ballpoint pen with glossy lacquered body in black. Metal clip, metal rings and metal tip gold-plated.

0-9180 LE: Metal twist ballpoint pen with leather barrel and white decorative stitchings. Upper part and fittings chrome plated.

0-9182 LE R: Metal rollerball with leather barrel and white decorative stitchings. Upper part and fittings chrome plated.

0-8800 M
Minimum quantity 300 pieces
Advertising code barrel MS/L, clip L, upper part MT/L

0-9180 LE
Minimum quantity 100 pieces
Advertising code upper part L

0-9182 LE R
Minimum quantity 100 pieces
Advertising code cap L

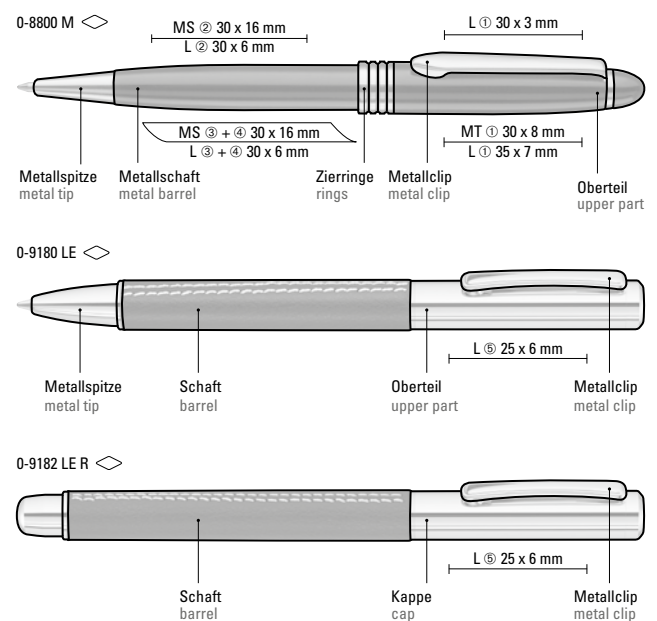

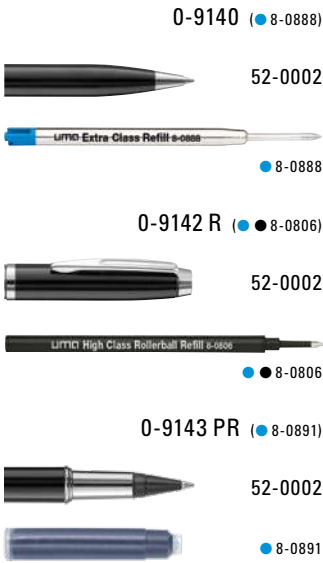

Die Modelle eignen sich für Hochglanzlaserung. Siehe Seite 316.
The models are suitable for high gloss laser engraving. See page 316.

uma Patronen-Roller-System

Das uma Patronen-Roller-System ist die innovative Basis für neuartige Tintenroller-Schreibgeräte in Premium-Qualität. Dank seiner speziell entwickelten, verschleißarmen Kugelspitze punktet es mit einer bisher unerreichten Langlebigkeit und arbeitet nach dem Prinzip des Füllhalters und kann mit Standard-Tintenpatronen nachgefüllt werden.

Die Schreibspitze mit TC-Kugel (0,7 mm) wird also immer wieder verwendet und nicht weggeworfen. So sind, mit dem uma Patronen-Roller-System ausgestattete Schreibgeräte nicht nur sehr wirtschaftlich, sondern auch in besonderem Maße umweltfreundlich.

uma cartridge roller system

The uma cartridge roller system is an innovative basis for novel rollerball writing instruments in premium quality. Thanks to its specifically developed wear-resistant ball tip, the uma cartridge roller system excels in an unrivalled longevity and operates on the same principle as the fountain pen and can be refilled with standard ink cartridges. Thus, the TC ball tip (0.7 mm) can be reused again and again and will not be disposed of. This makes these writing instruments not only extremely economical, but also very environmentally friendly.



Patronen-Roller-System/uma cartridge roller system

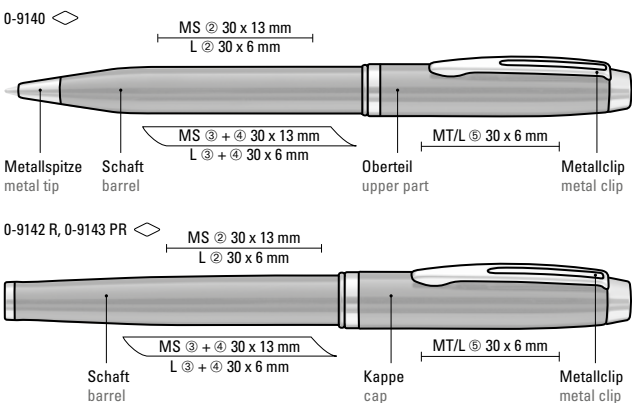

0-9140: Metall-Drehkugelschreiber mit Softdrehmechanik und Metallzierring. Beschlagteile glanzverchromt.

0-9142 R: Metall-Rollerball mit Metallzierring. Beschlagteile glanzverchromt.

0-9143 PR: Metall-Patronen-Roller mit Metallzierring. Beschlagteile glanzverchromt. Das Patronen-Roller-System arbeitet nach dem Prinzip des Füllhalters und kann mit Standard-Tintenpatronen nachgefüllt werden.

0-9140
Mindestbestellmenge 100 Stück
Werbeschlüssel Schaft MS/L, Oberteil MT/L

0-9142 R, 0-9143 PR
Mindestbestellmenge 100 Stück
Werbeschlüssel Schaft MT/L, Kappe MT/L

0-9140: Metal twist ballpoint pen with soft twist mechanism and decorative metal ring. Metal fittings chrome plated.

0-9142 R: Metal rollerball with decorative metal ring. Metal fittings chrome plated.

0-9143 PR: Metal cartridge roller with decorative metal ring. Metal fittings chrome plated. The cartridge roller system operates on the same principle as the fountain pen and can be refilled with standard ink cartridges.

0-9140
Minimum quantity 100 pieces
Advertising code Schaft MS/L, upper part MT/L

0-9142 R, 0-9143 PR
Minimum quantity 100 pieces
Advertising code Schaft MT/L, cap MT/L



360°
HIGH GLOSS
LITMI

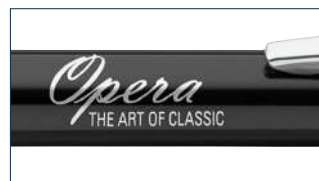

Die Modelle eignen sich für Hochglanzlaserung. Siehe Seite 317.
The models are suitable for high gloss laser engraving. See page 317.



Die Modelle eignen sich für Rundumlasergravur in Hochglanz.
The models are suitable for 360° laser engraving high gloss.

0-9900 (● 8-0888)



0-9900 M (● 8-0888)

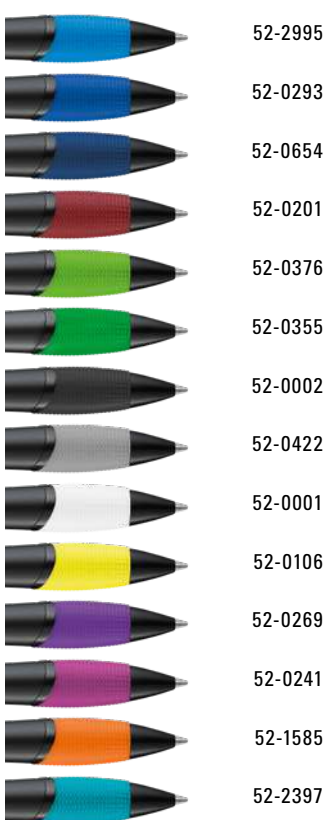

● 8-0888



ETUI 0-0917
Beschreibung auf Seite 300.
See description on page 300.

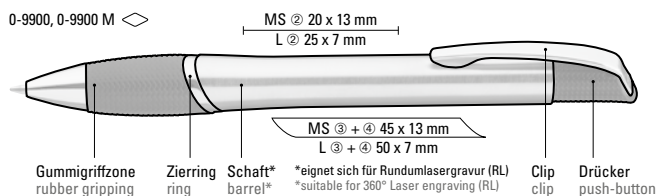

0-9900: Metall-Druckkugelschreiber mit glänzendem Gehäuse, schwarzer Gummigriffzone und glanzverchromten Beschlagteilen.

0-9900 M: Metall-Druckkugelschreiber mit schwarz matt lackiertem Gehäuse, farbige Gummigriffzone und matt schwarzen Beschlagteilen.

Mindestbestellmenge 300 Stück
Werbeschlüssel Schaft MS/L/RL

0-9900: Metal retractable ballpoint pen with glossy housing, black rubber grip zone and fittings chrome plated.

0-9900 M: Metal retractable ballpoint pen with matt black lacquered housing, coloured rubber grip zone and fittings matt black.

Minimum quantity 300 pieces
Advertising code barrel MS/L/RL





Wir
Wie se
Zeit da
was he
auf ein
Jahr, m
alles w
mal ve
war, ein

as soll au
er so bleibe
er, dass wir
orher, ganz
h oder sch
durch die
r das, was
schön!
eiben Sie
schichte



VEREDELUNG FINISHING





VIP
siehe Seite 211
see page 211



STRAIGHT
siehe Seite 239 / 241 / 243
see page 239 / 241 / 243



GLÄNZENDE AUSSICHTEN

Elegant, effektiv, edel – mit unseren innovativen Veredelungsverfahren werden aus Metall-Schreibgeräten unvergesslich glanzvolle Werbeträger.



ELEGANCE
siehe Seite 215
see page 215



OPERA
siehe Seite 227
see page 227



TITAN ONE
siehe Seite 212
see page 212

BRILLIANT PROSPECTS

Elegant, decorative, noble – with our innovative finishing methods, we transform metal writing instruments into unforgettable, glamorous promotional tools.





Das Modell 0-9610 GUM eignet sich für Hochglanzlaserung. Siehe Seite 317.

The model 0-9610 GUM is suitable for high gloss laser engraving. See page 317.

0-9610 GUM (● 8-0844)
0-9612 R GUM (● 8-0806)

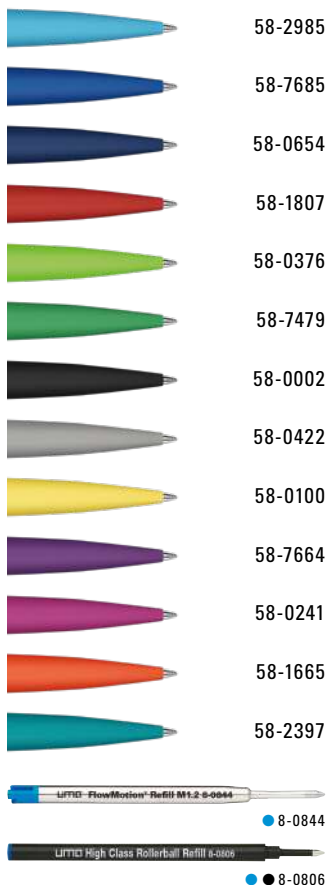

*feel the
FlowMotion*



0-9610 GUM ◊

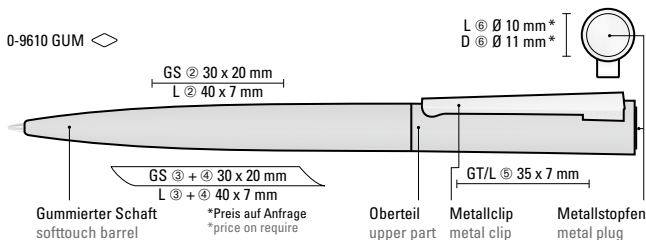

L ⑥ Ø 10 mm*
D ⑥ Ø 11 mm*

UMA FlowMotion®

Mit der neuen uma FlowMotion® Schreibtechnologie. Siehe Seite 305.
With the new uma FlowMotion® writing technology. See on page 305.

0-9610 GUM: Metall-Drehkugelschreiber mit Softtouch-Gehäuse, gefederter Metallclip und Stopfen matt verchromt.

0-9610 GUM: Metal twist ballpoint pen with softtouch housing, spring-mounted metal clip and plug matt chromed.

0-9612 R GUM: Metall-Rollerball mit Softtouch-Gehäuse, gefederter Metallclip und Stopfen matt verchromt.

0-9612 R GUM: Metal rollerball with softtouch housing, spring-mounted metal clip and plug matt chromed.

0-9160 GUM
Mindestbestellmenge 300 Stück
Werbeschlüssel Schaft GS/L,
Oberteil GT/L, Stopfen L*/D*

0-9610 GUM
Minimum quantity 300 pieces
Advertising code barrel GS/L,
upper part GT/L, plug L*/D*

0-9612 R GUM ◊

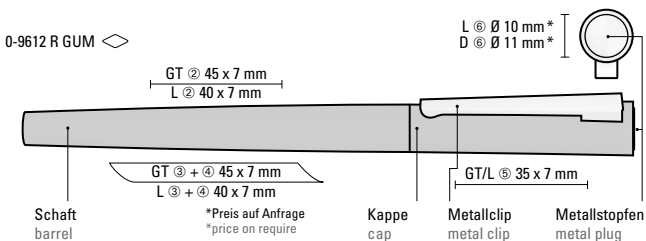

L ⑥ Ø 10 mm*
D ⑥ Ø 11 mm*

0-9162 R GUM
Mindestbestellmenge 300 Stück
Werbeschlüssel Schaft GT/L,
Kappe GT/L, Stopfen L*/D*

0-9162RGUM
Minimum quantity 300 pieces
Advertising code barrel GT/L,
cap GT/L, plug L*/D*



0-9630 GUM (● 8-0855)

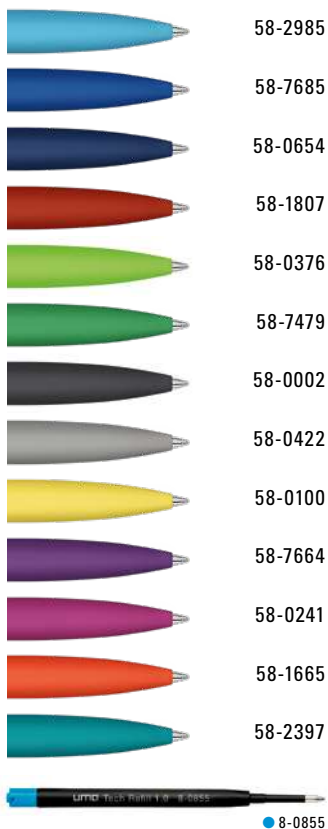

Das Modell 0-9630 GUM eignet sich für Hochglanzlaserung. Siehe Seite 317.

The model 0-9630 GUM is suitable for high gloss laser engraving. See page 317.



0-9630 GUM ◊

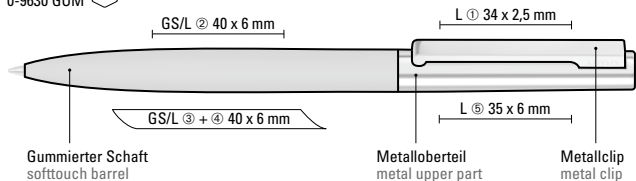

0-9630 GUM: Metall-Drehkugelschreiber mit Softtouch-Schaft, glanzverchromtem Metalloberteil und gefederter Metallclip.

Mindestbestellmenge 300 Stück
Werbeschlüssel Schaft GS/L, Kappe L, Clip L

0-9630 GUM: Metal twist ballpoint pen with softtouch barrel, upper part chrome plated and spring-mounted metal clip.

Minimum quantity 300 pieces
Advertising code barrel GS/L, cap L, clip L



0-9540 GUM (● 8-0855)

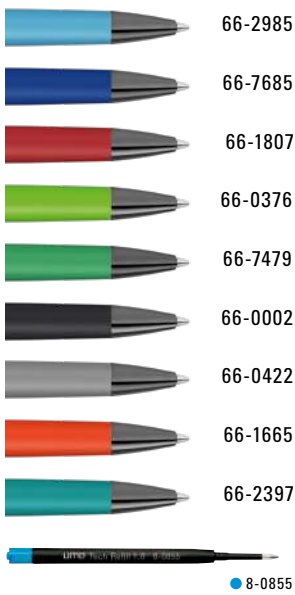

Ellipsenförmiger Softtouch-Schaft
Elliptical soft touch barrel



Das Modell 0-9540 GUM eignet sich für Hochglanzlaserung.
Siehe Seite 317.

The model 0-9540 GUM is suitable for high gloss laser engraving.
See page 317.

0-9540 GUM ◊

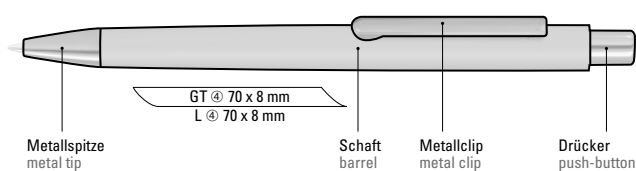

0-9540 GUM:
Metall-Druckkugelschreiber mit ellipsenförmigem Softtouch-Gehäuse. Metallclip, Metallspitze und ellipsenförmiger Drücker GUN metallic.

Mindestbestellmenge
Werbeschlüssel

300 Stück
Schaft GT/L

0-9540 GUM:
Metal retractable ballpoint pen with elliptical softtouch housing. Metal clip, metal tip and elliptical push-button gun metallic.

Minimum quantity
Advertising code

300 pieces
barrel GT/L



STRAIGHT
STRAIGHT SI TOUCH
0-9450 SI TO

STRAIGHT SI R TOUCH
0-9452 SI R TO

Farb-Code/Minen
Colour code/Refills



0-9450 SI TO (● 8-0855)

0-9452 SI R TO (● 8-0806)

58-2995



58-0293



58-0654



58-0201



58-0376



58-0355



58-0002



58-0422



58-0004



58-0001



58-0106

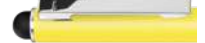

58-0269

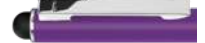

58-0241

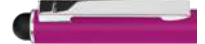

58-1585



58-2397

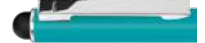

● 8-0855



● 8-0806

0-9450 SI TO: Metall-Drehkugelschreiber mit mattem Gehäuse. Metallclip und Metallspitze silber glänzend. Gummiertes Schaftende für die Touchscreensteuerung.

0-9452 SI R TO: Metall-Rollerball mit mattem Gehäuse. Metallclip und Zierring silber glänzend, Griffzone schwarz. Gummiertes Schaftende für die Touchscreensteuerung.

0-9450 SI TO
Mindestbestellmenge 300 Stück
Werbeschlüssel Schaft MS/L, Clip L, Oberteil MT/L

0-9452 SI R TO
Mindestbestellmenge 300 Stück
Werbeschlüssel Schaft MT/L, Clip L, Kappe MT/L

0-9450 SI TO: Metal twist ballpoint pen with matt housing. Metal clip and metal tip and push-button chrome plated. Black rubber ball with integrated touch screen control.

0-9452 SI R TO: Metal rollerball with matt housing. Metal clip and ring chrome plated, grip zone black. Black rubber ball with integrated touch screen control.

0-9450 SI TO
Minimum quantity 300 pieces
Advertising code barrel MS/L, clip L, upper part MT/L

0-9452 SI R TO
Minimum quantity 300 pieces
Advertising code barrel MT/L, clip L, cap MT/L

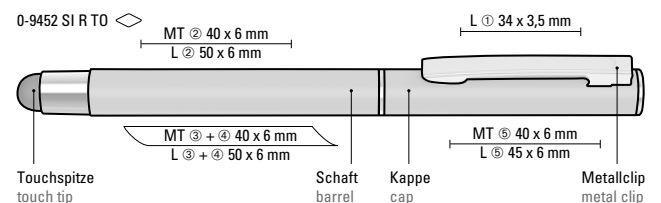
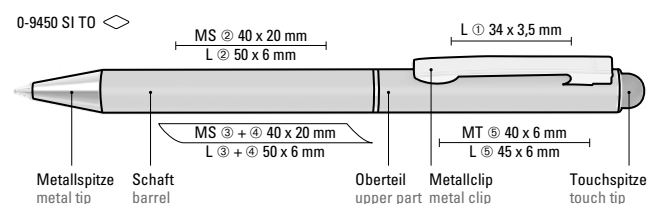

0-9450 SI (● 8-0855)
0-9457 SI B (0,7 mm)

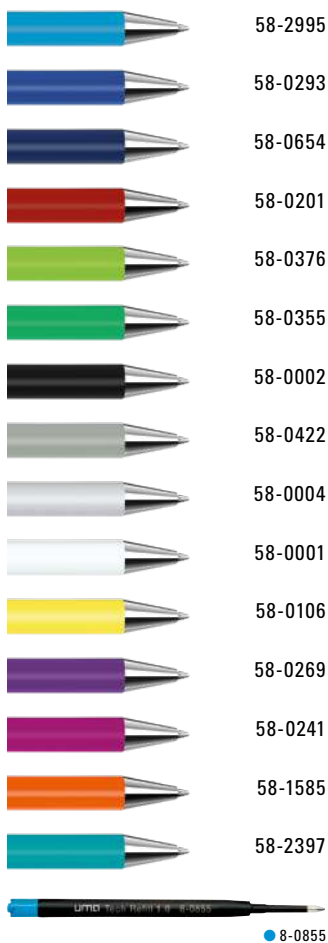

UMA
PRIME



0-9450 SI, 0-9457 SI B ◊

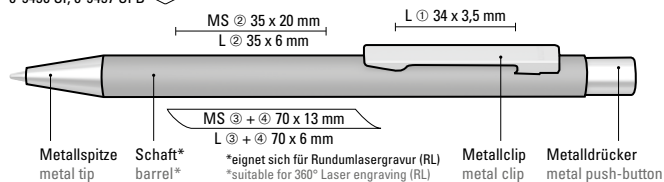

0-9450 SI: Metall-Druckkugelschreiber mit mattem Gehäuse. Metallclip, Metallspitze und Drücker silber glänzend.

0-9457 SI B: Metall-Druckbleistift (0,7mm) mit mattem Gehäuse. Metallclip, Metallspitze und Drücker silber glänzend. Radiergummi im Drücker.

0-9450 SI, 0-9457 SI B
Mindestbestellmenge 300 Stück
Werbeschlüssel Schaft MS/L/RL, Clip L

0-9450 SI: Metal retractable ballpoint pen with matt housing. Metal clip, metal tip and push-button chrome plated.

0-9457 SI B: Metal retractable pencil (0,7mm) with matt housing. Metal clip, metal tip and push-button chrome plated. Rubber inside the push-button.

0-9450 SI, 0-9457 SI B
Minimum quantity 300 pieces
Advertising code barrel MS/L/RL, clip L



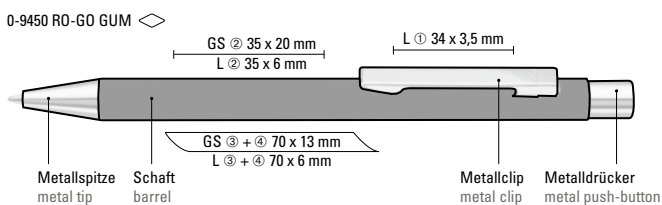
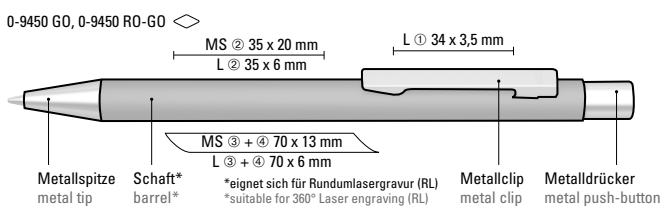

0-9450 GO: Metall-Druckkugelschreiber mit mattem Gehäuse in weiß oder schwarz. Metallclip, Metallspitze und Drücker gold glänzend.

0-9450 RO-GO: Metall-Druckkugelschreiber mit glänzendem Gehäuse in weiß oder mattem Gehäuse in schwarz. Metallclip, Metallspitze und Drücker roségold glänzend.

0-9450 RO-GO GUM: Metall-Druckkugelschreiber mit Softtouch-Gehäuse in schwarz. Metallclip, Metallspitze und Drücker roségold glänzend.

0-9450 GO, 0-9450 RO-GO
Mindestbestellmenge 300 Stück
Werbeschlüssel Schaft MS/L/RL, Clip L

0-9450 RO-GO GUM
Mindestbestellmenge 300 Stück
Werbeschlüssel Schaft GS/L, Clip L

0-9450 GO: Metal retractable ballpoint pen with matt housing in black or white. Metal clip, metal tip and push-button gold plated.

0-9450 RO-GO: Metal retractable ballpoint pen with glossy housing in white or matt black. Metal clip, metal tip and push-button rose gold plated.

0-9450 RO-GO GUM: Metal retractable ballpoint pen with softtouch housing in black. Metal clip, metal tip and push-button rose gold plated.

0-9450 GO, 0-9450 RO-GO
Minimum quantity 300 pieces
Advertising code barrel MS/L/RL, clip L

0-9450 RO-GO GUM
Minimum quantity 300 pieces
Advertising code barrel GS/L, clip L

STRAIGHT GUM
0-9450 GUMSTRAIGHT GUM B
0-9457 GUM BSTRAIGHT M GUM
0-9450 M GUMFarb-Code/Minen
Colour code/Refills
0-9450 GUM (● 8-0855)
0-9457 GUM B (0,7mm)

58-2985



58-7685



58-0654



58-1807



58-0376



58-7479



58-0002



58-0422



58-0100



58-7664



58-0241



58-1665



58-2397



0-9450 M GUM (● 8-0855)

58-0002



● 8-0855

Die Modelle eignen sich für
Hochglanzlaserung. Siehe Seite 317.The models are suitable for high gloss
laser engraving. See page 317.0-9450 GUM:
Metall-Druckkugelschreiber mit
Softtouch-Gehäuse. Metallclip,
Metallspitze und Drücker GUN metallic.0-9457 GUM B: Metall-Druckbleistift
(0,7mm) mit Softtouch-Gehäuse.
Metallclip, Metallspitze und Drücker
GUN metallic. Radiergummi im Drücker.0-9450 M GUM:
Metall-Druckkugelschreiber mit
Softtouch-Gehäuse. Metallclip,
Metallspitze und Drücker schwarz
glänzend.Mindestbestellmenge 300 Stück
Werbeschlüssel Schaft GS/L, Clip L0-9450 GUM:
Metal retractable ballpoint pen with
softtouch housing. Metal clip, metal tip
and push-button GUN metallic.0-9457 GUM B: Metal retractable pencil
(0.7mm) with softtouch housing. Metal
clip, metal tip and push-button GUN
metallic. Rubber inside the push-button.0-9450 M GUM:
Metal retractable ballpoint pen with
softtouch housing. Metal clip, metal tip
and push-button glossy black.Minimum quantity 300 pieces
Advertising code barrel GS/L, clip L

0-9450 GUM, 0-9450 M GUM, 0-9457 GUM B ◊

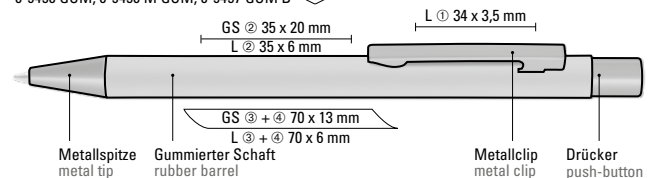

Farb-Code/Minen
Colour code/Refills

STRAIGHT
0-9450

STRAIGHT B
0-9457 B

STRAIGHT M
0-9450 M

243

STRAIGHT

0-9450 (● 8-0855)
0-9457 B (0,7mm)



0-9450 M (● 8-0855)

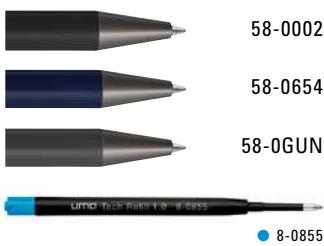

Die Modelle eignen sich für
Hochglanzlaserung. Siehe Seite 317.

The models are suitable for high gloss
laser engraving. See page 317.



0-9450, 0-9457 B, 0-9450 M ◊

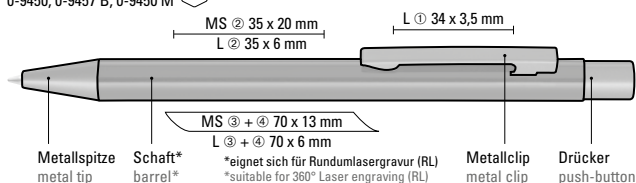

0-9450: Metall-Druckkugelschreiber mit
glänzendem Gehäuse. Metallclip,
Metallspitze und Drücker GUN metallic.

0-9457 B: Metall-Druckbleistift (0,7mm)
mit glänzendem Gehäuse. Metallclip,
Metallspitze und Drücker GUN metallic.
Radiergummi im Drücker.

0-9450 M: Metall-Druckkugelschreiber
mit mattem Gehäuse. Metallclip,
Metallspitze und Drücker GUN metallic.

Mindestbestellmenge 300 Stück
Werbeschlüssel Schaft MS/L/RL, Clip L

0-9450: Metal retractable ballpoint pen
with glossy housing. Metal clip, metal tip
and push-button GUN metallic.

0-9457 B: Metal retractable pencil
(0.7mm) with matt housing. Metal clip,
metal tip and push-button GUN metallic.
Rubber inside the push-button.

0-9450 M: Metal retractable ballpoint
pen with matt housing. Metal clip, metal
tip and push-button GUN metallic.

Minimum quantity 300 pieces
Advertising code barrel MS/L/RL, clip L



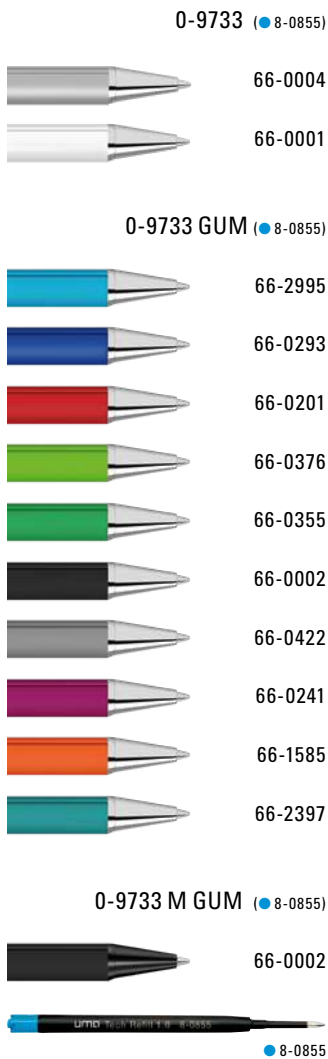

Dreikantiger Softtouch-Schaft
Triangular soft touch barrel



Die Modelle eignen sich für
Hochglanzlaserung. Siehe Seite 317.
The models are suitable for high gloss
laser engraving. See page 317.

0-9733 ◊

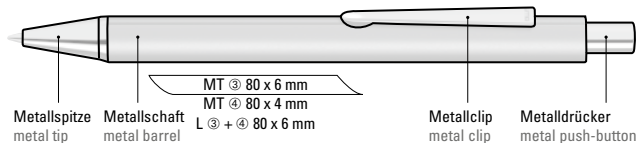

0-9733 GUM, 0-9733 M GUM ◊

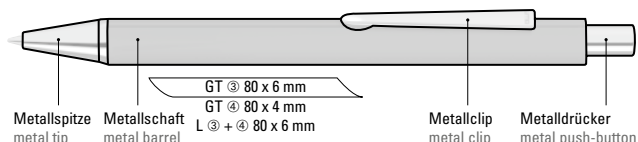

0-9733: Metall-Druckkugelschreiber mit mattem Dreikantgehäuse, Metallclip, Metallspitze und Drücker in silber glänzend.

0-9733 GUM:
Metall-Druckkugelschreiber mit Softtouch-Dreikantgehäuse, Metallclip, Metallspitze und Drücker in silber glänzend.

0-9733 M GUM:
Metall-Druckkugelschreiber mit Softtouch-Dreikantgehäuse, Metallclip, Metallspitze und Drücker in schwarz matt.

0-9733
Mindestbestellmenge 300 Stück
Werbeschlüssel Schaft MT/L

0-9733 GUM, 0-9733 M GUM
Mindestbestellmenge 300 Stück
Werbeschlüssel Schaft GT/L

0-9733: Metal retractable ballpoint pen with triangular barrel matt finished, metal clip, metal tip and push-button in glossy silver.

0-9733 GUM: Metal retractable ballpoint pen with softtouch triangular barrel, metal clip, metal tip and push-button in glossy silver.

0-9733 M GUM:
Metal retractable ballpoint pen with softtouch triangular barrel, metal clip, metal tip and push-button in matt black.

0-9733
Minimum quantity 300 pieces
Advertising code Schaft MT/L

0-9733 GUM, 0-9733 M GUM
Minimum quantity 300 pieces
Advertising code Schaft GT/L

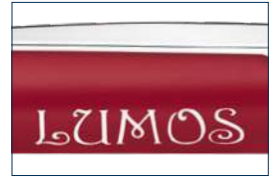

Das Modell 0-9560 eignet sich für Laserung in weiß.
Siehe Seite 317.

The model 0-9560 is suitable for engraving in white.
See page 317.



Das Modell 0-9560 GUM eignet sich für Hochglanzlaserung.
Siehe Seite 317.

The model 0-9560 GUM is suitable for high gloss laser engraving.
See page 317.



Das Modell 0-9560 M GUM eignet sich für Laserung in schwarz.
Siehe Seite 317.

The model 0-9560 M GUM is suitable for engraving in black.
See page 317.

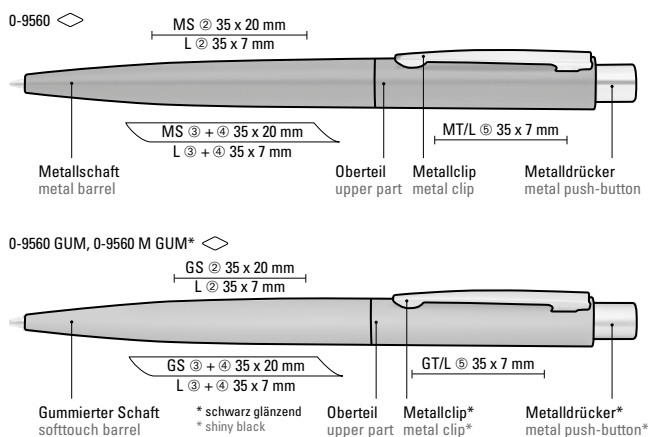
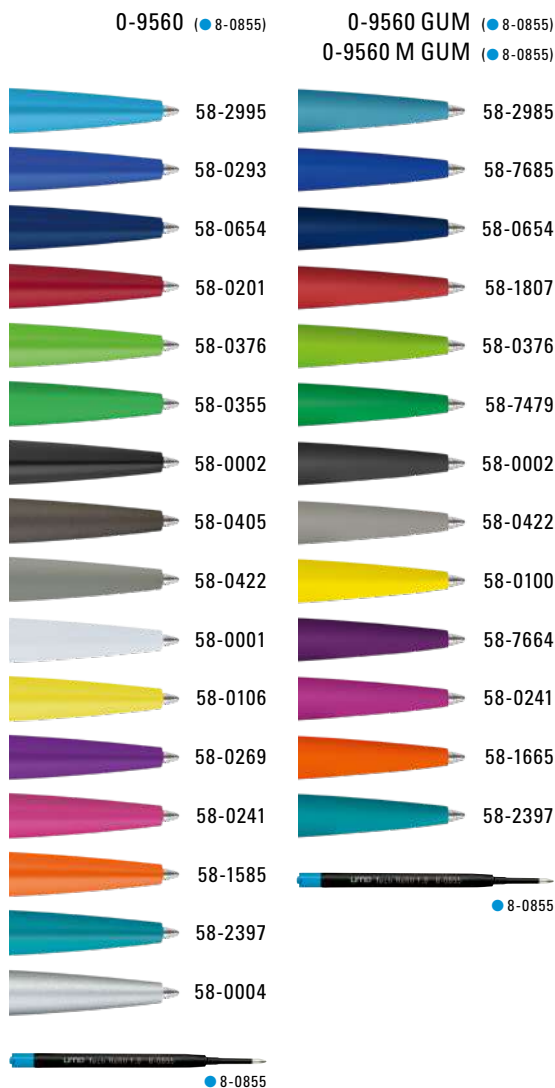

0-9560: Metall-Druckkugelschreiber mit matt lackiertem Gehäuse. Metallclip und Drücker glanzverchromt.

0-9560 GUM: Metall-Druckkugelschreiber mit Softtouch-Gehäuse. Metallclip und Drücker matt verchromt.

0-9560 M GUM: Metall-Druckkugelschreiber mit Softtouch-Gehäuse. Metallclip und Drücker schwarz glänzend.

0-9560
Mindestbestellmenge 300 Stück
Werbeschlüssel Schaft MS/L, Oberteil MT/L

0-9560 GUM, 0-9560 M GUM
Mindestbestellmenge 300 Stück
Werbeschlüssel Schaft GS/L, Oberteil GT/L

0-9560: Metal retractable ballpoint pen with matt lacquered housing. Metal clip and push-button chrome plated.

0-9560 GUM: Metal retractable ballpoint pen with softtouch housing. Metal clip and push-button matt chromed.

0-9560 M GUM: Metal retractable ballpoint pen with softtouch housing. Metal clip and push-button glossy black.

0-9560
Minimum quantity 300 pieces
Advertising code barrel MS/L, upper part MT/L

0-9560 GUM, 0-9560 M GUM
Minimum quantity 300 pieces
Advertising code barrel GS/L, upper part GT/L



0-9560 STONE (● 8-0855)



Das Modell 0-9560 STONE eignet sich für Laserung in weiß. Siehe Seite 317.

The model 0-9560 STONE is suitable for engraving in white. See page 317.

0-9560 STONE ◊

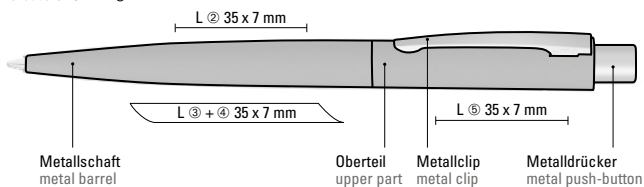

0-9560 STONE:
Metall-Druckkugelschreiber mit nachgestellter Beton- bzw. Steinoptik und Haptik. Metallclip und Drücker matt verchromt.

Mindestbestellmenge 300 Stück
Werbeschlüssel Schaft L, Oberteil L

0-9560 STONE:
Metal retractable ballpoint pen with reconstructed concrete or stone optics and haptics. Metal clip and push-button matt chromed.

Minimum quantity 300 pieces
Advertising code barrel L, upper part L



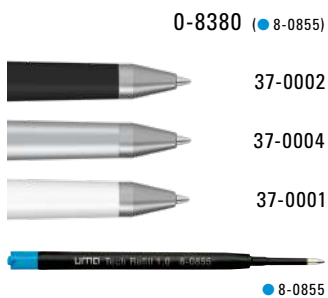

Das Modell 0-8380 eignet sich für Laserung in weiß. Siehe Seite 316.

The model 0-8380 is suitable for engraving in white. See page 316.

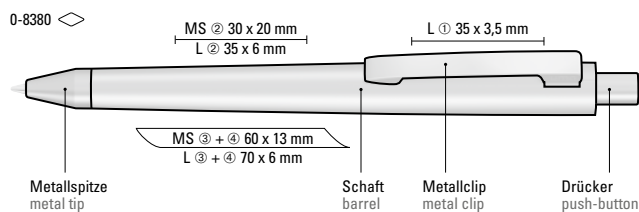

0-8380: Metall-Druckkugelschreiber mit matt lackiertem Gehäuse. Metallclip, Metallspitze und Drücker matt verchromt.

Mindestbestellmenge 300 Stück
Werbeschlüssel Schaft MS/L, Clip L

0-8380: Metal retractable ballpoint pen with matt lacquered housing. Metal clip, metal tip and push-button matt chromed.

Minimum quantity 300 pieces
Advertising code barrel MS/L, clip L



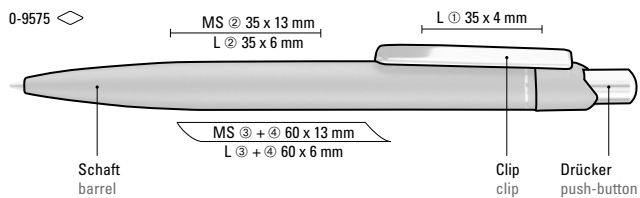
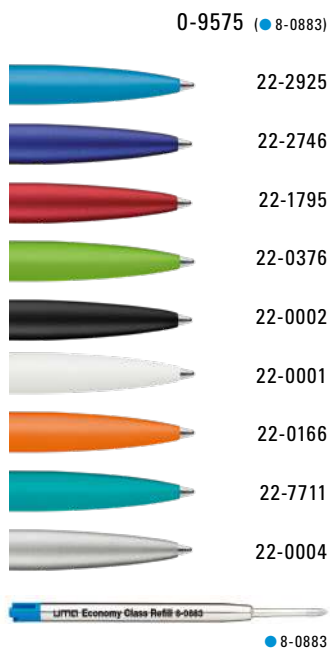

















0-9575: Metall-Druckkugelschreiber mit matt lackiertem Aluminiumschaft. Metallclip und Drücker silber glanzverchromt.

Mindestbestellmenge 300 Stück
Werbeschlüssel Schaft MS/L, Clip L

0-9575: Metal retractable ballpoint pen with matt lacquered aluminium housing. Metal clip and push-button chrome plated.

Minimum quantity 300 pieces
Advertising code barrel MS/L, clip L



- 0-9530** (● 8-0855)
-  66-2995
 -  66-0293
 -  66-0201
 -  66-0376
 -  66-0355
 -  66-0002
 -  66-0001
 -  66-0241
 -  66-1585
 -  66-2397
 -  66-0004
- 0-9530 M** (● 8-0855)
-  66-0002
 -  66-0001
- 0-9530 TO** (● 8-0855)
-  66-0002
 -  66-0001
 -  ● 8-0855

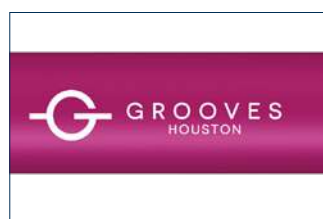

Die Modelle eignen sich für Laserung in weiß. Siehe Seite 317.

The models are suitable for laser engraving in white. See page 317.

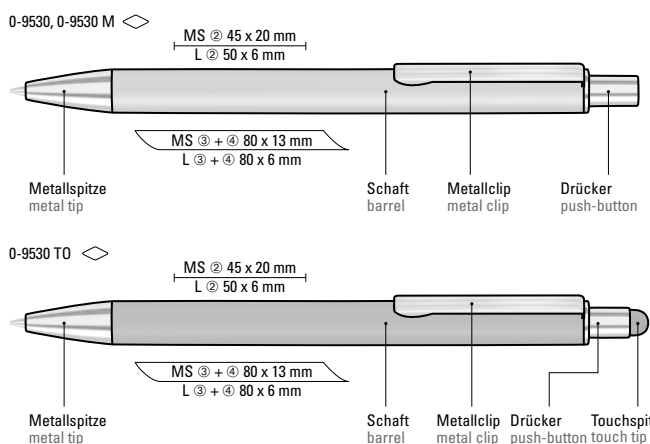

0-9530: Metall-Druckkugelschreiber mit matter Oberfläche, Metallclip mit eingelassenen Rillen, Metallspitze und Drücker in silber glänzend.

0-9530 M: Metall-Druckkugelschreiber mit matter Oberfläche, Metallclip mit eingelassenen Rillen, Metallspitze und Drücker in schwarz matt.

0-9530 TO: Metall-Druckkugelschreiber mit matter Oberfläche, Metallclip mit eingelassenen Rillen, Metallspitze in silber glänzend und Drücker mit integrierter Touchscreensteuerung.

Mindestbestellmenge
Werbeschlüssel

300 Stück
Schaft MS/L

0-9530: Metal retractable ballpoint pen with matt finish, metal clip with recessed grooves, metal tip and push-button in glossy silver.

0-9530 M: Metal retractable ballpoint pen with matt finish, metal clip with recessed grooves, metal tip and push-button in matt black.

0-9530 TO: Metal retractable ballpoint pen with matt finish, metal clip with recessed grooves, metal tip in glossy silver and push-button with integrated touch screen control.

Minimum quantity
Advertising code

300 pieces
barrel MS/L





Sechskantiges Gehäuse
Hexagonal barrel

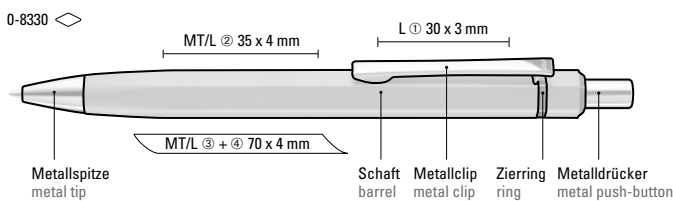

0-8330: Metall-Druckkugelschreiber mit matt lackiertem, sechskantigem Aluminiumschaft. Metallclip, Metallspitze und Drücker silber glänzend. Zierring schwarz glänzend.

Mindestbestellmenge 300 Stück
Werbeschlüssel Schaft MT/L, Clip L

0-8330: Metal retractable ballpoint pen with matt lacquered, hexagonal aluminium barrel. Metal clip, metal tip and push-button in glossy silver. Ring in glossy black.

Minimum quantity 300 pieces
Advertising code barrel MT/L, clip L



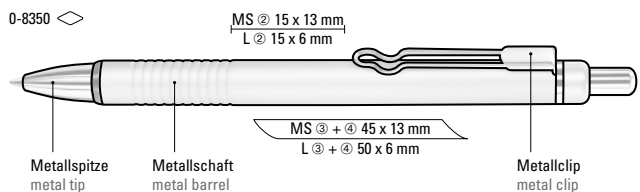
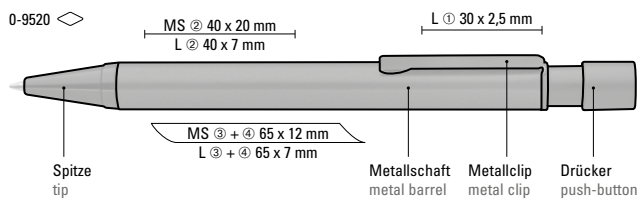
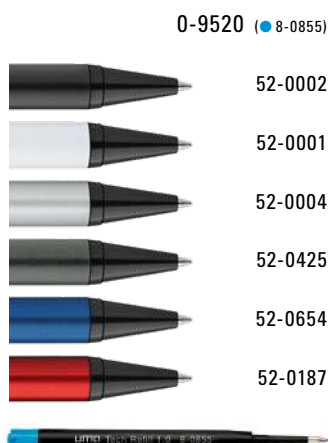

0-9520: Metall-Druckkugelschreiber mit matt lackiertem Gehäuse. Metalldrücker, Metallclip und Spitze schwarz matt.

0-8350: Metall-Druckkugelschreiber mit matt lackiertem Aluminiumschäfte und integrierter Griffzone. Metallbügelclip und Beschläge glanzverchromt. Zierring schwarz.

0-9520: Metal retractable ballpoint pen with matt lacquered housing. Metal clip, push-button and tip matt black.

0-8350: Metal retractable ballpoint pen with matt lacquered aluminium barrel and integrated grip zone. Metal clip and fittings chrome plated. Ring black.

0-9520
Mindestbestellmenge 300 Stück
Werbeschlüssel Schaft MS/L, Clip L

0-8350
Mindestbestellmenge 300 Stück
Werbeschlüssel Schaft MS/L

0-9520
Minimum quantity 300 pieces
Advertising code barrel MS/L, clip L

0-8350
Minimum quantity 300 pieces
Advertising code barrel MS/L



0-9460 (● 8-0883)

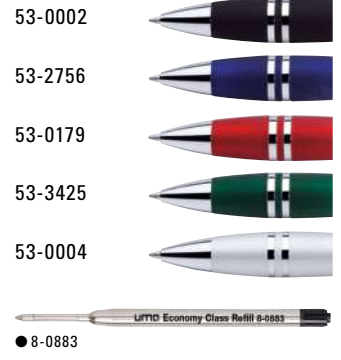

0-9470 (● 8-0883)

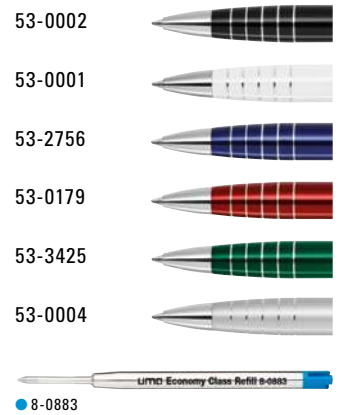

0-9460: Metall-Druckkugelschreiber mit glanzverchromten Beschlägen.

0-9470: Metall-Druckkugelschreiber mit silbernen Zierringen im Gehäuse und elastischem Metallclip. Spitze und Drücker silber glänzend.

Mindestbestellmenge 300 Stück
Werbeschlüssel Schaft MS/L, Clip L

0-9460: Metal retractable ballpoint pen with glossy chrome fittings.

0-9470: Metal retractable ballpoint pen with silver rings on the barrel, elastic metal clip. Tip and push-button silver glossy.

Minimum quantity 300 pieces
Advertising code barrel MS/L, clip L

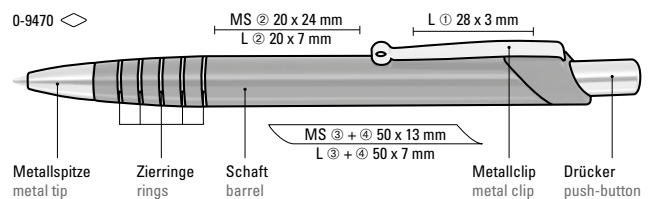
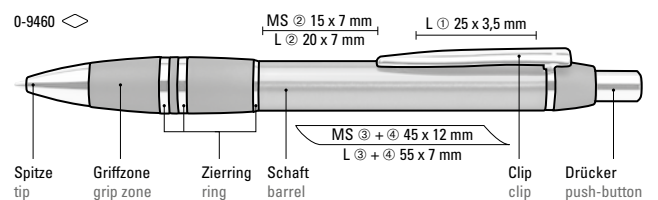

0-9412 (● 8-0883)

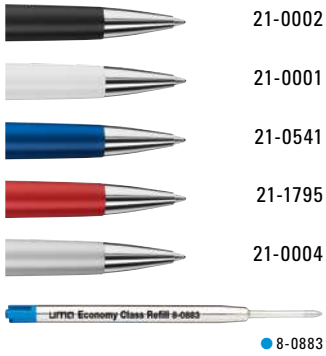

0-9412 ◊

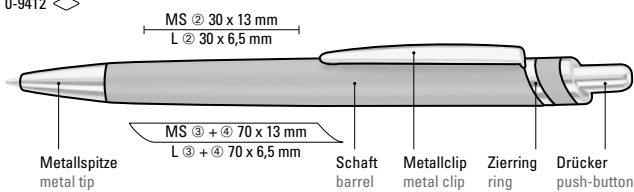

0-9412: Metall-Druckkugelschreiber mit
matt lackiertem Aluminiumschaft.
Beschlagteile glanzverchromt.

Mindestbestellmenge
Werbeschlüssel

300 Stück
Schaft MS/L

0-9412: Metal retractable ballpoint pen
with matt lacquered aluminium housing.
Fittings chrome plated.

Minimum quantity
Advertising code

300 pieces
barrel MS/L

ARGON
0-9400

ARGUS L
0-9480 L

Farb-Code/Minen
Colour code/Refills



0-9400 (● 8-0883)

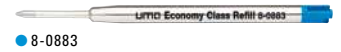
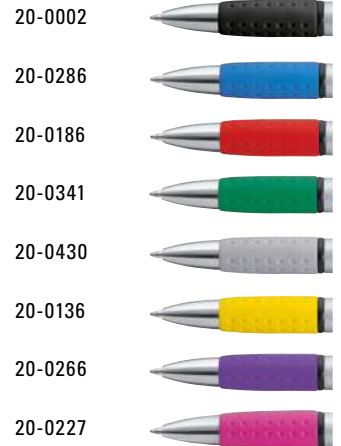

0-9480 L (● 8-0883)

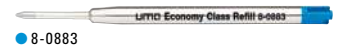
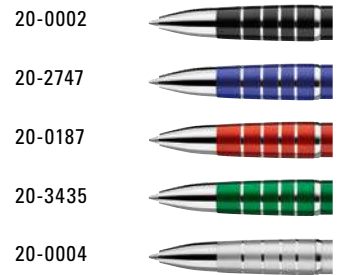

0-9400: Metall-Druckkugelschreiber mit Aluminiumschaft, Metallclip und farbiger Gummigriffzone.

0-9480 L: Metall-Druckkugelschreiber mit lackiertem Aluminiumschaft, Metallclip und Griffzone mit Ringdesign glanzverchromt.

Mindestbestellmenge 300 Stück
Werbeschlüssel Schaft MS/L, Clip L

0-9400: Metal retractable ballpoint pen with aluminium housing, metal clip and coloured rubber grip zone.

0-9480 L: Metal retractable ballpoint pen with lacquered aluminium housing, metal clip and ring-design grip zone chrome plated.

Minimum quantity 300 pieces
Advertising code barrel MS/L, clip L

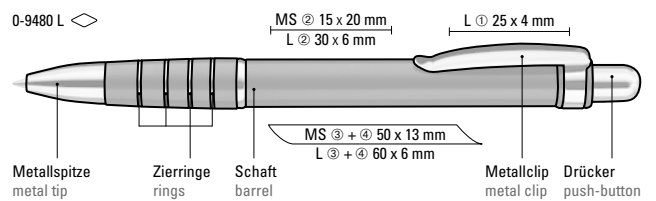
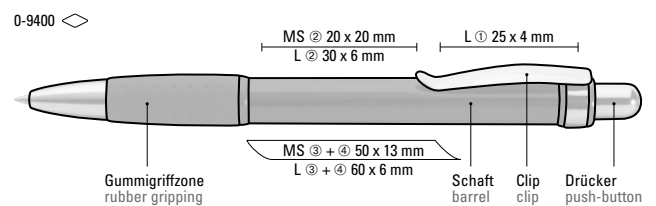

0-9440 (● 8-0883)



0-0196 L (● 8-0866)

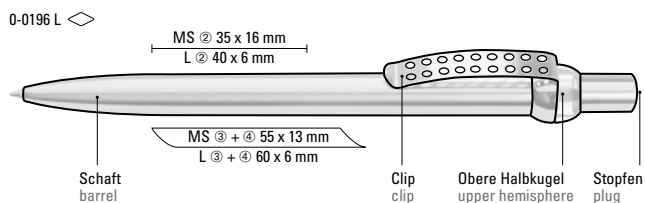
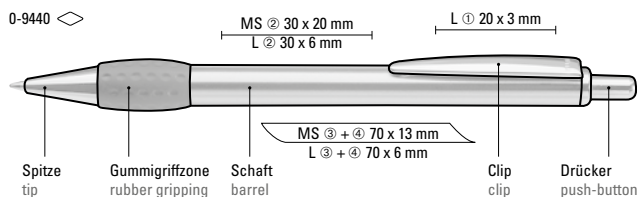

0-9440: Metall-Druckkugelschreiber mit Schaft, Drücker, Clip und Spitze glanzverchromt. Gummigriffzone farbig.

0-0196 L: Metall-Druckkugelschreiber mit verchromtem und lackiertem Schaft. Obere Halbkugel und Stopfen farbig transparent. Gelochter Metallclip, Drücker und untere Halbkugel verchromt.

0-9440
Mindestbestellmenge 300 Stück
Werbeschlüssel Schaft MS/L, Clip L

0-0196 L
Mindestbestellmenge 300 Stück
Werbeschlüssel Schaft MS/L

0-9440: Metal retractable ballpoint pen with housing, push-button, clip and tip chrome plated. Coloured rubber grip zone.

0-0196 L: Metal retractable ballpoint pen with chrome and lacquered barrel. Upper hemisphere and plug in transparent colour. Metal clip, push-button and lower hemisphere chrome plated.

0-9440
Minimum quantity 300 pieces
Advertising code barrel MS/L, clip L

0-0196 L
Minimum quantity 300 pieces
Advertising code barrel MS/L



Farb-Code/Minen
Colour code/Refills

COMMA
0-9438

LUCKY
0-9415

265

0-9438 (● 8-0883)



0-9415 (● 8-0855)



0-9438 ◊

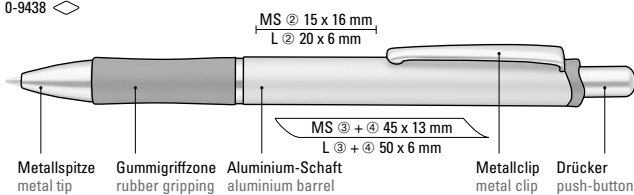

0-9415 ◊

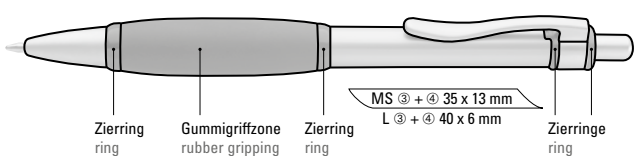

0-9438: Metall-Druckkugelschreiber mit lackiertem Aluminiumschaft. Schwarzer Gummigriffzone und Metallclip.

0-9415: Metall-Druckkugelschreiber mit Schaft, Drücker, Clip und Spitze glanzverchromt. Große, farbige Gummigriffzone.

Mindestbestellmenge
Werbeschlüssel

300 Stück
Schaft MS/L

0-9438: Metal retractable ballpoint pen with lacquered aluminum barrel. Black rubber grip zone and metal clip.

0-9415: Metal retractable ballpoint pen with barrel, push-button, clip and tip chrome plated. Large coloured rubber grip zone.

Minimum quantity
Advertising code

300 pieces
barrel MS/L



0-8240 (● 8-0855)

57-0002

57-0004

57-0001

● 8-0855

0-8242 R (● 8-0806)

57-0002

57-0004

57-0001

● 8-0806

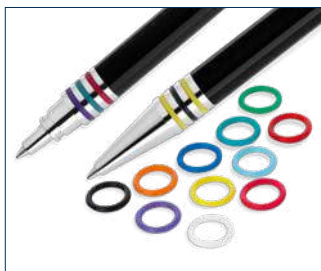

Bereits ab 300 Stück können die Ringe farblich kombiniert werden.

You may choose any colour combination for the three rings for orders over 300 units.



0-8240 ◀

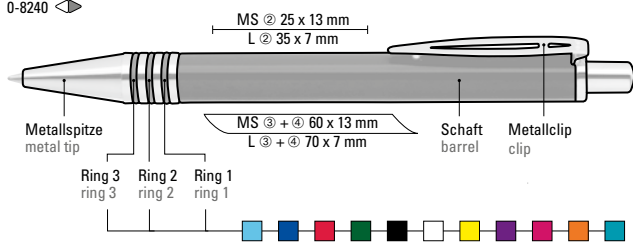

0-8242 R ◀

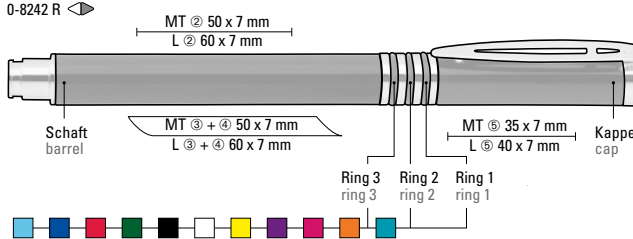

0-8240: Metall-Druckkugelschreiber mit glänzend lackiertem Aluminiumschaft und 3 eingelassenen, kombinierbaren Gummiringen. Metallbeschlagteile glanzverchromt.

0-8242 R: Metall-Rollerball mit glänzend lackiertem Aluminiumschaft und 3 eingelassenen, kombinierbaren Gummiringen. Metallbeschlagteile glanzverchromt.

0-8240
Mindestbestellmenge 300 Stück
Werbeschlüssel Schaft MS/L

0-8242 R
Mindestbestellmenge 300 Stück
Werbeschlüssel Schaft MT/L,
Kappe MT/L

0-8240: Metal retractable ballpoint pen with glossy lacquered aluminum housing and 3 recessed combinable rubber rings in the barrel. Metal fittings chrome plated.

0-8242 R: Metal rollerball with glossy lacquered aluminum housing and 3 recessed combinable rubber rings in the barrel. Metal fittings chrome plated.

0-8240
Minimum quantity 300 pieces
Advertising code barrel MS/L

0-8242 R
Minimum quantity 300 pieces
Advertising code barrel MT/L,
cap MT/L



0-8250 (● 8-0883)
0-8250 DOM (● 8-0883)

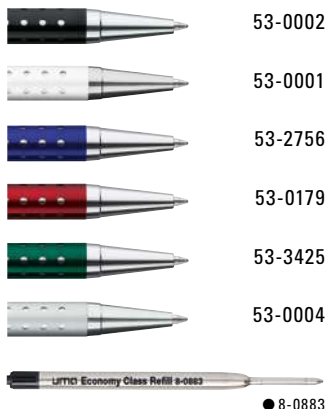

Die Modelle eignen sich für Hochglanzlaserung. Siehe Seite 316.

The models are suitable for high gloss laser engraving. See page 316.

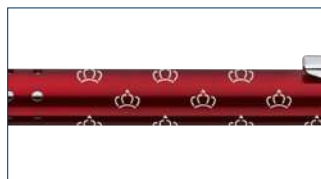

Doming Stopfen
Doming plug Ø 7 mm

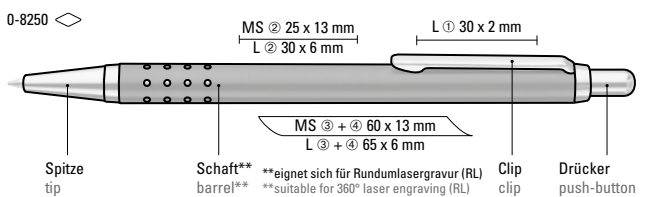

0-8250: Metall-Druckkugelschreiber lackiert mit gelochter Griffzone. Metallbeschlagteile glanzverchromt.

0-8250: Slim metal retractable ballpoint pen with lacquered housing and perforated grip zone. Metal fittings chrome plated.

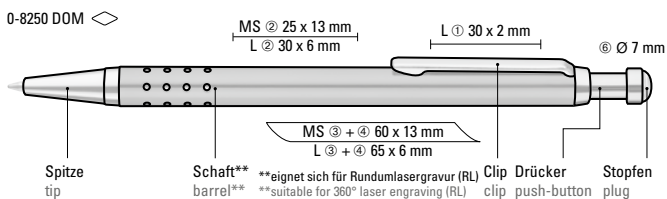

0-8250 DOM: Metall-Druckkugelschreiber lackiert mit gelochter Griffzone. Metallbeschlagteile glanzverchromt. Drücker mit individuell gestaltetem Doming.

0-8250 DOM: Slim metal retractable ballpoint pen with lacquered housing and perforated grip zone. Metal fittings chrome plated and individual designable doming.

0-8250
Mindestbestellmenge 300 Stück
Werbeschlüssel Schaft MS/L/RL, Clip L

0-8250 DOM
Mindestbestellmenge 500 Stück
Werbeschlüssel Schaft MS/L/RL, Clip L, Stopfen D

0-8250
Minimum quantity 300 pieces
Advertising code barrel MS/L/RL, clip L

0-8250 DOM
Minimum quantity 500 pieces
Advertising code barrel MS/L/RL, clip L, plug D



Farb-Code/Minen
Colour code/Refills

BOOM
0-8450

BOOM M
0-8450 M

271



BOOM

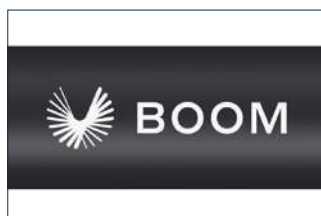

Die Modelle eignen sich für Laserung
in weiß. Siehe Seite 316.

The models are suitable for engraving
in white. See page 316.

0-8450, 0-8450 M* ◇

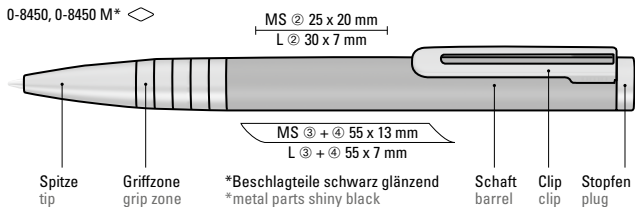

0-8450: Metall-Drehkugelschreiber
mit mattem Gehäuse. Clip, Spitze mit
eingelassener Griffzone und Stopfen
in silber matt.

0-8450: Metal twist ballpoint pen with
matt housing. Clip, tip with recessed grip
zone and plug in matt silver.

0-8450 M: Metall-Drehkugelschreiber
mit mattem Gehäuse. Clip, Spitze mit
eingelassener Griffzone und Stopfen
in schwarz glänzend.

0-8450 M: Metal twist ballpoint pen with
matt housing. Clip, tip with recessed grip
zone and plug in glossy black.

Mindestbestellmenge
Werbeschlüssel

300 Stück
Schaft MS/L

Minimum quantity
Advertising code

300 pieces
barrel MS/L



0-8320 (● 8-0855)



63-0002



● 8-0855

0-8322 R (● 8-0806)



63-0002



● 8-0806

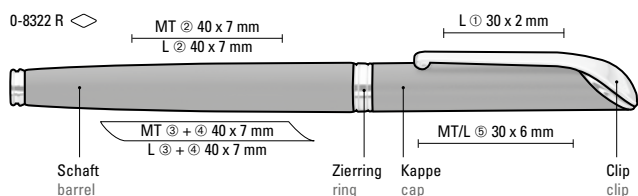
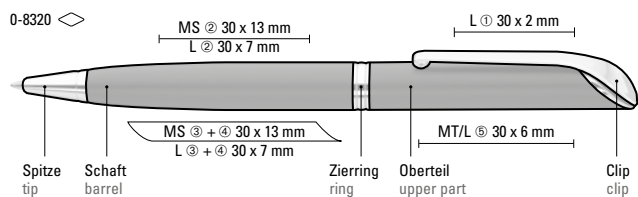

0-8320: Metall-Drehkugelschreiber mit matter Oberfläche. Metallbeschlagteile glanzverchromt.

0-8322 R: Metall-Rollerball mit matter Oberfläche. Metallbeschlagteile glanzverchromt.

0-8320
Mindestbestellmenge 300 Stück
Werbeschlüssel Schaft MS/L,
Clip L, Oberteil MT/L

0-8322 R
Mindestbestellmenge 300 Stück
Werbeschlüssel Schaft MT/L,
Clip L, Kappe MT/L

0-8320: Metal twist ballpoint pen with matt housing. Metal fittings chrome plated.

0-8322 R: Metal rollerball with matt housing. Metal fittings chrome plated.

0-8320
Minimum quantity 300 pieces
Advertising code barrel MS/L,
clip L, upper part MT/L

0-8322 R
Minimum quantity 300 pieces
Advertising code barrel MT/L,
clip L, cap MT/L



0-8340 (● 8-0883)
0-8342 R (● 8-0806)

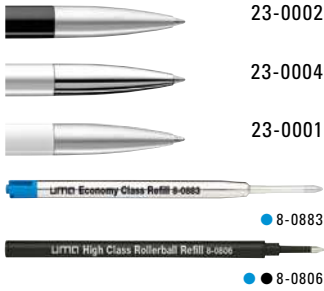

0-8340 TO (● 8-0883)

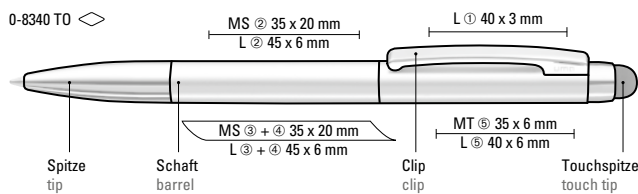
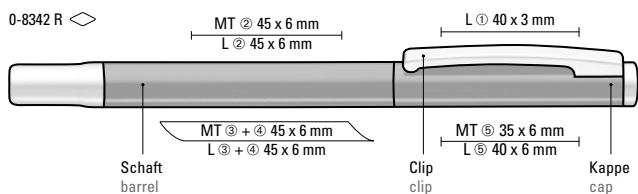
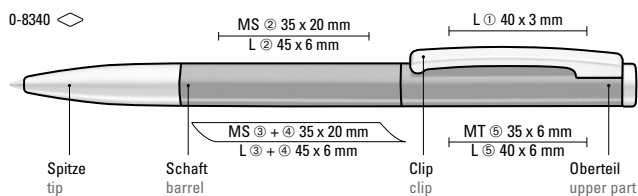

0-8340: Metall-Drehkugelschreiber mit gefedertem Clip. Oberfläche in silber matt mit glänzenden Beschlagteilen oder schwarz bzw. weiß glänzend mit matten Beschlägen.

0-8342 R: Metall-Rollerball mit gefedertem Clip. Oberfläche in silber matt mit glänzenden Beschlagteilen oder schwarz bzw. weiß glänzend mit matten Beschlägen.

0-8340 TO: Metall-Drehkugelschreiber mit gefedertem Clip. Oberfläche in silber matt mit glänzenden Beschlagteilen. Touchfunktion im Oberteil.

0-8340: Metal twist ballpoint pen with spring-mounted clip. Surface in matt silver and glossy chrome fittings, glossy black or white with matt fittings.

0-8342 R: Metal rollerball with spring-mounted clip. Surface in matt silver and glossy chrome fittings, matt black or glossy white with matt fittings.

0-8340 TO: Metal twist ballpoint pen with spring-mounted clip. Surface in matt silver, glossy chrome fittings. Black rubber ball with integrated touch screen control.

0-8340, 0-8340 TO
Mindestbestellmenge 300 Stück
Werbeschlüssel Schaft MS/L,
Clip L, Oberteil MT/L

0-8342 R
Mindestbestellmenge 300 Stück
Werbeschlüssel Schaft MT/L,
Clip L, Kappe MT/L

0-8340, 0-8340 TO
Minimum quantity 300 pieces
Advertising code barrel MS/L,
clip L, upper part MT/L

0-8342 R
Minimum quantity 300 pieces
Advertising code barrel MT/L,
clip L, cap MT/L



0-2622 (● 8-0894)

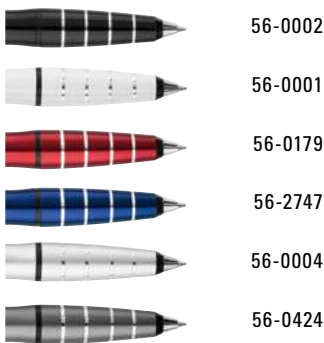

Erhältlich für 0-2622 SET
Available for 0-2622 SET

0-2622 SET (● 8-0894)



Ab 500 Stück kann die Textmarker-Schreibfarbe der Ersatzpatrone im 2in1 SET in den Standardfarben blau, orange, magenta oder grün gegen Aufpreis gewählt werden.

For orders over 500 units, the colour of the replacement refill for the highlighter of the 2in1 SET can be selected for an additional charge among the standard colours blue, orange, magenta or green.

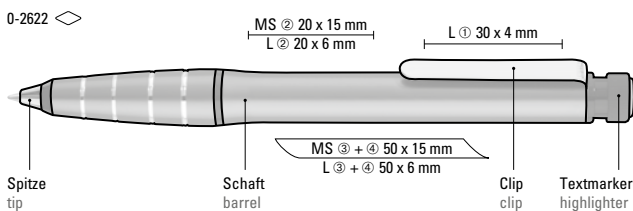

0-2622: Metall-Drehkugelschreiber aus Aluminium mit integriertem gelb schreibenden Textmarker im Schaft. Der Textmarker lässt sich mittels Drehbewegung aus dem Schaft herausnehmen und kann separat genutzt werden.

0-2622: Metal twist ballpoint pen with aluminium housing and integrated yellow writing text marker in the barrel. The highlighter can be twisted out of the barrel and used separately.

0-2622 SET: 2in1-Set - bestehend aus 2in1 Metall-Drehkugelschreiber aus Aluminium mit integriertem gelb schreibenden Textmarker im Schaft, einer Ersatztextmarkerpatrone und einer D1 Mine schwarz-schreibend – im praktischen Etui mit transparentem Kunststoffschuber inkl. Gebrauchsanweisung.

0-2622 SET: 2in1 set - It consists of a 2in1 twist ballpoint pen with aluminium housing and integrated yellow highlighter in the barrel, a replacement highlighter refill and a black D1 refill - in a practical case with transparent plastic slipcase incl. instructions for use.

Mindestbestellmenge 300 Stück
Werbeschlüssel Schaft MS/L, Clip L

Minimum quantity 300 pieces
Advertising code barrel MS/L, clip L



2in1-Besonderheiten:

- zwei Schreibgeräte in einem
- Drehkugelschreiber mit integriertem Textmarker
- Aluminium-Gehäuse mit edler metallic-Lackierung
- stilvolle Griffzone für besten Schreibkomfort
- Trend-Design in sechs Farben
- Tampondruck oder Lasergravur-Veredelung

2in1 special features:

- two writing devices in one
- twist ballpoint pen with integrated text marker
- aluminium housing with noble metallic finish
- stylish grip zone for superb writing comfort
- trend design in six colours
- pad printing or laser engraving finishing



Farb-Code/Minen
Colour code/Refills

SKINNY TOUCH
0-9588 TO

SKINNY M TOUCH
0-9588 M TO

SHORTY S TOUCH
0-2608 S-TO

279

SKINNY TOUCH, SHORTY



Länge: ca. 110 mm
Length: approx. 110 mm



Die Modelle 0-9855 TO und 0-9588 M TO eignen sich für Laserung in weiss. Siehe Seite 317.

The models 0-9855 TO and 0-9588 M TO are suitable for engraving in white. See page 317.

0-9588 TO, 0-9588 M TO* ◊

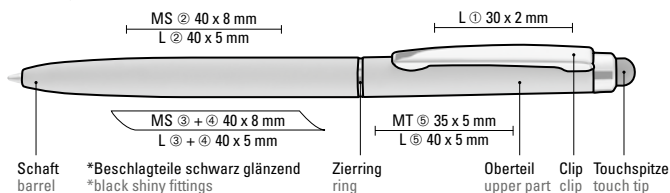

0-2608 S-TO ◊

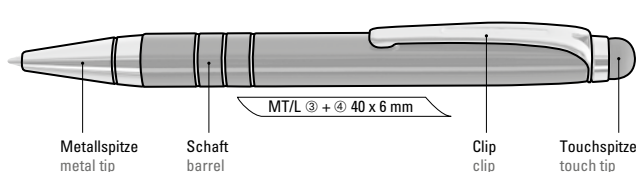

0-9588 TO: Metall-Drehkugelschreiber mit farbig mattem oder weiß glänzendem Gehäuse und silber glänzenden Beschlagenteilen. Gummirtes Schaftende für die Touchscreensteuerung.

0-9588 M TO: Metall-Drehkugelschreiber mit schwarz mattem Gehäuse und schwarz glänzenden Beschlagenteilen. Gummirtes Schaftende für die Touchscreensteuerung.

0-2608 S-TO: Mini Metall-Drehkugelschreiber mit gedeckt glänzendem Gehäuse, Metallzierringe und Beschlagenteile glanzverchromt. Gummierter Oberseite für die Touchscreensteuerung.

0-9588 TO, 0-9588 M TO
Mindestbestellmenge 300 Stück
Werbeschlüssel Schaft MS/L, Clip L, Oberteil MT/L

0-2608 S-TO
Mindestbestellmenge 300 Stück
Werbeschlüssel Schaft MT/L

0-9588 TO: Metal twist ballpoint pen with matt coloured or glossy white housing and silver glossy fittings. Black rubber ball with integrated touch screen control.

0-9588 M TO: Metal twist ballpoint pen with matt black housing and glossy black fittings. Black rubber ball with integrated touch screen control.

0-2608 S-TO: Mini metal twist ballpoint pen with glossy housing, metal clip, metal fittings and metal tip chrome plated. Black rubber ball with integrated touch screen control.

0-9588 TO, 0-9588 M TO
Minimum Quantity 300 pieces
Advertising code barrel MS/L, clip L, upper part MT/L

0-2608 S-TO
Minimum quantity 300 pieces
Advertising code barrel MT/L

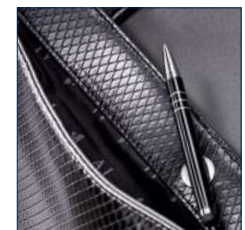

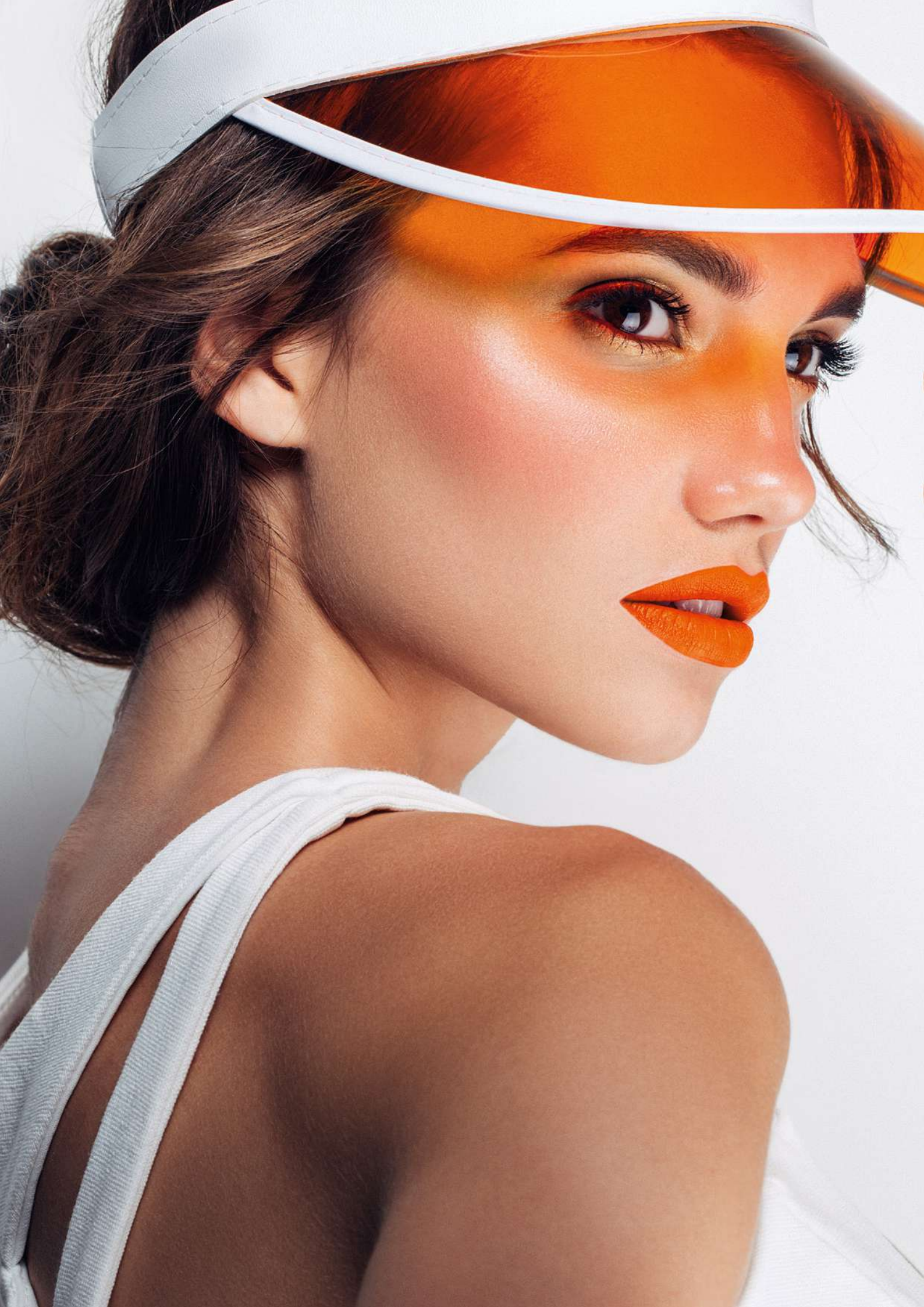

HIGHLIGHTER





uma LIQEO - die Highlighter-Neuheit!

Neues Flüssigtintenleitsystem - Bessere Schreibqualität - Höhere Leuchtkraft -
Längere Schreibdauer - Umweltfreundlicher - Produziert nach EN-71, ASTM D-4236

uma LIQEO - the highlighter novelty!

New liquid ink delivery system - Better writing quality - Greater luminance -
Longer writing time - Ecologically superior - Produced in acc. with EN-71, ASTM D-4236





Kombinieren Sie Ihr Set mit
Ihren Highlighter-Wunschfarben.
Configure your set with your
highlighter colours.



0-0240/4 ◊

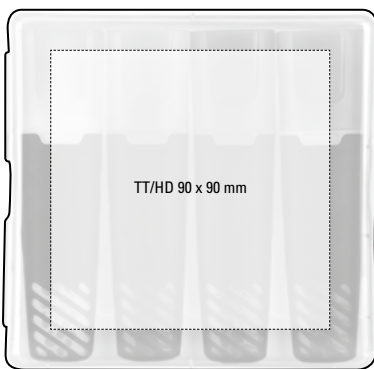

0-0240: Flüssig-Textmarker mit
schwarzem Schaft und transparenter
Kappe in Schreibfarbe. Ohne Pumpen
oder Anstechen sofort einsatzfähig,
umweltfreundlicher, längere
Schreibdauer und höhere Leuchtkraft
als herkömmliche Textmarker.

0-0240/4: Flüssig-Textmarkerset
bestehend aus 4 LIQEO HIGHLIGHTER
in einer klar transparenten
Kunststoffverpackung. Standardfarben
der Textmarker in gelb, grün, magenta
und blau. Optional wählbare
Textmarkerfarben: orange und violett.

0-0240/2 P: Pappfaltschachtel aus
schwarzer Kartonage für 2er Set-Lösung
uma LIQEO HIGHLIGHTER 0-0240.

0-0240/3 P: Pappfaltschachtel aus
schwarzer Kartonage für 3er Set-Lösung
uma LIQEO HIGHLIGHTER 0-0240.

0-0240: Liquid highlighter with black
barrel and transparent cap in writing
colour. Writes longer and more intensive
as conventional highlighter, is without
pumping or tapping operational
immediately, supported in this way the
sustainability concept.

0-0240/4: Liquid highlighter set
consisting of 4 LIQEO HIGHLIGHTERS
in clear transparent plastic packaging.
Standard colours for highlighters are
yellow, green, pink and blue. Optional
colours orange and purple can be
chosen.

0-0240/2 P: Cardboard case in black for
2 uma LIQEO HIGHLIGHTER 0-0240.

0-0240/3 P: Cardboard case in black for 3
uma LIQEO HIGHLIGHTER 0-0240.

0-0240/2 P ◊

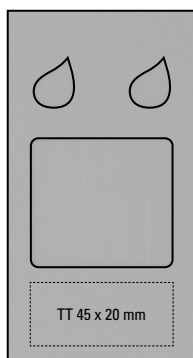

0-0240/3 P ◊

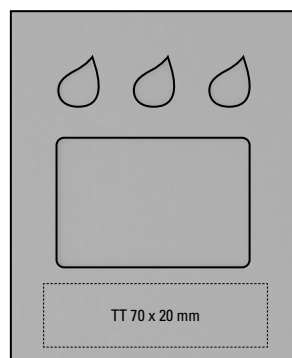

0-0240	Mindestbestellmenge	500 Stück
	Werbeschlüssel	Schaft P, Kappe P
0-0240/4	Mindestbestellmenge	300 Stück
	Werbeschlüssel	Highlighter P, Etuis TT/HD
0-0240/2 P, 0-240/3 P	Mindestbestellmenge	300 Stück
	Werbeschlüssel	Etui TT

0-0240	Minimum quantity	500 pieces
	Advertising code	barrel P, cap P
0-0240/4	Minimum quantity	300 pieces
	Advertising code	highlighter P, cases TT/HD
0-0240/2 P, 0-0240/3 P	Minimum quantity	300 pieces
	Advertising code	cases TT

LIQEO HIGHLIGHTER MINI
0-0250

LIQEO HIGHLIGHTER MINI 4er SET
0-0250/4

Farb-Code/Minen
Colour code/Refills



0-0250

50-0801

50-0802

50-0930

50-0814

50-0806

50-0804



Kombinieren Sie Ihr Set mit
Ihren Highlighter-Wunschfarben.
Configure your set with your
highlighter colours.

uma LIQEO - die Highlighter-Neuheit!

Neues Flüssigtintenleitsystem - Bessere Schreibqualität -

Höhere Leuchtkraft - Längere Schreibdauer -

Umweltfreundlicher - Produziert nach EN-71, ASTM D-4236

uma LIQEO - the highlighter novelty!

New liquid ink delivery system - Better writing quality -

Greater luminance - Longer writing time - Ecologically

superior - Produced in acc. with EN-71, ASTM D-4236



0-0250: Flüssig-Textmarker MINI mit schwarzem Schaft und transparenter Kappe in Schreibfarbe. Ohne Pumpen oder Anstechen sofort einsatzfähig, umweltfreundlicher, längere Schreibdauer und höhere Leuchtkraft als herkömmliche Textmarker.

0-0250/4: Flüssig-Textmarkerset bestehend aus 4 LIQEO HIGHLIGHTER MINI in einer klar transparenten Kunststoffverpackung. Standardfarben der Textmarker in gelb, grün, magenta und blau. Optional wählbare Textmarkerfarben: orange und violett.

0-0250
Mindestbestellmenge 500 Stück
Werbeschlüssel Schaft P, Kappe P

0-0250/4
Mindestbestellmenge 300 Stück
Werbeschlüssel Highlighter P, Etais TT/HD

0-0250: Liquid highlighter MINI with black barrel and transparent cap in writing colour. Writes longer and more intensive as conventional highlighter, is without pumping or tapping operational immediately, supported in this way the sustainability concept.

0-0250/4: Liquid highlighter set consisting of 4 LIQEO HIGHLIGHTERS MINI in clear transparent plastic packaging. Standard colours for highlighters are yellow, green, pink and blue. Optional colours orange and purple can be chosen.

0-0250
Minimum quantity 500 pieces
Advertising code barrel P, cap P

0-0250/4
Minimum quantity 300 pieces
Advertising code highlighter P, cases TT/HD

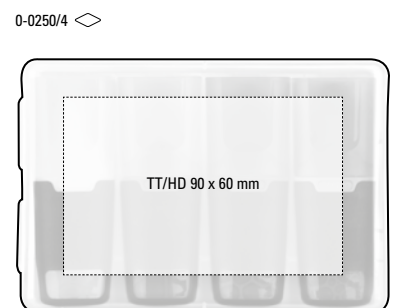
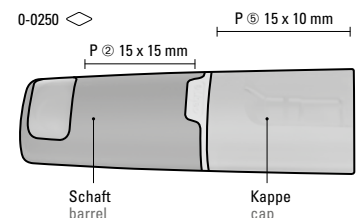

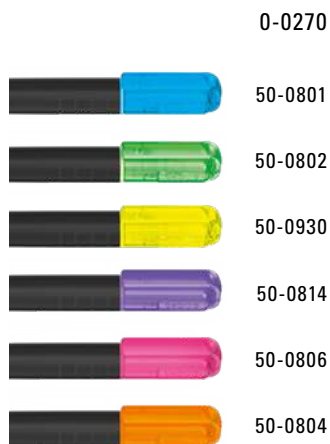

Kombinieren Sie Ihr Set mit Ihren Highlighter-Wunschfarben.
Configure your set with your highlighter colours.

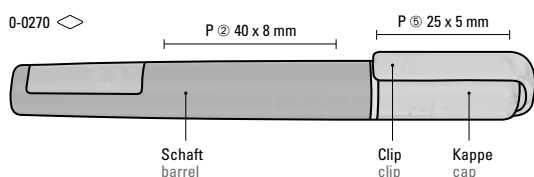

0-0270/4 ◊

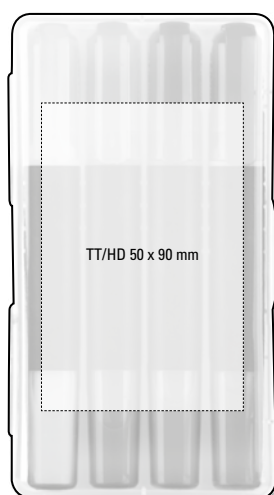

0-0270: Flüssig-Textmarker in Stiftform mit schwarzem Schaft und transparenter Kappe in Schreibfarbe. Ohne Pumpen oder Anstechen sofort einsatzfähig, umweltfreundlicher, längere Schreibdauer und höhere Leuchtkraft als herkömmliche Textmarker.

0-0270/4: Flüssig-Textmarkerset bestehend aus 4 LIQEO HIGHLIGHTER PEN in einer klar transparenten Kunststoffverpackung. Standardfarben der Textmarker in gelb, grün, magenta und blau. Optional wählbare Textmarkerfarben: orange und violett.

0-0270
Mindestbestellmenge 500 Stück
Werbeschlüssel Schaft P, Kappe P
0-0270/4
Mindestbestellmenge 300 Stück
Werbeschlüssel Highlighter P, Etuis TT/HD

0-0270: Liquid highlighter pen-shaped with black barrel and transparent cap in writing colour. Writes longer and more intensive as conventional highlighter, is without pumping or tapping operational immediately, supported in this way the sustainability concept.

0-0270/4: Liquid highlighter set consisting of 4 LIQEO HIGHLIGHTERS PEN in clear transparent plastic packaging. Standard colours for highlighters are yellow, green, pink and blue. Optional colours orange and purple can be chosen.

0-0270
Minimum quantity 500 pieces
Advertising code barrel P, cap P
0-0270/4
Minimum quantity 300 pieces
Advertising code highlighter P, cases TT/HD







Schreiben und Markieren -
endlich vereint, was zusammengehört.

Write and Highlight -
brings together what belongs together.

0-0915, 0-0915/2 ◊

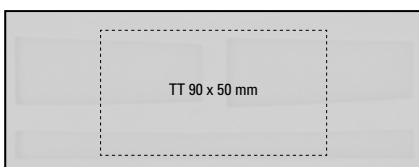

0-0915: Etui mit EVA-Einlage für ein Schreibgerät nach Wahl und ein LIQEO HIGHLIGHTER (0-0240) mit transparent gefrostetem Kunststoffschuber.

0-0915 CI: Etui mit EVA-Einlage für ein Schreibgerät nach Wahl und ein LIQEO HIGHLIGHTER (0-0240) mit individuell gestaltbarem Kartonschuber.

0-0915/2: Etui mit EVA-Einlage für ein Schreibgerät nach Wahl und zwei LIQEO HIGHLIGHTER MINI (0-0250) mit transparent gefrostetem Kunststoffschuber.

0-0915/2 CI: Etui mit EVA-Einlage für ein Schreibgerät nach Wahl und zwei LIQEO HIGHLIGHTER MINI (0-0250) mit individuell gestaltbarem Kartonschuber.

0-0915: Case with EVA inlay for one writing instrument of your own choice and one LIQEO HIGHLIGHTER (0-0240) with transparent frosted plastic slipcase.

0-0915 CI: Case with EVA inlay for one writing instrument of your own choice and one LIQEO HIGHLIGHTER (0-0240) with individual cardboard slipcase.

0-0915/2: Case with EVA inlay for one writing instrument of your own choice and two LIQEO HIGHLIGHTER MINI (0-0250) with transparent frosted plastic slipcase.

0-0915/2 CI: Case with EVA inlay for one writing instrument of your own choice and two LIQEO HIGHLIGHTER MINI (0-0250) with individual cardboard slipcase.

0-0915, 0-0915/2 Mindestbestellmenge Werbeschlüssel	500 Stück TT	0-0915, 0-0915/2 Minimum quantity Advertising code	500 pieces TT
0-0915 CI, 0-0915/2 CI Mindestbestellmenge Werbeschlüssel	500 Stück individuell	0-0915 CI, 0-0915/2 CI Minimum quantity Advertising code	500 pieces individual

**TEXTMARKER
HIGHLIGHTER
0-0200**

**TEXTMARKER 2ER SET
HIGHLIGHTER SET OF 2
0-0200/2**

**BESCHREIBUNG
DESCRIPTION**

0-0200: Textmarker mit Kunststoffgehäuse, Kappe und Clip in weiß. Mundstück mit Zierring und Stopfen in der Schreibfarbe. Standardfarben gelb, grün, magenta.

0-0200/2: Textmarker 2er-Set aus den Standardfarben in transparentem Stecketui.

0-0200
Mindestbestellmenge 500 Stück
Werbeschlüssel Schaft P, Clip P

0-0200/2
Mindestbestellmenge 300 Stück
Werbeschlüssel Schaft P, Clip P

0-0200: Highlighter with plastic housing, cap and clip in white. Section with ring and plug in writing colour. Standard colours are yellow, green, magenta.

0-0200/2: Highlighter set of 2 from the standard colours in transparent slip in case.

0-0200
Minimum quantity 500 pieces
Advertising code barrel P, clip P

0-0200/2
Minimum quantity 300 pieces
Advertising code barrel P, clip P

0-0200 ◊

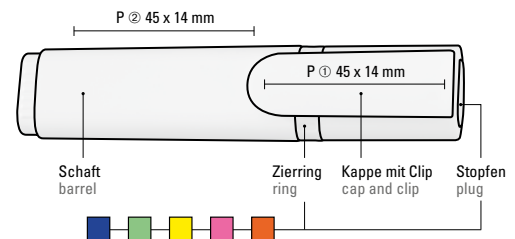
**TEXTMARKER SET
HIGHLIGHTER SET
0-0200/3**

Modell auf Anfrage auch mit blauem oder orangenem Textmarker.

On request the item is available with blue and orange highlighter.

**BESCHREIBUNG
DESCRIPTION**

0-0200/3: Set-Box in Köcherform mit 3 Textmarkern (0-0200) in verschiedenen Schreibfarben (gelb/grün/magenta). Auch mit Klebebänderole erhältlich – Preis auf Anfrage.

Mindestbestellmenge 300 Stück
Werbeschlüssel Schaft P, Clip P, Box TT

0-0200/3: Set box in quiver form with 3 highlighters (0-0200) in different writing colours (yellow/green/magenta). Also available with adhesive sleeve – price on request.

Minimum quantity 300 pieces
Advertising code barrel P, clip P, box TT

**Farb-Code (Schreibfarben)
Colour code (Ink colours)**

0-0200

50-0225

50-7481

50-0809

50-1575

50-2915

0-0200/3 ◊

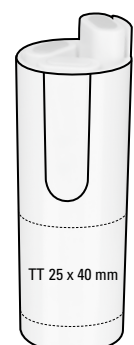



Farb-Code (Schreibfarben)
Colour code (Ink colours)

0-0200	
50-0225	
50-7481	
50-0809	
50-1575	
50-2915	

Modell auf Anfrage auch mit blauem oder orangenem Textmarker.

On request the item is available with blue and orange highlighter.

BESCHREIBUNG
DESCRIPTION

0-0230/3: Textmarkerständer für 3 Textmarker (0-0200) mit großer Werbefläche. Standard Textmarker-Schreibfarbe magenta, gelb, grün.

0-0230/3
Mindestbestellmenge 300 Stück
Werbeschlüssel TT, HD auf Werbeplatte, Schaft P, Clip P

0-0230/3: Highlighter rack for 3 highlighters (0-0200) with a big advertising space. Standard highlighter writing colour yellow, green and magenta.

0-0230/3
Minimum quantity 300 pieces
Advertising code TT, HD on panel barrel P, clip P

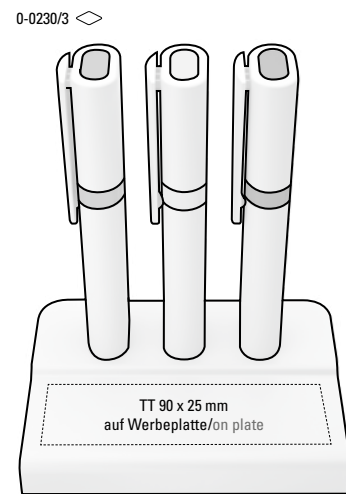

TEXTMARKER SET SI
HIGHLIGHTER SET SI
0-0200/3 SI



Modell auf Anfrage auch mit blauem oder orangenem Textmarker.

On request the item is available with blue and orange highlighter.



BESCHREIBUNG
DESCRIPTION

0-0200/3 SI: Silberne Set-Box in Köcherform mit 3 Textmarkern (0-0200) in verschiedenen Schreibfarben (gelb/grün/magenta). Auch mit Klebebänderole erhältlich – Preis auf Anfrage

Mindestbestellmenge 300 Stück
Werbeschlüssel Schaft P, Clip P, Box TT

0-0200/3 SI: Silver set box in quiver form with 3 highlighters (0-0200) in different writing colours (yellow/green/magenta). Also available with adhesive sleeve – price on request.

Minimum quantity 300 pieces
Advertising code barrel P, clip P, box TT

Farb-Code (Schreibfarben)
Colour code (Ink colours)

0-0200	
50-0225	
50-7481	
50-0809	
50-1575	
50-2915	

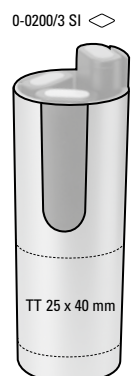





ZUBEHÖR
ACCESSOIRES





9-0500 ◊

9-0500: Notizbuch mit Hardcover aus PU-Material A5 210 x 130mm in schwarz oder weiß mit integriertem farbigem Notizschreiber (1.000m). Runde Ecken, 6mm Elastikverschlussband, Satin-Lesezeichen und Stifteschleufe. Visitenkartenfach und Einstecktasche. 190 Notizseiten aus 80g/m² weißem Papier 1/1-farbig bedruckt, alle Seiten druckgleich kariert.

Mindestbestellmenge 100 Stück
Werbeschlüssel Buch HD/TT
Schreibgerät T/HD

9-0500: Notebook with hardcover made from PU-material A5 210 x 130mm, black or white with integrated coloured pen (1.000m). Round corners, elastic strap (6mm), satin bookmark and penholder. Business card pocket and insert pocket. 190 white pages, squared, 1/1 printed (80g).

Minimum quantity 100 pieces
Advertising code Book HD/TT
ballpoint pen T/HD

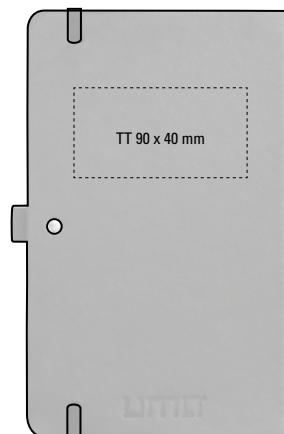

Rückseite/Backside

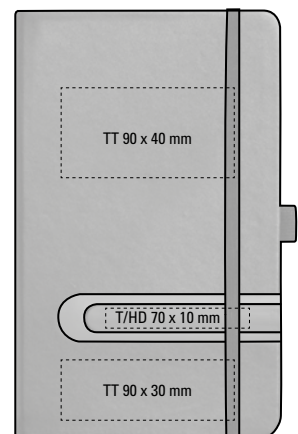

Vorderseite/Frontside

DESK KE
0-0506 KE

DESK LUX KE
0-0506 LUX-KE

BESCHREIBUNG
DESCRIPTION



0-0506 KE: Kugelschreiberständer in gedeckten Farben mit passendem Kugelschreiber Modell TURBO an Metallkette (50cm). Geliefert in praktischer Präsentverpackung.

0-0506 LUX-KE: Kugelschreiberständer in silber mit passendem Kugelschreiber Modell TURBO an Metallkette (50cm). Geliefert in praktischer Präsentverpackung.

Mindestbestellmenge 300 Stück
Werbeschlüssel TT, HD auf Werbeplatte

0-0506 KE: Ballpoint pen rack in opaque colours with suitable ballpen TURBO with metal chain (50cm). Supplied in a convenient present box.

0-0506 LUX-KE: Ballpoint pen rack in silver with suitable ballpen TURBO with metal chain (50cm). Supplied in a convenient present box.

Minimum quantity 300 pieces
Advertising code TT, HD on panel

0-0506 KE, 0-0506 LUX KE ◊



Farb-Code (Minen)
Colour code (Refills)

0-0506 KE
0-0506 LUX-KE

- 50-0002
- 50-0001
- 50-0004



OFFICE KE
1-0504 KE

OFFICE TE
1-0504 TE

BESCHREIBUNG
DESCRIPTION



1-0504 KE: Stiftständer mit Kugelschreiber an einer Metallkette und großer Werbeplatte.

1-0504 TE: Stiftständer mit Kugelschreiber an einer Kunststoffspirale und großer Werbeplatte.

Mindestbestellmenge 300 Stück
Werbeschlüssel Schaft S, TT auf Werbeplatte

1-0504 KE: Pen rack ballpoint pen on a metal chain and with large advertising plate.

1-0504 TE: Pen rack ballpoint pen on a plastic spiral and with large advertising plate.

Minimum quantity 300 pieces
Advertising code barrel S, TT on panel

1-0504 TE, 1-0504 KE ◊

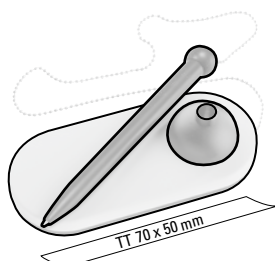

Farb-Code (Minen)
Colour code (Refills)

1-0504 KE (● 8-0855)
1-0504 TE (● 8-0855)

- | Werbeplatte
advertising plate | Boden & Kugel
ground & ball |
|--|---|
| 01-0287 | |
| 01-1805 | |
| 01-0002 | |
| 01-0003 | |
| 01-0108 | |



HAFTKLAMMER
ADHESIVE WALL CLIP
9-0447 TE



BESCHREIBUNG
DESCRIPTION

9-0447 TE: Haftklammer mit Kugelschreiber an einer Kunststoffspirale in schwarz oder weiß. Doppelkleber am Haftklammerboden.

Mindestbestellmenge 500 Stück
Werbeschlüssel TT auf Werbeplatte

9-0447 TE: Adhesive wall clip with ballpoint pen on a plastic spiral in black or white. Clip base features a two-sided adhesive.

Minimum quantity 500 pieces
Advertising code TT on panel

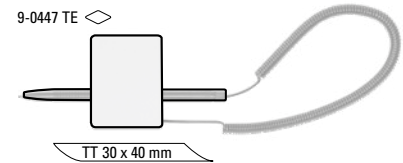

QUATER
0-0901



TRANSPARENTES KUNSTSTOFFETUI
TRANSPARENT PLASTIC CASE
0-0934



Beispiel ARCTIS-SET
Example ARCTIS-SET

BESCHREIBUNG
DESCRIPTION

0-0901: Transparentes Kunststoff Etui mit Halterung aus Kunststoff. Der Kugelschreiber wird schwebend im Etui fixiert.

0-0934: Klar transparentes Kunststoff Klappetui für ein oder zwei Schreibgeräte.

Werbeschlüssel TT
Mindestbestellmenge 100 Stück

0-0901: Transparent plastic case with plastic holding ring. The ballpoint pen is fixed floating in the case.

0-0934: Plastic hinged case in clear transparent for one or two writing instruments.

Advertising code TT
Minimum quantity 100 pieces

0-0901 ◊

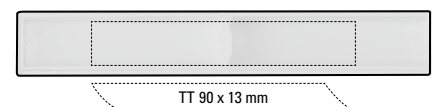

0-0934 ◊

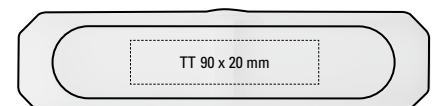

TUBE
0-0909 P

BESCHREIBUNG
DESCRIPTION

295



0-0909 P ◊



0-0909 P: Pappröhrenetui mit abnehmbarem Deckel in matt schwarz.
Mindestbestellmenge 100 Stück
Werbeschlüssel Schaft TT, Kappe TT
0-09090 P: Cardboard tube case with removable lid in matt black.
Minimum quantity 100 pieces
Advertising code barrel TT, cap TT

TUBE, SQUARE

SQUARE
0-0943

BESCHREIBUNG
DESCRIPTION



0-0943 ◊

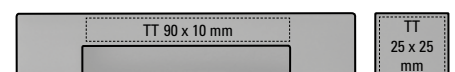

0-0943: Pappstecketui in schwarz mit offenem Sichtfenster auf das Schreibgerät.
Mindestbestellmenge 100 Stück
Werbeschlüssel TT
0-0943: Cardboard case in black with open window to see the writing instrument.
Minimum quantity 100 pieces
Advertising code TT

PAPPSTECKETUI
CARDBOARD SLIP-IN CASE
0-0940

PAPPSTECKETUI RECY
CARDBOARD SLIP-IN CASE RECY
0-0940 RECY

BESCHREIBUNG
DESCRIPTION



0-0940: Pappstecketui in schwarz oder weiß für ein Schreibgerät. Auch erhältlich mit dem Standardaufdruck: „Mit freundlicher Empfehlung – With compliments“.

0-0940 RECY: Pappstecketui aus Naturkarton für ein Schreibgerät, mit aufgedrucktem Recycling Hinweis auf der Rückseite. Farbschwankungen aufgrund des Recyclingprozesses gegeben.

Mindestbestellmenge 100 Stück
 Werbeschlüssel TT

0-0940: Cardboard slip-in case in black or white for one writing instrument without imprint or with the standard message: "Mit freundlicher Empfehlung – With compliments".

0-0940 RECY: Natural cardboard case for one writing instrument, with printed recycling information on the back. Colour variations may occur due to the recycling process.

Minimum quantity 100 pieces
 Advertising code TT

PAPPSTECKETUI CI
CARDBOARD SLIP-IN CASE CI
0-0940 CI

PAPPSTECKETUI CI rPET
CARDBOARD SLIP-IN CASE CI rPET
0-0940 CI rPET

BESCHREIBUNG
DESCRIPTION



0-0940 CI: Pappstecketui für ein Schreibgerät mit individuellem CI-Aufdruck.

0-0940 CI rPET: Pappstecketui aus FSC®-zertifiziertem Pappkarton für ein Schreibgerät mit aufgedruckter Erklärung zur uma RECYCLED PET PEN Serie.

0-0940 CI
 Mindestbestellmenge 500 Stück
 Werbeschlüssel individuell

0-0940 CI rPET
 Mindestbestellmenge 100 Stück
 Werbeschlüssel TT

0-0940 CI: Cardboard slip-in case for one writing instrument with individual CI-imprint.

0-0940 CI rPET: Cardboard slip-in case made of FSC® certified cardboard for one writing instrument with printed declaration of uma RECYCLED PET PEN serie.

0-0940 CI
 Minimum quantity 500 pieces
 Advertising code individual

0-0940 CI rPET
 Minimum quantity 100 pieces
 Advertising code TT

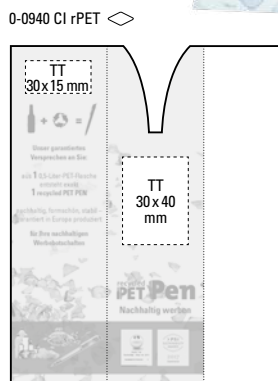
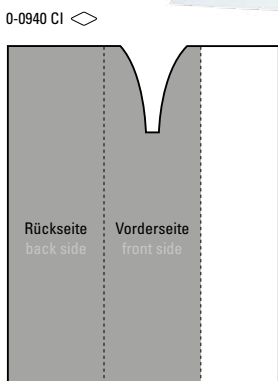

PAPPSTECKETUI antibacterial
 CARDBOARD SLIP-IN CASE antibacterial
 0-0940 CI ANTIBAC

PAPPSTECKETUI CI GREEN
 CARDBOARD SLIP-IN CASE GREEN
 0-0940 CI GREEN

BESCHREIBUNG
 DESCRIPTION



0-0940 CI ANTIBAC: Pappstecketui aus FSC®-zertifiziertem Pappkarton für ein Schreibgerät mit aufgedruckter Erklärung zum uma RECYCLED PET PEN PRO antibacterial.

0-0940 CI GREEN: Pappstecketui aus FSC®-zertifiziertem Pappkarton für ein Schreibgerät mit aufgedruckter Erklärung zur uma antibacterial GREEN Serie.

Mindestbestellmenge 100 Stück

0-0940 CI ANTIBAC: Cardboard slip-in case made of FSC® certified cardboard for one writing instrument with printed declaration of uma RECYCLED PET PEN PRO antibacterial.

0-0940 CI GREEN: Cardboard slip-in case made of FSC® certified cardboard for one writing instrument with printed declaration of uma antibacterial GREEN serie.

Minimum quantity 100 pieces

PAPPSTECKETUI
 CARDBOARD SLIP-IN CASE
 0-0942

ETUI rPET
 0-0955 rPET

BESCHREIBUNG
 DESCRIPTION



0-0955 rPET ◊

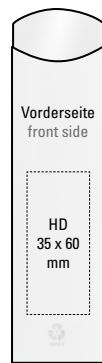

0-0942 ◊

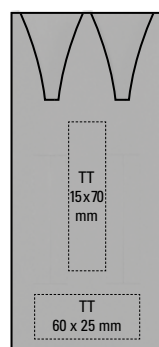

0-0942: Pappstecketui in schwarz für zwei Schreibgeräte mit Stanzung.

0-0955 rPET: Etui aus recyceltem PET Material für ein oder zwei Schreibgeräte.

0-0942
 Mindestbestellmenge 100 Stück
 Werbeschlüssel TT

0-0955 rPET
 Mindestbestellmenge 100 Stück
 Werbeschlüssel HD

0-0942: Cardboard slip-in case in black for two writing instruments with punching.

0-0955 rPET: Case made of recycled rPET material for one or two writing instruments.

0-0942
 Minimum quantity 100 pieces
 Advertising code TT

0-0955 rPET
 Minimum quantity 100 pieces
 Advertising code HD

ETUI
0-0914/2

ETUI CI
0-0914/2 CI

BESCHREIBUNG
DESCRIPTION

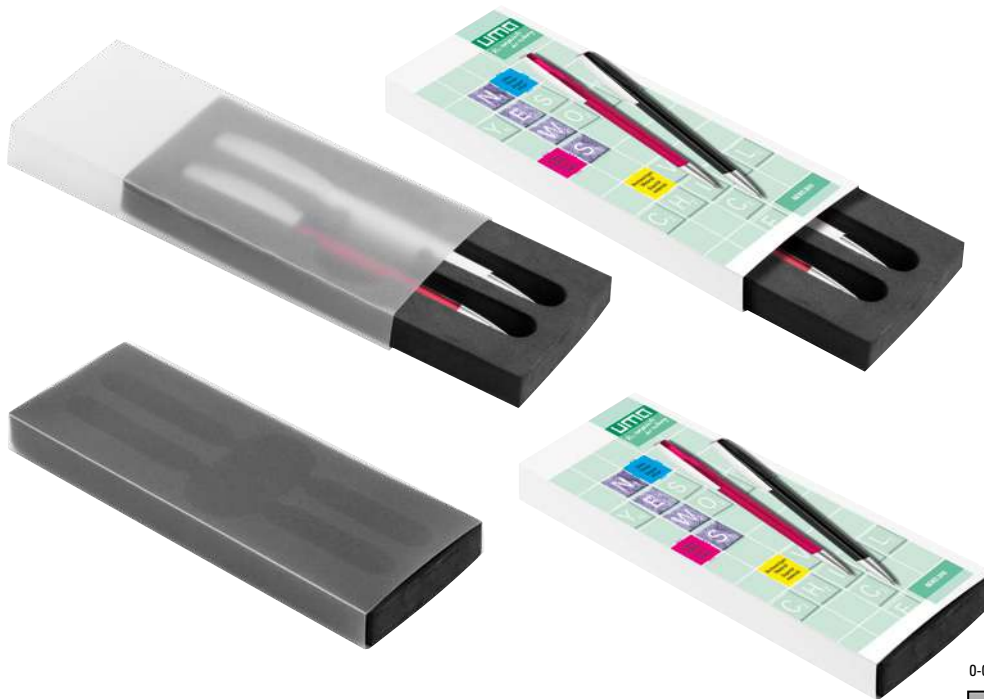

0-0914/2: Etui mit EVA-Einlage für 2 Schreibgeräte mit transparent gefrostetem Kunststoffschuber.

0-0914/2 CI: Etui mit EVA-Einlage für 2 Schreibgeräte mit individuell gestaltbarem Kartonschuber.

0-0914/2
Mindestbestellmenge 100 Stück
Werbeschlüssel TT

0-0914/2 CI
Mindestbestellmenge 500 Stück
Werbeschlüssel individuell

0-0914/2: Case with EVA inlay for two writing instruments with transparent frosted plastic slipcase.

0-0914/2 CI: Case with EVA inlay for two writing instruments with individual cardboard slipcase.

0-0914/2
Minimum quantity 100 pieces
Advertising code TT

0-0914/2 CI
Minimum quantity 500 pieces
Advertising code individual

0-0914/2 ◊

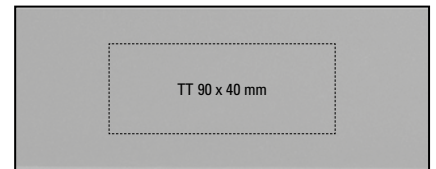

ETUI
0-0914

ETUI CI
0-0914 CI

BESCHREIBUNG
DESCRIPTION



0-0914: Etui mit EVA-Einlage für 1 Schreibgerät mit transparent gefrostetem Kunststoffschuber.

0-0914 CI: Etui mit EVA-Einlage für 1 Schreibgerät mit individuell gestaltbarem Kartonschuber.

0-0914
Mindestbestellmenge 100 Stück
Werbeschlüssel TT

0-0914 CI
Mindestbestellmenge 500 Stück
Werbeschlüssel individuell

0-0914: Case with EVA inlay for 1 writing instrument with transparent frosted plastic slipcase.

0-0914 CI: Case with EVA inlay for one writing instrument with individual cardboard slipcase.

0-0914
Minimum quantity 100 pieces
Advertising code TT

0-0914 CI
Minimum quantity 500 pieces
Advertising code individual

0-0914 ◊

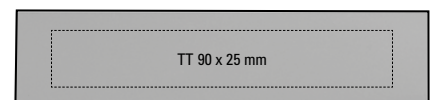

CASE
0-0918

BESCHREIBUNG
DESCRIPTION

299

CASE, BOX



0-0918: Zweiteiliges, schweres Pappetui in schwarz mit abnehmbarem Deckel, eingelassener Ziernaht in schwarz, schwarz glitzernd oder silber glitzernd, Kisseneinlage für ein oder zwei Schreibgeräte.

Mindestbestellmenge 100 Stück
Werbeschlüssel TT/HD

0-0918: Two-piece, heavy cardboard case in black with removable lid, decorative stitching in glossy black, black glittering or silver glittering and pillow inlay for one or two writing instruments.

Minimum quantity 100 pieces
Advertising code TT/HD



0-0918 ◊

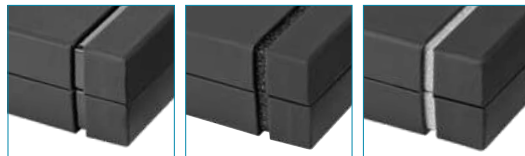
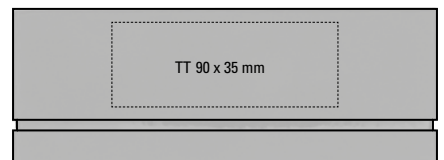

53-000B
black

53-00GB
glitter black

53-00GS
glitter silver

BOX
0-0944

BESCHREIBUNG
DESCRIPTION



0-0944: Zweiteiliges Pappetui mit abnehmbarem Deckel und W-Einlage für ein oder zwei Schreibgeräte.

Mindestbestellmenge 100 Stück
Werbeschlüssel TT/HD/RD

0-0944: Two-piece cardboard case with removable lid and W-inlay for one or two writing instruments.

Minimum quantity 100 pieces
Advertising code TT/HD/RD



0-0944 ◊

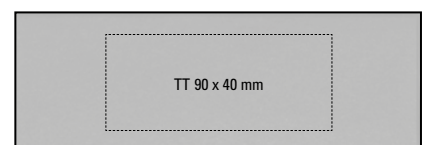

ETUI
0-0911ETUI
0-0911 WBESCHREIBUNG
DESCRIPTION

0-0911: Klappetui im Carbonfaser-Look mit Magnetverschluss für ein oder zwei Schreibgeräte. Kartonschuber im Carbonfaser-Look. Auf Anfrage ist der Kartonschuber mit 4c-Gestaltung erhältlich.

0-0911 W: Klappetui in uni weiß oder schwarz mit Magnetverschluss für ein oder zwei Schreibgeräte. Kartonschuber in weiß.

Auf Anfrage ist der Kartonschuber mit 4c-Gestaltung erhältlich.

0-0911
Mindestmenge 100 Stück
Werbeschlüssel TT/HD

0-0911 W
Mindestmenge 100 Stück
Werbeschlüssel TT/HD/RD

0-0911: Hinged case with magnetic closure in carbon fibre look for one or two writing instruments. Cardboard slipcase in carbon fibre look.

On request the cardboard slipcase is available in a 4c-design.

0-0911 W: Hinged case with magnetic closure in white or black for one or two writing instruments. Cardboard slipcase in white.

On request, the cardboard slipcase is available with a 4c-design.

0-0911
Minimum quantity 100 pieces
Advertising code TT/HD

0-0911 W
Minimum quantity 100 pieces
Advertising code TT/HD/RD

0-0911 W ◊

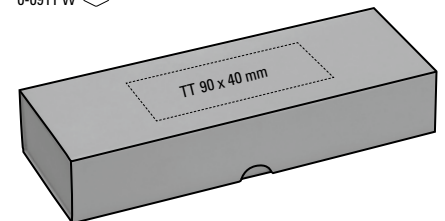
BESCHREIBUNG
DESCRIPTION

0-0917: Klappetui mit Magnetverschluss in schwarz für ein oder zwei Schreibgeräte.

Mindestbestellmenge 100 Stück
Werbeschlüssel TT

0-0917: Hinged case with magnetic closure in black for one or two writing instruments.

Minimum quantity 100 pieces
Advertising code TT

0-0917 ◊

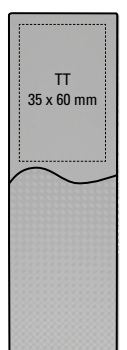
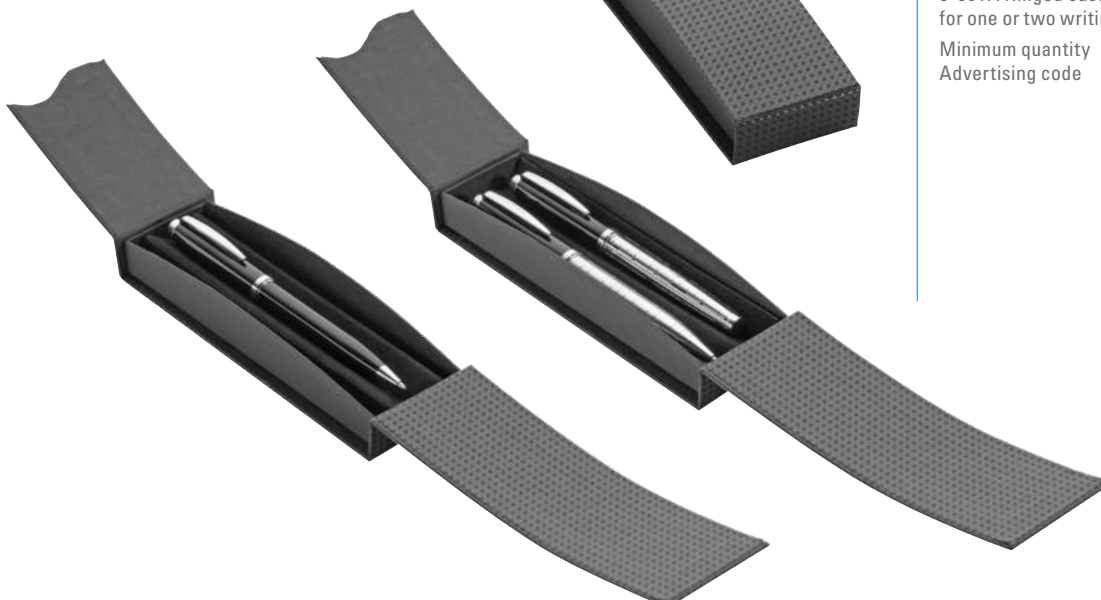
ETUI
0-0917

METALLETUI
0-0962 M

METALLETUI ML
0-0962 ML

BESCHREIBUNG
DESCRIPTION

301



0-0962 M: Metall-Klappetui in silber für ein oder zwei Schreibgeräte.

0-0962 ML: Metall-Klappetui für ein oder zwei Schreibgeräte mit lackierter Oberfläche in schwarz oder weiß.

Mindestbestellmenge 100 Stück
Werbeschlüssel MT/L

0-0962 M: Metal hinged case in silver for one or two writing instruments.

0-0962 ML: Metal hinged case lacquered in black or white for one or two writing instruments.

Minimum quantity 100 pieces
Advertising code MT/L

0-0962 M, 0-0962 ML ◊

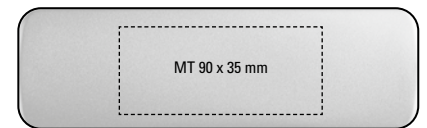

LEDERETUI
0-0900 LE

BESCHREIBUNG
DESCRIPTION



0-0900 LE: Schwarzes Lederetui für ein oder zwei Schreibgeräte mit silberfarbener Metalleiste.

Mindestbestellmenge 100 Stück
Werbeschlüssel TT

0-0900 LE: Black leather case for one or two writing instruments with silver-coloured metal strip.

Minimum quantity 100 pieces
Advertising code TT

0-0900 LE ◊



ETUIS



MINEN

REFILLS

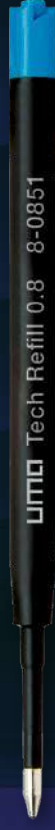

Die uma Qualitätsminen – lieber schreiben, besser werben

The uma quality refill – better write, better promote

uma Minen – Qualität auf ganzer Linie

Die uma Qualitätsmine – das Herzstück jedes uma Schreibgerätes und somit auch einer der wichtigsten Gründe für nachhaltig erfolgreiche Werbekampagnen. uma steht für langanhaltenden Schreibgenuss und Minen, denen nicht so schnell die Puste ausgeht: Aus diesem Grund legen wir allergrößten Wert auf höchste Qualität – und gehen hier auch keine Kompromisse ein. Dank dem Einsatz deutscher Paste und Einhaltung der ISO NORM 12757-2 versprechen die uma Qualitätsminen ein unvergessliches Schreiberlebnis, besten Schreibkomfort und Dokumentenechtheit auf ganzer Linie.

uma refill – Quality all along the line

The uma quality refill – the heart of every uma writing instrument and thus one of the most important reasons for lastingly successful advertising messages. uma stands for long-lasting writing pleasure and refills that don't run out of ink so quickly: For this reason, we place the utmost importance on top quality – and we don't make any compromises here. Thanks to the use of German paste and compliance with ISO NORM 12757-2, uma quality leads promise an unforgettable writing experience, the best writing comfort and document authenticity across the board.



Jede Handschrift zeichnet sich durch ihr individuelles Schriftbild aus. Ähnlich halten wir es auch mit der uma Mine. Je nach Wunsch finden Sie in unserem umfangreichen Minensortiment die beste Minenschreibtechnik für verschiedenste Schreibeigenschaften, passend zu unseren Modellvarianten. Aber ganz gleich ob mit Kugelschreiber-, Rollerballmine oder Patronen-Roller-System oder dem innovativen uma Tintenleitsystem – mit einer uma Mine schreiben Sie mit Sicherheit Qualität auf ganzer Linie.

Each handwriting is characterised by its individual typeface. We have a similar approach with the uma refill. Depending on your wishes, you will find the best refill writing technique for the most diverse writing characteristics in our extensive range of refills, matching our model variants. But no matter whether you use a biro refill, rollerball refill or cartridge rollerball system or the innovative uma ink feed system – with an uma refill you are sure to write quality all along the line.

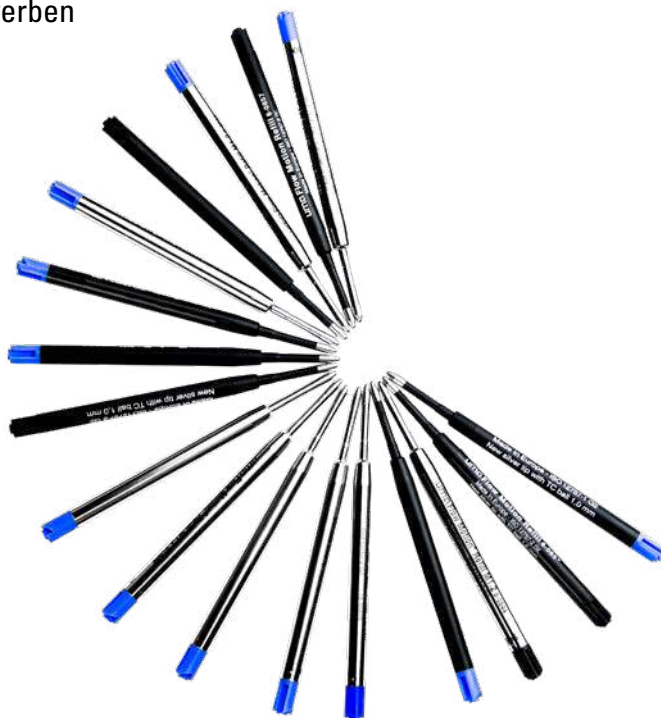

uma Qualitätsminen – Dokumental® inside!

Allen die eine uma Qualitätsmine schreiben garantieren wir Dokumental® inside. In Zusammenarbeit mit dem deutschen Pasten-Spezialisten Dokumental® fertigen wir eine Kombination aus feinsten Minentechnologie und bester Schreibpaste. Nur ein optimales Zusammenspiel aller Minenbauteile, ergibt das einzigartige uma Schreibgefühl. Alle Pasten und Minen entsprechen so nicht nur den REACH-Vorgaben sondern überzeugen auch in Strichfarbe, Strichstärke und Schreiblänge.

uma quality refills – Dokumental® inside!

We guarantee Dokumental® inside to all those who write an uma quality magazine. In cooperation with the German paste specialist Dokumental®, we produce a combination of the finest lead technology and the best writing paste. Only an optimal interaction of all lead components results in the unique uma writing experience. All pastes and leads not only comply with the REACH regulations, but also convince in line colour, line width and writing length.



uma Tech®

uma Tech® – unsere bewährte Qualitätsmine

Unsere uma Tech® Minen gelten seit langem als bewährte Wahl, wenn es um qualitativ hochwertiges und langanhaltendes Schreiben geht. Sie zeichnen sich aus durch ein sattes und konstant ausdrucksstarkes Schriftbild – eben Qualität, auf die man sich verlassen kann. Die uma Tech® Mine – die perfekte Verbindung von Technologie und Schreibfreude.

uma Tech® Refill 1.0, 8-0855 ■, 8-0856 □



Europäische Kunststoff-Großraummine mit weißem oder schwarzem Kunststoffrohr, Neusilberspitze und Wolfram-Karbid-Kugel (1.0 mm). Schreibleistung: ca. 4.500 m. Deutsche Schreibpaste von Dokumental® nach ISO-Norm ISO 12757-2, dokumentenecht. Die uma Tech Refill 1.0 vermittelt ein angenehmes und weiches Schreibgefühl.

European large-capacity plastic refill with white or black plastic tube, new silver writing tip and tungsten carbide ball (1.0 mm). Writing length: approx. 4,500 meters. German writing paste by Dokumental® according to ISO-Norm ISO 12757-2, document proofed. The uma Tech Refill 1.0 provides a pleasant and soft writing feeling.

4.500 m 1,0 mm

uma Tech® – our proven quality refill

The uma Tech® refills have long been considered a proven choice when it comes to high quality and long-lasting writing. They are characterized by a full and constant expressive writing style – quality you can rely on. The uma Tech® refill – the perfect combination of technology and writing pleasure.

uma Tech® Refill 1.0 XL, 8-0859 ■, 8-0860 □



Europäische Kunststoff-Großraummine mit weißem oder schwarzem Kunststoffrohr, Edelstahlspitze und Wolfram-Karbid-Kugel (1.0 mm). Schreibleistung: ca. 5.500 m. Deutsche Schreibpaste von Dokumental® nach ISO-Norm ISO 12757-2, dokumentenecht. Die uma Tech Refill 1.0 XL vermittelt ein angenehmes und weiches Schreibgefühl.

European large-capacity plastic refill with white or black plastic tube, stainless steel tip and tungsten carbide ball (1.0 mm). Writing length: approx. 5,500 meters. German writing paste by Dokumental® according to ISO-Norm ISO 12757-2, document proofed. The uma Tech Refill 1.0 XL provides a pleasant and soft writing feeling.

5.500 m 1,0 mm

uma Tech® Refill 1.2, 8-0857 ■, 8-0858 □



Europäische Kunststoff-Großraummine mit weißem oder schwarzem Kunststoffrohr, Neusilberspitze und Wolfram-Karbid-Kugel (1.2 mm). Schreibleistung: ca. 3.500 m. Deutsche Schreibpaste von Dokumental® nach ISO-Norm ISO 12757-2, dokumentenecht. Die uma Tech Refill 1.2 kann in alle gängigen uma Schreibgeräte eingesetzt werden und verspricht pure Schreibfreude.

European large-capacity plastic refill with white or black plastic tube, new silver writing tip and tungsten carbide ball (1.2 mm). Writing length: approx. 3,500 meters. German writing paste by Dokumental® according to ISO-Norm ISO 12757-2, document proofed. The uma Refill 1.2 can be used in all standard writing instruments and promises great writing pleasure.

3.500 m 1,2 mm

uma Tech® Refill 0.8, 8-0851 ■, 8-0852 □



Europäische Kunststoff-Großraummine mit weißem oder schwarzem Kunststoffrohr, Neusilberspitze und Wolfram-Karbid-Kugel (0.8 mm). Schreibleistung: ca. 4.000 m. Deutsche Schreibpaste von Dokumental® nach ISO-Norm ISO 12757-2, dokumentenecht. Die uma Tech Refill 0.8 kann in alle gängigen uma Schreibgeräte eingesetzt werden und ist speziell für den feinen Strich besonders optimiert.

European large-capacity plastic refill with white or black plastic tube, new silver writing tip and tungsten carbide ball (0.8mm). Writing length approx. 4,000 meters. German writing paste by Dokumental® according to ISO-Norm ISO 12757-2, document proofed. The uma Tech Refill 0.8 can be used in all standard writing instruments and is specially optimized for fine strokes.

4.000 m 0,8 mm

uma FlowMotion®

uma FlowMotion® – schreibt, was sie verspricht!

Mit uma FlowMotion® bieten wir eine Mine, die schreibt, was sie verspricht: Das Zusammenspiel aus Minenspitze, Minenkugel und die perfekt zusammengesetzte Schreibpaste lassen ein unvergessliches Schreibgefühl entstehen. Eleganter war Schreiben noch nie: Gleiten Sie sanft über das Papier und wecken Sie mit Ihrer Handschrift pure Emotionen – uma FlowMotion®.

uma FlowMotion® Refill M1.2, 8-0844



Europäische Metall-Großraummine mit Edelstahlspitze und Wolfram-Karbid-Kugel (1.2 mm). Schreibleistung ca. 4.000 m. Deutsche Schreibpaste nach ISO-Norm. Made in Germany. Das Zusammenspiel aus Minenspitze, Minenkugel und perfekt zusammengesetzte Schreibpaste lassen ein unvergessliches Schreibgefühl entstehen.

European large-capacity metal refill with stainless steel tip and tungsten carbide ball (1.2 mm). Writing length approx. 4,000 meters. German ISO-compliant ink paste. Made in Germany. The interplay of lead tip, lead ball and the perfectly composed writing paste create an unforgettable writing experience.

4.000 m 1,2 mm

uma FlowMotion® – writes what it promises!

With uma FlowMotion® we offer a refill that writes what it promises: the combination of refill tip, refill ball and the perfectly composed writing paste create an unforgettable writing experience. Writing has never been more elegant: Slide gently over the paper and arouse pure emotions with your handwriting – uma FlowMotion®.

uma FlowMotion® Refill K1.0, 8-0840



Europäische Kunststoff-Großraummine mit weißem oder schwarzem Kunststoffrohr, Neusilberspitze und Wolfram-Karbid-Kugel (1.0 mm). Schreibleistung: ca. 1.200 m. Deutsche Schreibpaste nach ISO-Norm. Das Zusammenspiel aus Minenspitze, Minenkugel und die perfekt zusammengesetzter Schreibpaste lassen ein unvergessliches Schreibgefühl entstehen.

European large-capacity plastic refill with white or black plastic tube, new silver writing tip and tungsten carbide ball (1.0 mm). Writing length: approx. 1,200 meters. German ISO-compliant ink paste. The interplay of lead tip, lead ball and the perfectly composed writing paste create an unforgettable writing experience.

1.200 m 1,0 mm

Unsere X-20, Jumbo und Extra Class Minen – perfekt angepasst an Ihre Bedürfnisse

Die Mine eines Schreibgerätes muss nicht nur zur jeweiligen Form passen. Auch die Schreibgewohnheiten können unterschiedlich sein. Bei uma erhalten Sie eine breite Palette an Möglichkeiten: Neben der klassischen uma Tech® Mine bieten wir mit der uma X-20, Jumbo und Extra Class Refill weitere hochwertige Minen mit Schreiblängen von 2.000 bis 10.000 Meter.

X-20, Jumbo and Extra Class refills – perfectly adapted to your needs.

The refill of a writing instrument does not only have to fit the respective design. The writing habits can also be different. At uma you will find a wide range of possibilities: In addition to the classic uma Tech® refill, we offer the uma X-20, Jumbo and Extra Class Refill, other high-quality refills with writing lengths from 2,000 to 10,000 meters.

uma Jumbo Refill, 8-0866

Europäische Jumbo Mine mit weißem Kunststoffrohr, silberner Schreibspitze und Wolfram-Karbid-Kugel (1.0 mm). Schreibleistung: ca. 2.500 m. Deutsche Schreibpaste von Dokumental® nach ISO-Norm ISO 12757-2, dokumentenecht.

European Jumbo refill with white plastic tube, silver writing tip and tungsten carbide ball (1.0 mm). Writing length: approx. 2,500 meters. German writing paste by Dokumental® according to ISO-Norm ISO 12757-2, document proofed.

2.500 m 1,0 mm

uma X-20 Refill, 8-0877

Europäische X-20 Kunststoffmine, mit weißem Kunststoffrohr, silberner Schreibspitze und Wolfram-Karbid-Kugel (1.0 mm). Schreibleistung: ca. 2.000 m. Deutsche Schreibpaste von Dokumental® nach ISO-Norm ISO 12757-2, dokumentenecht.

European X-20 refill with white plastic tube, silver writing tip and tungsten carbide ball (1.0mm). Writing length: approx. 2,000 meters. German writing paste by Dokumental® according to ISO-Norm ISO 12757-2, document proofed.

2.000 m 1,0 mm

uma Extra Class Refill, 8-0888

Europäische Metall-Großraummine mit Edelstahl-Schreibspitze und Wolfram-Karbid-Kugel (1.0 mm). Schreibleistung: ca. 10.000 m. Deutsche Schreibpaste von Dokumental® nach ISO-Norm ISO 12757-2, dokumentenecht. Made in Germany.

European large-capacity metal refill with stainless steel tip and tungsten carbide ball (1.0mm). Writing length: approx. 10,000 meters. German writing paste by Dokumental® according to ISO-Norm ISO 12757-2, document proofed. Made in Germany.

10.000 m 1,0 mm

Die uma Rollerballminen – gleiten förmlich über das Papier!

Rollerballminen zeichnen sich durch ein besonders gleichmäßiges und flüssiges Schriftbild aus. Ebenso elegant ist das subjektive Schreib-Empfinden: Rollerballminen verleihen der persönlichen Handschrift eine leichte und sanfte Note. Mit der uma High Class Rollerball Mine vertrauen Sie auf eine Schreibqualität, die angenehmer kaum sein kann.

The uma rollerball refills – literally sliding over the paper

The rollerball refills are characterized by a particularly even and fluid writing style. The subjective writing feeling is just as elegant: rollerball refills provide a light and gentle touch to personal handwriting. With the uma High Class Rollerball refill you can rely on a writing quality that could hardly be more pleasant.

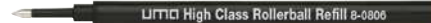
uma High Class Rollerball Refill, 8-0806

Europäische Rollerball-Mine mit Edelstahl-Schreibspitze und Keramik Karbid-Kugel (0.7 mm). Schreibleistung: ca. 800 m. Deutsche Schreibpaste. Made in Germany. Die uma Rollerball-Mine trocknet auch bei abgezogener Kappe nicht sofort aus. Deshalb bescheinigen wir eine extra lange „cap-off“-Zeit.

European rollerball refill with stainless steel writing tip and ceramic ball (0.7 mm). Writing length: approx. 800 meters. German writing paste. Made in Germany. The refill does not dry out immediately, even without the cap, which is why we can testify that it has an extra-long "cap-off" time.

800 m 0,7 mm

uma Patronen-Roller-System

Das **uma Patronen-Roller-System** ist die innovative Basis für neuartige Tintenroller-Schreibgeräte in Premium-Qualität. Dank seiner speziell entwickelten, verschleißarmen Kugelspitze punktet es mit einer bisher unerreichten Langlebigkeit und arbeitet nach dem Prinzip des Füllhalters und kann mit Standard-Tintenpatronen nachgefüllt werden. Die Schreibspitze mit TC-Kugel (0,7 mm) wird also immer wieder verwendet und nicht weggeworfen. So sind, mit dem **uma Patronen-Roller-System** ausgestattete Schreibgeräte nicht nur sehr wirtschaftlich, sondern auch in besonderem Maße umweltfreundlich.

uma cartridge roller system

The **uma cartridge rollerball system** is the innovative foundation for new types of rollerball writing instruments in premium quality. Due to its specially developed, low-wear ball tip, it scores with an unprecedented durability and works on the principle of the foundation pen and can be refilled with standard ink cartridges. The writing tip with TC ball (0.7 mm) is therefore used over and over again and not thrown away. Thus, writing instruments equipped with the **uma cartridge rollerball system** are not only very economical, but also particularly environmentally friendly.

uma Tintenpatrone, 8-0891



Tintenpatronen für das Patronen-Rollerball-System oder für Füllfederhalter.

uma cartridges for the uma cartridge roller system or for the fountain pens.

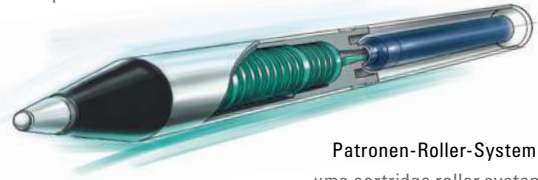

Patronen-Roller-System/
uma cartridge roller system



uma Tintenleitsystem

Das **uma Tintenleitsystem** bietet die Lösung für verschiedene Schreibsysteme in gleichen Modellgehäusen. Ein Tank für Rollerball-, Highlighter- oder Fineliner-Paste in Kombination mit dem innovativen uma Tintenleitsystem ergibt eine höchst flexible Lösung für individuellen Schreibkomfort. Alle verwendeten Pasten sind nach EN-71-3, ASTM D-4236 produziert. Kein Anstechen und eine lange „Cap off“ Zeit versprechen sofortigen und anhaltenden Schreibgenuss. Alle uma Tintenleitsysteme können nachbestellt werden und sind im Schreibgerät einfach auszutauschen. Schreiben und markieren wird so zur „Never Ending Story“.

uma ink flow system

The **uma ink flow system** offers the solution for different writing systems in the same model. A tank for rollerball, highlighter or fineliner paste in combination with the innovative uma ink guiding system provides a highly flexible solution for individual writing comfort. All pastes used are produced according to EN-71-3, ASTM D-4236. No piercing and a long "cap off" time promise immediate and lasting writing pleasure. All uma ink systems can be reordered and are easy to replace in the writing instrument. Writing and marking becomes a "Never Ending Story".

Tintenleitsystem LIQEO Highlighter, 8-0820



Tintenleitsystem für Flüssighighlighter LIQEO mit integriertem Flüssigkeitstank. Das Highlightersystem ist ohne Pumpen oder Anstechen sofort einsatzfähig. Die Documental® Highlighterpaste garantiert bessere Schreibqualität – höhere Leuchtkraft – längere Schreibdauer und ist umweltfreundlicher als herkömmliche Tamponhighlighter, sowie produziert nach EN-71-3, ASTM D-4236.

Ink flow system for liquid highlighter LIQEO with integrated liquid tank. The highlighter system can be used immediately without pumping or injection. The Documental® highlighter paste guarantees better writing quality – higher luminosity – longer writing duration and is more environmentally friendly than conventional tampon highlighters. It is also produced according to EN-71-3, ASTM D-4236.

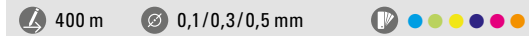

Tintenleitsystem Fineliner, 8-0821



Tintenleitsystem für Fineliner mit integriertem Flüssigkeitstank. Das Finelinersystem ist ohne Pumpen oder Anstechen sofort einsatzfähig. Die Finelinerpaste in Kombination mit der Finelinerspitze (0.4 mm) ermöglicht präzises Schreiben und Markieren und ist nach EN-71-3, ASTM D-4236 produziert.

Ink flow system for fineliner with integrated liquid tank. The fineliner system can be used immediately without pumping or injection. The fineliner paste in combination with the fineliner tip (0.4mm) enables precise writing and marking and is produced according to EN-71-3, ASTM D-4236.



Tintenleitsystem Rollerball, 8-0822



Tintenleitsystem für Rollerball mit integriertem Flüssigkeitstank. Das Rollerballsystem ist ohne Pumpen oder Anstechen sofort einsatzfähig. Die Rollerballpaste in Kombination mit der TC Rollerballschreibspitze (0.7 mm) sorgt für feines und flüssiges Schreiben und ist nach EN-71-3, ASTM D-4236 produziert.

Ink flow system for rollerball with integrated liquid tank. The rollerball system can be used immediately without pumping or injection. The rollerball paste in combination with the TC rollerball writing tip (0.7 mm) ensures fine and fluid writing and is produced according to EN-71-3, ASTM D-4236.



Sauberes Schriftbild für jedes Budget

Die uma Economy-Minen verbinden Schreibqualität mit Budgetvorgaben. So muss bei den uma Economy-Minen nicht auf die uma Schreibqualität verzichtet werden. Für den kleineren Preis sind allerdings kürzer Schreibblängen anzusetzen.

Perfect caption for each budget

uma Economy refills combine writing quality with budget targets. This means that uma Economy refills do not have to do without uma writing quality. For the smaller price, however, shorter writing lengths should be used.

uma Economy Jumbo Refill, 8-0865

Jumbo Mine mit weißem Kunststoffrohr, silberner Schreibspitze und Wolfram-Karbid-Kugel (1.0 mm). Schreibleistung: ca. 1.200 m. Schreibpaste nach ISO-Norm.

Jumbo refill with white plastic tube, silver writing tip and tungsten carbide ball (1.0 mm). Writing length: approx. 1,200 meters. ISO-compliant ink paste.

**uma Economy X-20 Refill, 8-0875**

X-20 Kunststoffmine, mit weißem Kunststoffrohr, silberner Schreibspitze und Wolfram-Karbid-Kugel (1.0 mm). Schreibleistung: ca. 1.000 m. Schreibpaste nach ISO-Norm.

X-20 refill with white plastic tube, silver writing tip and tungsten carbide ball (1.0 mm). Writing length: approx. 1,000 meters. ISO-compliant ink paste.

**uma Economy Refill, 8-0854**

Kunststoff-Großraummine mit weißem Kunststoffrohr, silberner Schreibspitze und Wolfram-Karbid-Kugel (1.0 mm). Schreibleistung: ca. 1.500 m. Schreibpaste nach ISO-Norm.

Large-capacity plastic refill with white plastic tube, silver writing tip and tungsten carbide ball (1.0 mm). Writing length: approx. 1,500 meters. German ISO-compliant ink paste.

**uma Economy Class Refill, 8-0883**

Metall-Großraummine mit Neusilberspitze und Wolfram-Karbid-Kugel (1.0 mm). Schreibleistung: 3.500 m. Schreibpaste nach ISO-Norm.

Large-capacity metal refill with new silver tip and tungsten carbide ball (1.0 mm). Writing length: 3,500 meters. ISO-compliant ink paste.

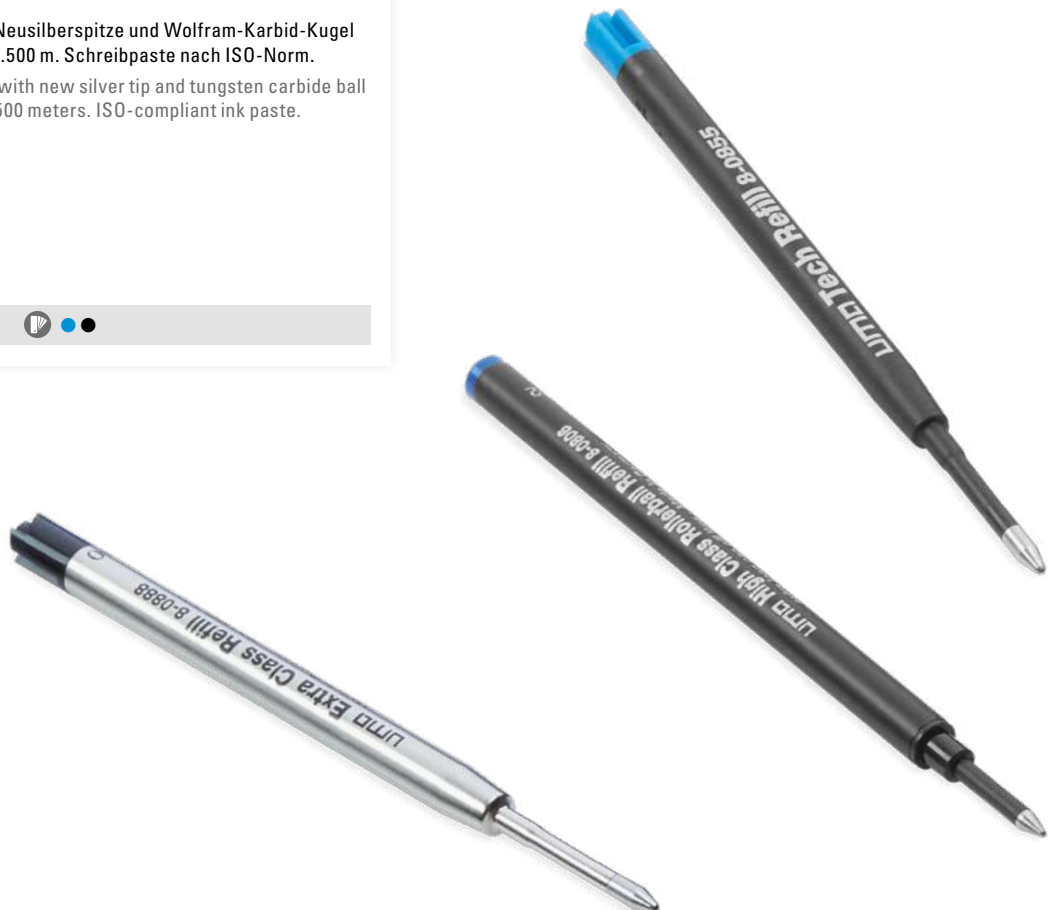

Für den ganz speziellen Strich geeignet

Mit den uma Spezial-Minen bieten wir Ihnen neben weiteren Schreibeigenschaften auch andere Minen an, die das Schreiben in Sonderformaten ermöglichen. Auch hier müssen Sie auf gewohnten uma Schreibkomfort nicht verzichten.

Suitable for the very special stroke

With uma special refills, we offer you besides other writing characteristics also other refill designs that allow writing in special forms. Here, you do not have to do without the usual uma writing comfort.

uma High Class Refill, 8-0886

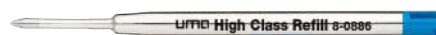

Europäische Metall-Großraummine mit Edelstahl-Schreibspitze und Wolfram-Karbid-Kugel (1.0 mm). Schreibleistung: ca. 10.000 m. Deutsche Schreibpaste von Dokumental® nach ISO-Norm ISO 12757-2, dokumentenecht. Made in Germany.

European large-capacity metal refill with stainless steel tip and tungsten carbide ball (1.0 mm). Writing length: approx. 10,000 meters. German writing paste by Dokumental® according to ISO-Norm ISO 12757-2, document proofed. Made in Germany.

10.000 m 1,0 mm ● ●

uma Gliss Liner Refill, 8-0831



Europäische Kunststoff-Fineline-Mine (0.5 mm) mit Kunststoffrohr und Spitzenfassung aus Edelstahl für gleichbleibende Schrift. Tinte nicht löslich. Schreibleistung: ca. 700 m. Deutsche Schreibpaste nach ISO-Norm. Made in Germany.

European plastic fineline refill (0.5 mm) with plastic tube and stainless steel tip setting for a consistent fine writing. Non-erasable ink. Writing length: approx. 700 meters. German ISO-compliant ink paste. Made in Germany.

700 m 0,5 mm ● ●

uma D1 Refill, 8-0894



Metall D1 Mine mit Metallrohr und Edelstahlschreibspitze (1.0 mm). Schreibleistung: ca. 600 m.

Metal-D1 refill with metal tube and stainless steel tip (1.0 mm). Writing length: approx. 600 meters.

600 m 1,0 mm ● ●





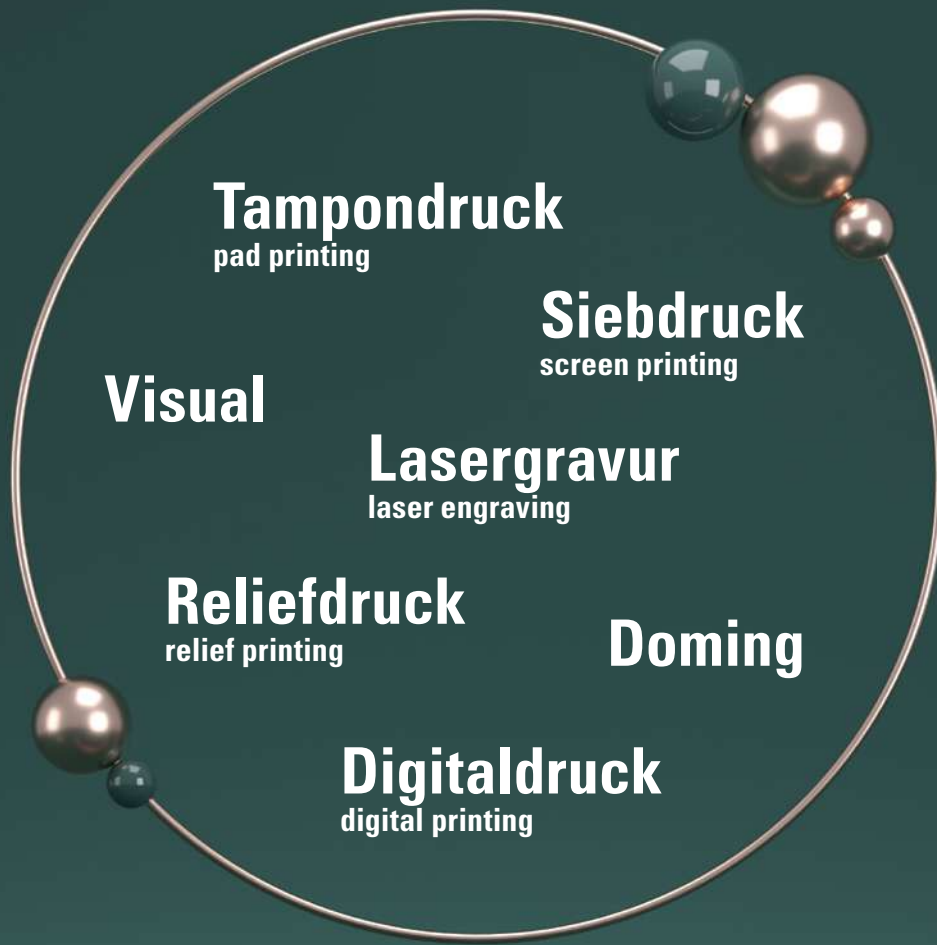

DRUCKVORLAGEN & VEREDELUNG

PRINTING TEMPLATES & FINISHING



So werden aus Schreibgeräten elegante Werbeträger

Unser Ziel ist es aus dem Schreibgerät einen optimalen Werbeträger zu erzeugen. Hierzu verwenden wir den innovativsten und modernsten Veredelungspark Europas. Unsere langjährige Erfahrung geben wir gerne an unsere Kunden weiter, um die Zufriedenheit nachhaltig sicherzustellen. Für die Erzielung des optimalsten Druckergebnisses kann es nötig sein den Druck weiß zu unterlegen oder einen Doppeldruck umzusetzen. In diesen Fällen stimmen wir zusätzliche Druckkosten mit Ihnen ab.

Je nach Farbgebung bzw. Materialbeschaffenheit (transparente Gehäuse) empfehlen wir Druckfarben einzusetzen, die in einem starken Kontrast zur Schreibgerätefarbe stehen. Dies optimiert die Sichtbarkeit und die Lesbarkeit des Druckes.



Siebdruck (S, MS, GS)

Die gängigste und rationellste Form der Schreibgeräteveredelung findet zumeist Einsatz für den Schaftdruck. Aus der Druckvorlage wird ein Film generiert und durch einen photochemischen Prozess auf das Sieb aufgetragen. Dabei werden lediglich die zu druckenden Partien farbdurchlässig – und erscheinen so durch einen Pressvorgang auf dem Werbeträger.

Mit dem Siebdruck ist es möglich, mehrfarbige Rundumdrücke zu gestalten und somit die Werbefläche des Kugelschreibers optimal zu nutzen. Dabei lassen sich sowohl Strich- als auch Rastervorlagen (33er bis 48er Raster) auf allen Materialien umsetzen.



Tampondruck (T, MT, GT, TT)

Der Tampondruck ermöglicht Drucke auf konkaven und konvexen Flächen. Somit findet er überwiegend Einsatz für den Clipdruck bzw. mehrfarbigen Bilderdruck. Aus der Druckvorlage wird ein Film generiert und daraus wiederum ein Klischee erstellt. Mittels eines Tampons (gummierter Stempel) wird die Farbe vom Klischee auf den Werbeträger übertragen.

Die Werbefläche, die so ausgeschöpft werden kann, weist bei zylindrischen Schreibgeräten eine maximale Höhe von 2/3 des Durchmessers auf. Der Tampondruck kann auf allen Materialien eingesetzt werden.



Lasergravur (L, RL, EL)

Die Lasertechnik eröffnet ganz neue Produktionsmöglichkeiten, weil hier noch feinere und präzisere Bearbeitungen möglich sind, und das in allen Materialien. Vor allem bei Metalloberflächen spielt der Laser seine ganze Stärke aus, indem er millimetergenau eine feine Schicht der Kugelschreiberoberfläche abträgt. Personalisierungen oder Rundumgravuren sind im uma Programm Dank der modernsten Lasertechnik auch hochglänzend umsetzbar.



uma Digitaldruck (HD)

Schnell, direkt und persönlich auf Ihre Kunden Eindruck machen – im Digitaldruck lässt sich Ihr Wunsch-Kugelschreiber ganz einfach realisieren. Vorhang auf für Ihre Ideen und unterschiedlichen Werbebotschaften: Bunte Logos, Farbverläufe und Gradierungen, und das auch in geringen Stückzahlen – so flexibel ist kaum eine andere Drucktechnik. Zu beachten ist lediglich, dass die Farbwerte, die hier in CMYK umgewandelt werden, von den exakten PMS-Farben leicht abweichen können. Die Drucktechnik ist auf flache Ebenen beschränkt und kann nicht für konkave oder konvexe Flächen eingesetzt werden.

Die Haftfähigkeit von Druckfarben auf Kunststoffmodellen kann nicht mit den besonderen Oberflächenbeschaffenheiten von Metallschreibgeräten (Druckschlüssel MT/MS) oder gummierten Softtouch-Oberflächen (Druckschlüssel GT) verglichen werden.

Die Druckergebnisse auf diesen Oberflächen sind grundsätzlich stabil, es gelten jedoch höhere Abriebwahrscheinlichkeiten und eine geringere Kratzfestigkeit, als bei Drucken auf Kunststoffen.



uma VISUAL Folientransferdruck (V)

Von Produktdarstellungen und Anzeigenmotiven über eigene Designentwürfe bis hin zu ganzen Bildwelten – die neue Veredelungstechnik uma VISUAL eröffnet nahezu grenzenlose individuelle Gestaltungsmöglichkeiten um den kompletten Kunststoffschafft herum. Die Trägerfolie gibt unter Druck und Hitzeeinwirkung das Druckmotiv auf den Schaft ab. Das „aufgebügelte“ Motiv umschließt den Schaft komplett (360 Grad-Druck).



uma Reliefdruck (RD)

Fühlen Sie Ihre Werbebotschaft. Mit dem Reliefdruck wird jedes Logo greifbar. Zusätzlich zu einem normalen Tampon-, Sieb-, oder Digitaldruck wird ein klarer UV-Lack über das Logo gezogen. Die zusätzliche Lackschicht gibt dem Logo eine 3D-Optik und einen besonderen Glanz.



Doming (D)

Das Herstellungsverfahren einer gewölbten, dekorativen, dreidimensionalen Oberflächenbeschichtung nennt man Doming. Diese Beschichtung besteht aus Kunstharz und besitzt in der Regel eine gläserne hochtransparente Optik. Dies verstärkt die ästhetische Wirkung eines Motives und kann sowohl auf Kunststoff als auch auf Metallschreibgeräten aufgeklebt werden.

Druckvorlagen

Für ein optimales Druckergebnis bedarf es optimaler Druckvorlagen. Für die verschiedenen Veredelungstechniken benötigen wir vektorisierte Druckdateien mit einer Mindestauflösung zwischen 600 und 1.200 dpi – optimal sind EPS-Daten. Weiter eignen sich TIFF- oder JPG-Daten mit gleicher Auflösung.

Gestellte Filme können nur nach Prüfung der hausinternen Repro-Abteilung und lediglich im Fall des Siebdruckes eingesetzt werden.

Für Mehrfarbdrucke, Rasterdrucke und Tampondrucke können nur hauseigene Filme verwendet werden.

Datenübertragung

In unserem Hause können folgende Softwareversionen verarbeitet werden: Adobe Photoshop, Adobe Illustrator und InDesign. Zur Datenübertragung können die uma Cloud oder E-Mail genutzt werden. Aus Sicherheitsgründen und evtl. Rückfragen bitten wir bei der Datenübertragung immer um Angabe der Firma, Telefon und Auftragsnummer.

This is how writing instruments become elegant advertising media!

Our mission is to create an optimal writing advertising medium. For this we use the most innovative and modern finishing park in Europe. We are happy to share our many years of experience with you to ensure satisfaction in the long term.

In order to achieve the best printing results it may be necessary to underlay the print with white or to implement a double print. In these cases we will coordinate additional printing costs with you.



Silk printing (S, MS, GS)

This is the most popular and efficient method of finishing writing instruments by printing on the barrel. The image to be printed will be generated from the artwork and then applied to the screen using a photochemical process. In this process, only the areas of printing are permeable to ink, causing images to appear on the print substrate by means of a pressing process. With screen printing it is possible to achieve multi-colour and all-round prints, which makes optimum use of the promotional surface of the ballpoint pen. This means, that line as well as grid templates can be implemented. Please contact our experts if you require further detailed information.



Pad Printing (T, MT, GT, TT)

Pad printing allows to print on concave and convex surfaces. When it comes to printing on clips it's mostly done by pad printing or multi-coloured image printing. A film will be generated from the artwork, thereof a cliché will be created. By using a silicone pad (like a rubbered stamp) the colour will be transferred from the cliché onto a substrate. The advertising surface of cylindrical writing instruments have a maximum height of 2/3rds of the diameter. Pad printing can be used on any material.



Laser technology (L, RL, EL)

The laser technology opens up completely new possibilities of manufacturing because even finer and more precise processing are possible, with any materials. Especially with metal surfaces, the laser shows its full strength, by removing accurate to the millimetre a fine layer of the writing instruments surface. Thanks to the latest laser technology, high-gloss personalisation and 360°-engraving are included in the uma assortment.



uma Digital printing (HD)

Impress your customers – rapidly, directly and with a personal touch – digital printing enables your desired ballpoint pen to be created very simply. Curtains up for your ideas and on a gamut of promotional messages: Brightly coloured logos, colour schemes and gradations, even in small production runs – virtually no other printing technique delivers this level of flexibility. All you need to consider is, the colour shades which will here be converted into CMYK, may vary slightly from the exact PMS colours. The printing technology is limited to plane surfaces and can't be used on concave and convex surfaces.

Depending on colour or material (transparent housing) we recommend the use of printing inks with a high contrast to the colour of the pen. This optimizes visibility and the legibility of the print.

The durability of printing inks on plastic models can be not compare with the special surface qualities of metal writing instruments (pressure key MT/MS) or rubberised soft-touch surfaces (pressure key GT).

The printing results on these surfaces are basically stable, but higher abrasion probabilities apply and a lower scratch resistance than prints on plastics.



uma VISUAL foil transfer printing (V)

Product images, advertisement motifs, your own design drafts and entire image portfolios – the new uma VISUAL finishing method opens up almost endless individual design choices all around the entire barrel of plastic writing instruments. Under pressure and the effect of the heat, the carrier foil transports the print onto the barrel. The pressed motif covers the barrel completely (360 degree-print).



uma relief print (RD)

Feel your advertising message. With the relief print any logo becomes tangible. Additional to normal pad, silk or digital printing the logo will be covered by a clear UV lacquer. The additional lacquer gives the logo a visual 3D effect and a special glance.



Doming (D)

The manufacturing process of a curved, decorative, three-dimensionally surface coating is called doming. The coating consists of synthetic resin and usually has a glassy high transparent visual effect. This effect intensified the aesthetic impression of the motif. It can be placed on plastic as well as on metal writing instruments.

Printing templates

An optimal printing result requires optimal printing templates. For the different finishing technologies we need vectorised print files with a minimum resolution between 600 and 1.200 dpi – optimal are EPS-files. TIFF or JPG files with a similar resolution are also suitable.

Provided films can only be used after examination of our in-house graphic department and also in case of screen printing. For multicolour-, halftone- and pad printing only in-house films can be used.

Data transmission

We are able to work with the following software versions: Adobe Photoshop, Adobe Illustrator and InDesign. For data transmission you could use the uma Cloud or via E-Mail. For safety reasons and potential inquiries with data transmission we ask for company information, telephone and order number.

Art.-Nr. Item No	Modell Model	Stiftfarben/Colours										Seite Page	
		Silber Silver	Schwarz Black	Weiß White	Blau Blue	Rot Red	Anthrazit Grey	Grün Green	Edelstahl Stainless steel	Glanz- chrom Silver gloss	weitere Farben additional colours		
0-0196 L	RONDO CHROM L												263
0-0962 M	METALLETUI												301
0-0962 ML	METALLETUI												301
0-2608 S TO	SHORTY S TOUCH												279
0-2622	ZIN1												277
0-6100	VIPOLINO												209
0-7200	ALUMA												45
0-7200 T	ALUMA transparent												45
0-8240	SUPREME												267
0-8242 R	SUPREMER												267
0-8250	SLIMLINE												269
0-8250 DOM	SLIMLINE DOM												269
0-8320	SHADOW												273
0-8322 R	SHADOW R												273
0-8330	SIX												257
0-8340	SLIDE												275
0-8340 TO	SLIDE TOUCH												275
0-8342 R	SLIDE R												275
0-8350	SMOKE												259
0-8370	ETERNITY												219
0-8370 M	ETERNITY M												219
0-8372 MR	ETERNITY MR												219
0-8372 R	ETERNITY R												219
0-8380	TALIS												251
0-8450	BOOM												271
0-8450 M	BOOM M												271
0-8800 M	CLASSICO M												224
0-8940 C	GALILEO C												217
0-8950	CARBON												216
0-8952 R	CARBON R												216
0-8956 F	CARBON F												216
0-8957 B	CARBON B												216
0-9100	VIP												211
0-9100 GO	VIP GO												211
0-9100 GUM	VIP GUM												210
0-9102 R	VIP R												211
0-9102 R GUM	VIP R GUM												210
0-9106 F	VIP F												211
0-9107 B	VIP B												211
0-9140	LADY												225
0-9142 R	LADY R												225
0-9143 PR	LADY PR												225
0-9160 M	TITAN M												213
0-9162 MR	TITAN MR												213
0-9180 LE	SILENCE LE												224
0-9182 LE R	SILENCE LE R												224
0-9190	ELEGANCE												215
0-9190 C	ELEGANCE C												214
0-9190 GO	ELEGANCE GO												215
0-9190 LUX	ELEGANCE LUX												214
0-9190 M	ELEGANCE M												215
0-9190 WOOD	ELEGANCE WOOD												75
0-9350	MESH												221
0-9352 R	MESH R												221

Art.-Nr. Item No	Modell Model	Stiftfarben/Colours										Seite Page
		Silber Silver	Schwarz Black	Weiß White	Blau Blue	Rot Red	Anthrazit Grey	Grün Green	Edelstahl Stainless steel	Glanz- chrom Silver gloss	weitere Farben additional colours	
0-9360	TITAN ONE	✳	✳	✳								212
0-9362 R	TITAN ONE R	✳	✳	✳								212
0-9370	TITAN WOOD									■		73
0-9372 R	TITAN WOOD R									■		73
0-9400	ARGON	□										262
0-9412	TAROT	□	□	□	□	□						261
0-9415	LUCKY	■										265
0-9438	COMMA	□	□		□	□						265
0-9440	COSMOS	■										263
0-9450	STRAIGHT	✳	✳	✳	✳		✳					243
0-9450 GUM	STRAIGHT GUM		✳		✳	✳		✳			✳	242
0-9450 M	STRAIGHT M		✳		✳		✳					243
0-9450 M GUM	STRAIGHT M GUM		✳									242
0-9450 GO	STRAIGHT GO		■	■								241
0-9450 RO GO	STRAIGHT RO GO		■	■								241
0-9450 RO GO GUM	STRAIGHT RO GO GUM		■									241
0-9450 SI	STRAIGHT SI	✳	✳	✳	✳	✳		✳			✳	239
0-9450 SI TO	STRAIGHT SI TO	✳	✳	✳	✳	✳		✳			✳	238
0-9452 R SI TO	STRAIGHT SI R TO	✳	✳	✳	✳	✳		✳			✳	238
0-9457 B	STRAIGHT B	✳	✳	✳	✳		✳					243
0-9457 GUM B	STRAIGHT GUM B		✳		✳	✳		✳			✳	242
0-9457 SI B	STRAIGHT SI B	✳	✳	✳	✳	✳		✳			✳	239
0-9460	VENUS	□	□		□	□		□				260
0-9470	MOON	□	□	□	□	□		□				260
0-9480 L	ARGUS L	□	□		□	□		□				262
0-9520	PIANO	□	□	□	□	□	□					259
0-9530	GROOVE	□	□	□	□	□		□			□	255
0-9530 M	GROOVE M		□	□								255
0-9530 TO	GROOVE TOUCH		□	□								255
0-9540 GUM	ELLIPSE GUM		✳		✳	✳	✳	✳			✳	237
0-9560	LUMOS	□	□	□	□	□	□	□			□	247
0-9560 GUM	LUMOS GUM		✳		✳	✳		✳			✳	247
0-9560 M GUM	LUMOS M GUM		■		■	■		■			■	247
0-9560 STONE	LUMOS STONE						□				□	249
0-9575	PRIMUS	□	□	□	□	□		□			□	253
0-9588 TO	SKINNY TOUCH	□	□	□	□			□			□	279
0-9588 M TO	SKINNY M TOUCH		□									279
0-9610 GUM	BRUSH GUM		✳		✳	✳		✳			✳	233
0-9612 R GUM	BRUSH R GUM		✳		✳	✳		✳			✳	233
0-9630 GUM	BRIGHT GUM		✳		✳	✳		✳		■	✳	235
0-9733	PYRA	✳		✳								245
0-9733 GUM	PYRA GUM		✳		✳	✳		✳			✳	245
0-9733 M GUM	PYRA M GUM		✳									245
0-9900	OPERA	■	✳	✳	□	□		□				227
0-9900 M	OPERA M		✳									227
0-9940	SOUL	□	□	□								223
0-9942 R	SOUL R	□	□	□								223
0-9943 PR	SOUL PR	□	□	□								223

Piktogrammzuordnung / Pictogram allocation

LASER hochglanz/silver gloss	LASER gold	LASER rotgold	LASER silber / silver	LASER weiß / white	LASER beige / beige	LASER grau / grey	LASER schwarz glänzend/black gloss
✳	■	■	□	□	■	■	■

Artikel-Nr. Item No.	Modell Model	Werbeschlüssel Advertising code				Seite Page	Artikel-Nr. Item No.	Modell Model	Werbeschlüssel Advertising code				Seite Page
		Schaft Barrel	Clip Clip	Kappe Cap					Schaft Barrel	Clip Clip	Kappe Cap		
0-0011	FANTASY	S ○	T		152	0-0053 MR	QUANTUM MR	T		T		171	
0-0011 T	FANTASY transp.	S ○	T		152	0-0053 PR	QUANTUM PR	T		T		170	
0-0011 T VIS	FANTASY transp. VIS	V	T		147	0-0053 R	QUANTUM R	T		T		170	
0-0011 VIS	FANTASY VIS	V	T		152	0-0056 GREEN	ICON GREEN	S	T			51	
0-0012 SI	ENERGY SI	S ○	L/MT		153	0-0056 M-SI	ICON M SI	S	MT/L			190	
0-0012 TF VIS	ENERGY frozen VIS	V	L/MT		147	0-0056 M-SI GUM	ICON M SI GUM	GS	MT/L			191	
0-0012 TF-SI	ENERGY frozen SI	S ○	L/MT		153	0-0056 SI	ICON SI	S	T			190	
0-0012 VIS	ENERGY VIS	V	L/MT		153	0-0056 TM-SI	ICON transp. M SI	S	MT/L			191	
0-0013 TF	SUNNY frozen	S ○	T		152	0-0056 T-SI	ICON transparent SI	S	T			191	
0-0013 TF VIS	SUNNY frozen VIS	V	T		147	0-0057 GUM	ICONIC GUM	GS	GT			189	
0-0015	DOT	S ○			163	0-0057 RECY	ICONIC RECY	S	T			61	
0-0015 D	DOT D	S ○	T Stopfen/plug		163	0-0058 SI	SPLASH SI	S	T			201	
0-0017	PIXEL	S ○	T		193	0-0058 T-SI	SPLASH transp. SI	S	T			201	
0-0017 F GREEN	PIXEL F GREEN	S ○	T		52	0-0063 F	ON TOP F	S ○	T/HD/RD			177	
0-0017 KG F	PIXEL KG F	S ○	T		193	0-0063 KT-SI GUM	ON TOP KT SI GUM	GS	T/HD/RD			179	
0-0017 RECY	PIXEL RECY	S ○	T		65	0-0063 RECY	ON TOP RECY	S	T/HD/RD			64	
0-0017 TF	PIXEL frozen	S ○	T		193	0-0063 SI	ON TOP SI	S	T/HD/RD			178	
0-0037	HAPPY	S ○	T		110	0-0063 SI F	ON TOP SI F	S	T/HD/RD			178	
0-0037 GUM	HAPPY GUM	GS	GT		110	0-0063 SI GUM	ON TOP SI GUM	GS	T/HD/RD			179	
0-0037 K-TF	HAPPY K frozen	S ○	T		111	0-0063 T-SI	ON TOP transp. SI	S	T/HD/RD			179	
0-0037 RECY	HAPPY RECY	S ○	T		59	0-0071	POP	S	T/HD/RD			185	
0-0037 TF	HAPPY frozen	S ○	T		111	0-0071 RECY	POP RECY	S	T/HD/RD T			63	
0-0039	STRIPE	S	T		201	0-0071 T	POP transparent	S	T/HD/RD T			185	
0-0040 SI	TWISTY SI	S	S		114	0-0077	BEAT	S	T			115	
0-0040 TF	TWISTY frozen	S	S		114	0-0077 T	BEAT transparent	S	T			115	
0-0045	RINGO	S		T	195	0-0086 F-SI	EFFECT F SI	S	S/HD/RD TT	Stopfen/ plug		186	
0-0045 SI	RINGO SI	S		T	195	0-0086 GREEN	EFFECT GREEN	S	S/HD/RD TT	Stopfen/ plug		51	
0-0046	KLICK	S	T		165	0-0086 SI	EFFECT SI	S	S/HD/RD TT	Stopfen/ plug		186	
0-0046 SI	KLICK SI	S	T		165	0-0086 TOP SI	EFFECT TOP SI	S	S/HD/RD TT	Stopfen/ plug		187	
0-0053	QUANTUM	S		T	170	0-0086 TOP T-SI	EFFECT TOP transp. SI	S	S/HD/RD TT	Stopfen/ plug		187	
0-0053 M	QUANTUM M	S		T	171	0-0087	PRIMA	S	T			117	
0-0053 M PR	QUANTUM M PR	T		T	171	0-0090	X-DREAM	S	T			118	

Artikel-Nr. Item No.	Modell Model	Werbeschlüssel Advertising code			Seite Page	Artikel-Nr. Item No.	Modell Model	Werbeschlüssel Advertising code			Seite Page
		Schaft Barrel	Clip Clip	Kappe Cap				Schaft Barrel	Clip Clip	Kappe Cap	
0-0090 CO-SM	X-DREAM CO SM	S	T		118	0-0125 GUM	SKY GUM	GS	T		87
0-0090 SK	X-DREAM SK	S	T		118	0-0125 M	SKY M	S	MT/L		88
0-0090 TF	X-DREAM frozen	S	T		119	0-0125 M-SI	SKY M SI	S	MT/L		88
0-0090 T-SM	X-DREAM transp. SM	S	T		119	0-0125 M-SI GUM	SKY M SI GUM	GS	MT/L		87
0-0092 F	YES F	S ○	T		107	0-0125 TM	SKY transparent M	S	MT/L		89
0-0092 F-SI	YES F SI	S ○	T		107	0-0125 TM-SI	SKY transp. M SI	S	MT/L		89
0-0092 RECY	YES RECY	S ○	T		53	0-0133	TRINITY	T/HD/RD	T		81
0-0092 TF	YES frozen	S ○	T		105	0-0133 GUM	TRINITY GUM	GT/HD/RD	T		84
0-0092 TF-SI	YES frozen SI	S ○	T		105	0-0133 KG-SI GUM	TRINITY KG SI GUM	GT/HD/RD	T		84
0-0093	YES	S ○	T		109	0-0133 KT GUM	TRINITY KT GUM	GT/HD/RD	T		85
0-0093 ANTIBAC	YES antibacterial	S ○	T		53	0-0133 KT-SI GUM	TRINITY KT SI GUM	GT/HD/RD	T		85
0-0093 LUX	YES LUX	S ○	T		109	0-0133 SI	TRINITY SI	T/HD/RD	T		81
0-0093 LUX SI	YES LUX SI	S ○	T		108	0-0133 SI GUM	TRINITY SI GUM	GT/HD/RD	T		84
0-0093 SI	YES SI	S ○	T		108	0-0133 T-SI	TRINITY transp. SI	T/HD/RD	T		81
0-0093 T	YES transparent	S ○	T		109	0-0134 KT-SI	FASHION KT-SI	S ○	T		149
0-0093 T-SI	YES transparent SI	S ○	T		108	0-0134 KT-SI VIS	FASHION KT-SI VIS	V	T		149
0-0096 SI	UP SI	S	S		113	0-0134 SI	FASHION SI	S ○	T		149
0-0096 T-SI	UP transparent SI	S	S		113	0-0134 SI VIS	FASHION SI VIS	V	T		149
0-0112 SI	MEMORY SI	S ○	T		143	0-0136 SI	VOGUE XL SI	S ○			151
0-0112 T-SI	MEMORY transp. SI	S ○	T		143	0-0136 SI VIS	VOGUE XL SI VIS	V			151
0-0119 GUM	WAVE GUM	T/GT	T		155	0-0146 SI	PUR SI	S	L		167
0-0119 M GUM	WAVE M GUM	T/GT	L		155	0-0146 T-SI	PUR transparent SI	S	L		167
0-0122 M-SI	LOOK grip M SI	S	MT/L		161	0-0151	STREAM	T	T		99
0-0122 SI	LOOK grip SI	S	T		160	0-0151 M-SI	STREAM M SI	T	MT/L		99
0-0122 TM-SI	LOOK grip transp. M SI	S	MT/L		161	0-0154 SI	LINEO SI	T	T		103
0-0122 T-SI	LOOK grip transp. SI	S	T		160	0-0154 TF-SI	LINEO frozen SI	T	T		103
0-0124 LUX M-SI	CANDY LUX M SI	S	L		159	0-0155 SI	FUSION SI	S	T		197
0-0124 M-SI	CANDY M SI	S	L		159	0-0155 SI F	FUSION SI F	S	T		197
0-0124 SI	CANDY SI	S	T		157	0-0160	DROP	T	T		199
0-0124 TM-SI	CANDY transp. M SI	S	L		159	0-0160 KT	DROP K transparent	T	T		199
0-0124 T-SI	CANDY transp. SI	S	T		157	0-0177	CORAL	S	T		97
0-0125	SKY	S	T		88	0-0177 GUM	CORAL GUM	GS	GT		95

Artikel-Nr. Item No.	Modell Model	Werbeschlüssel Advertising code			Seite Page	Artikel-Nr. Item No.	Modell Model	Werbeschlüssel Advertising code			Seite Page
		Schaft Barrel	Clip Clip	Kappe Cap				Schaft Barrel	Clip Clip	Kappe Cap	
0-0177 SI	CORAL SI	S	T		97	0-0901	QUATER	TT			294
0-0177 TF	CORAL frozen	S	T		97	0-0909 P	TUBE	TT/HD		TT/HD	295
0-0177 TF-SI	CORAL frozen SI	S	T		97	0-0911	ETUI	TT/HD			300
0-0183 F	VANE F	S	T/HD/RD		181	0-0911 W	ETUI	TT/HD/RD			300
0-0183 RECY	VANE RECY	S	T/HD/RD		62	0-0914	ETUI	TT			298
0-0184 F GUM	VANE F GUM	GS	T/HD/RD		183	0-0914 CI	ETUI CI		individuell individual		298
0-0184 GUM	VANE GUM	GS	T/HD/RD		183	0-0914/2	ETUI	TT			298
0-0184 GUM NEON	VANE GUM NEON	GS	T/HD/RD		182	0-0914/2 CI	ETUI CI		individuell individual		298
0-0184 KG GUM	VANE KG GUM	GS	T/HD/RD		183	0-0915	WRITE & HIGHLIGHT SET	TT	auf Schuber on slip case		287
0-0184 KT GUM	VANE K transp. GUM	GS	T/HD/RD		182	0-0915 CI	WRITE & HIGHLIGHT CI SET		individuell individual		287
0-0185 SI GUM	VANE SI GUM	GS	T/HD/RD		181	0-0915/2	WRITE & HIGHLIGHT SET	TT	auf Schuber on slip case		287
0-0196 L	RONDO chrom L	MS/L			263	0-0915/2 CI	WRITE & HIGHLIGHT CI SET		individuell individual		287
0-0200	TEXTMARKER	P	P		288	0-0917	ETUI	TT			300
0-0200/2	TEXTMARKER 2er-SET	P	P		288	0-0918	CASE	TT/HD /RD			299
0-0200/3	TEXTMARKER SET	P	P	Box TT	288	0-0934	TRANSPARENTES KUNSTSTOFFETUI	TT			294
0-0200/3 SI	TEXTMARKER SET SI	P	P	Box TT	289	0-0940	PAPPSTECKETUI	TT			296
0-0230/3	myBASE	P	P	Box TT/HD	289	0-0940 CI	PAPPSTECKETUI CI		individuell individual		296
0-0240	LIQEO HIGHLIGHTER	P	P		283	0-0940 CI ANTIBAC	PAPPSTECKETUI CI antibacterial				297
0-0240/4	LIQEO HIGHLIGHTER 4er SET	TT/HD	auf Etui/on case		283	0-0940 CI GREEN	PAPPSTECKETUI CI GREEN				297
0-0240-2 P	PAPPFALTSCHACHTEL Verpackung	TT	auf Etui/on case		283	0-0940 CI rPET	PAPPSTECKETUI CI rPET	TT			296
0-0240-3 P	PAPPFALTSCHACHTEL Verpackung	TT	auf Etui/on case		283	0-0940 RECY	PAPPSTECKETUI RECY	TT			296
0-0250	LIQEO HIGHLIGHTER MINI	P	P		284	0-0942	PAPPSTECKETUI	TT			297
0-0250/4	LIQEO HIGHLIGHTER MINI 4er SET	TT/HD	auf Etui/on case		284	0-0943	SQUARE	TT			295
0-0270	LIQEO HIGHLIGHTER PEN	P	P		285	0-0944	BOX	TT/HD/RD			299
0-0270/4	LIQEO HIGHLIGHTER PEN 4er SET	TT/HD	auf Etui/on case		285	0-0955 rPET	ETUI rPET	HD			297
0-0506 KE	DESK KE	TT/HD	auf Werbeplatte/on panel		293	0-0962 M	METALLETUI M	TT/L			301
0-0506 LUX-KE	DESK LUX KE	TT/HD	auf Werbeplatte/on panel		293	0-0962 ML	METALLETUI ML	TT/L			301
0-0531	OMEGA grip	S	T		141	0-2210 F	RECYCLED PET PEN STEP F	S	T		27
0-0531 T	OMEGA grip transp.	S	T		141	0-2210 TF	RECYCLED PET PEN STEP frozen	S	T		27
0-0580	JAZZ	S			168	0-2240	RECYCLED PET PEN switch	S	T		46
0-0580 TF	JAZZ frozen	S			168	0-2240 KT	RECYCLED PET PEN switch K transparent	S	T		46
0-0900 LE	LEDERETUI	TT			301	0-2240 T	RECYCLED PET PEN switch transparent	S	T		47

Artikel-Nr. Item No.	Modell Model	Werbeschlüssel Advertising code			Seite Page	Artikel-Nr. Item No.	Modell Model	Werbeschlüssel Advertising code			Seite Page
		Schaft Barrel	Clip Clip	Kappe Cap				Schaft Barrel	Clip Clip	Kappe Cap	
0-2240 T KG	RECYCLED PET PEN switch transparent KG	S	T		47	0-8350	SMOKE	MS/L			259
0-2250	RECYCLED PET PEN PRO	S	T		28	0-8370	ETERNITY	MT/L		MT/L	219
0-2250 ANTIBAC	RECYCLED PET PEN PRO antibacterial	S	T		41	0-8370 M	ETERNITY M	MT/L		MT/L	219
0-2250 F	RECYCLED PET PEN PRO F	S	T		28	0-8372 MR	ETERNITY MR	MT/L		MT/L	219
0-2250 F OCEAN	RECYCLED PET PEN PRO F ocean	S	T		39	0-8372 R	ETERNITY R	MT/L		MT/L	219
0-2250 F-SI	RECYCLED PET PEN PRO F SI	S	T		37	0-8380	TALIS	MS/L	L		251
0-2250 F TO	RECYCLED PET PEN PRO F TOUCH	S	T		43	0-8450	BOOM	MS/L			271
0-2250 T	RECYCLED PET PEN PRO transparent	S	T		29	0-8450 M	BOOM M	MS/L			271
0-2250 TF	RECYCLED PET PEN PRO frozen	S	T		29	0-8600	ARCTIS	S	L		169
0-2250 TF-SI	RECYCLED PET PEN PRO frozen SI	S	T		37	0-8600 GO	ARCTIS GO	S	L		169
0-2252 R	RECYCLED PET PEN PRO R	S	T	T	34	0-8607 B	ARCTIS B	S	L		169
0-2254 FL	RECYCLED PET PEN PRO FL	S	T	T	34	0-8800 M	CLASSICO M	MS/L	L	MT/L	224
0-2255	RECYCLED PET PEN PRO LIQEO	S	T	T	35	0-8900	NOBILIS	MS			217
0-2260	RECYCLED PET PEN	S	T	TT Stopfen/plug	48	0-8907 B	NOBILIS B	MS			217
0-2260 T	RECYCLED PET PEN transparent	S	T	TT Stopfen/plug	49	0-8940 C	GALILEO C	MS		MT/L	217
0-2260 T SG	RECYCLED PET PEN transparent SG	S	T	TT Stopfen/plug	48	0-8950	CARBON	MS		MT/L	216
0-2608 S-TO	SHORTY S TOUCH	MT/L			279	0-8952 R	CARBON R	MT		MT/L	216
0-2622	2in1	MS/L	L		277	0-8956 F	CARBON F	MT		MT/L	216
0-2622 SET	2in1 SET	MS/L Schreib- gerät/Pen	L		277	0-8957 B	CARBON B	MS		MT/L	216
0-6100	VIPOLINO	MS/L/RL	L	MT/L	209	0-9100	VIP	MS/L/RL	L	MT/L	211
0-7200	RECYCLED PET PEN ALUMA	MS/MT/L	MT/L		45	0-9100 GO	VIP GO	MS/L/RL		MT/L	211
0-7200 T	RECYCLED PET PEN ALUMA transparent	MS/MT/L	MT/L		45	0-9100 GUM	VIP GUM	GT/L		GT/L	210
0-8240	SUPREME	MS/L			267	0-9102 R	VIP R	MT/L/RL	L	MT/L	211
0-8242 R	SUPREME R	MT/L		MT/L	267	0-9102 R GUM	VIP R GUM	GT/L		GT/L	210
0-8250	SLIMLINE	MS/L/RL	L		269	0-9106 F	VIP F	MT/L/RL	L	MT/L	211
0-8250 DOM	SLIMLINE DOM	MS/L/RL	L	D Stopfen/plug	269	0-9107 B	VIP B	MT/L/RL	L	MT/L	211
0-8320	SHADOW	MS/L	L	MT/L	273	0-9140	LADY	MS/L		MT/L	225
0-8322 R	SHADOW R	MT/L	L	MT/L	273	0-9142 R	LADY R	MT/L		MT/L	225
0-8330	SIX	MT/L	L		257	0-9143 PR	LADY PR	MT/L		MT/L	225
0-8340	SLIDE	MS/L	L	MT/L	275	0-9160 M	TITAN M	L		L	213
0-8340 TO	SLIDE TOUCH	MS/L	L	MT/L	275	0-9162 MR	TITAN MR	L		L	213
0-8342 R	SLIDE R	MT/L	L	MT/L	275	0-9180 LE	SILENCE LE			L	224

Artikel-Nr. Item No.	Modell Model	Werbeschlüssel Advertising code			Seite Page	Artikel-Nr. Item No.	Modell Model	Werbeschlüssel Advertising code			Seite Page
		Schaft Barrel	Clip Clip	Kappe Cap				Schaft Barrel	Clip Clip	Kappe Cap	
0-9182 LE R	SILENCE LE R			L	224	0-9470	MOON	MS/L	L		260
0-9190	ELEGANCE	MS/L	L Stopfen/plug		215	0-9480 L	ARGUS L	MS/L	L		262
0-9190 C	ELEGANCE C	MS	L Stopfen/plug		214	0-9520	PIANO	MS/L	L		259
0-9190 GO	ELEGANCE GO	MS/L	L Stopfen/plug		215	0-9530	GROOVE	MS/L			255
0-9190 LUX	ELEGANCE LUX	L	L Stopfen/plug		214	0-9530 M	GROOVE M	MS/L			255
0-9190 M	ELEGANCE M	MS/L	L Stopfen/plug		215	0-9530 TO	GROOVE TOUCH	MS/L			255
0-9190 WOOD	ELEGANCE WOOD	MS/L	L Stopfen/plug		75	0-9540 GUM	ELLIPSE GUM	GT/L			237
0-9350	MESH			L	221	0-9560	LUMOS	MS/L		MT/L	247
0-9352 R	MESH R			L	221	0-9560 GUM	LUMOS GUM	GS/L		GT/L	247
0-9360	TITAN ONE	MS/L		MT/L	212	0-9560 M GUM	LUMOS M GUM	GS/L		GT/L	247
0-9362 R	TITAN ONE R	MT/L		MT/L	212	0-9560 STONE	LUMOS STONE	L		L	249
0-9370	TITAN WOOD	MS/L		L	73	0-9575	PRIMUS	MS/L	L		253
0-9372 R	TITAN WOOD R	MT/L		L	73	0-9588 M TO	SKINNY M TOUCH	MS/L	L	MT/L	279
0-9400	ARGON	MS/L	L		262	0-9588 TO	SKINNY TOUCH	MS/L	L	MT/L	279
0-9412	TAROT	MS/L			261	0-9610 GUM	BRUSH GUM	GS/L		GT/L L/D Stopfen/plug	233
0-9415	LUCKY	MS/L			265	0-9612 R GUM	BRUSH R GUM	GT/L		GT/L L/D Stopfen/plug	233
0-9438	COMMA	MS/L			265	0-9630 GUM	BRIGHT GUM	GS/L	L	L	235
0-9440	COSMOS	MS/L	L		263	0-9733	PYRA	MT/L			245
0-9450	STRAIGHT	MS/L/RL	L		243	0-9733 GUM	PYRA GUM	GT/L			245
0-9450 GO	STRAIGHT GO	MS/L/RL	L		241	0-9733 M GUM	PYRA M GUM	GT/L			245
0-9450 GUM	STRAIGHT GUM	GS/L	L		242	0-9900	OPERA	MS/L/RL			227
0-9450 M	STRAIGHT M	MS/L/RL	L		243	0-9900 M	OPERA M	MS/L/RL			227
0-9450 M GUM	STRAIGHT M GUM	GS/L	L		242	0-9940	SOUL	MS/L		MT/L	223
0-9450 RO-GO	STRAIGHT RO GO	MS/L/RL	L		241	0-9942 R	SOUL R	MT/L		MT/L	223
0-9450 RO-GO GUM	STRAIGHT RO GO GUM	GS/L	L		241	0-9943 PR	SOUL PR	MT/L		MT/L	223
0-9450 SI	STRAIGHT SI	MS/L/RL	L		239	1-0041 RECY	CETA RECY	S ○	T		66
0-9450 SI TO	STRAIGHT SI TOUCH	MS/L	L	MT/L	238	1-0041 SI	CETA SI	S ○	T		135
0-9452 SI R TO	STRAIGHT SIR TOUCH	MT/L	L	MT/L	238	1-0041 TF-SI	CETA frozen SI	S ○	T		135
0-9457 B	STRAIGHT B	MS/L/RL	L		243	1-0043 C-SI	CHILL C SI	S ○	MT/L	T	129
0-9457 GUM B	STRAIGHT GUM B	GS/L	L		242	1-0043 C-SI RECY	CHILL C SI RECY	S ○	MT/L	T	66
0-9457 SI B	STRAIGHT SI B	MS/L/RL	L		239	1-0043 CT-SI	CHILL C transp. SI	S ○	MT/L	T	129
0-9460	VENUS	MS/L	L		260	1-0043 SI	CHILL SI	S ○	MT/L	T	129

Artikel-Nr. Item No.	Modell Model	Werbeschlüssel Advertising code			Seite Page	Artikel-Nr. Item No.	Modell Model	Werbeschlüssel Advertising code			Seite Page
		Schaft Barrel	Clip Clip	Kappe Cap				Schaft Barrel	Clip Clip	Kappe Cap	
1-0043 T-SI	CHILL transp. SI	S ○	MT/L	T	129	5-5200	FOREST	MS/L			71
1-0044 SI	SPOT SI	S ○	T		133	5-5207 B	FOREST B	MS/L			71
1-0044 T-SI	SPOT transp. SI	S ○	T		133	5-5400	TREE	MS/L			69
1-0047 SI	ULTIMO SI	S ○	T		130	5-5600	WOODY	MS/L			70
1-0047 T-SI	ULTIMO transp. SI	S ○	T		130	5-5607 B	WOODY B	MS/L			70
1-0048 SI	ULTIMATE SI	S ○	T/HD/RD		131	5-5800	BEECH	MS/L	L		71
1-0048 SI RECY	ULTIMATE SI RECY	S ○	T/HD/RD		67	5-5900	LEAF	MS/L			69
1-0048 TF-SI	ULTIMATE frozen SI	S ○	T/HD/RD		131	6-2250 H	PAPER PEN	S	MT		77
1-0142 KTF SI	CHECK K frozen SI	S ○	T		126	6-2860 G	FLEXI	S ○			204
1-0142 M-SI	CHECK M SI	S ○	L		125	6-2861 G	FLEXI M	S ○			204
1-0142 SI	CHECK SI	S ○	T		126	6-3000	PREMIUM	S ○			204
1-0142 TF KG SI	CHECK frozen KG SI	S ○	T		127	6-3100	PREMIUM S	S ○			204
1-0142 TF M-SI	CHECK frozen M SI	S ○	L		125	6-3500	VARIO	S ○	T		205
1-0142 TF-SI	CHECK frozen SI	S ○	T		127	6-3500 TF	VARIO frozen	S ○	T		205
1-0145 SI	PEPP SI	S ○	T/HD/RD		132	6-3510	VARIO grip	S ○	T		205
1-0145 T-SI	PEPP transparent SI	S ○	T/HD/RD		132	6-3510 TF	VARIO grip frozen	S ○	T		205
1-0147 SI	CRYS SI	S ○	T	T	137	6-3550	BIO PEN	S ○	T		77
1-0147 T-SI	CRYS transparent SI	S ○	T	T	137	9-0447 TE	HAFTKLAMMER	TT ^{auf Werbeplatte/ on panel}			294
1-0148 SI	GEOS SI	S ○	T	T	139	9-0500	myPENbook	TT/HD Buch, TT/HD Book,	T/HD Schreibgerät T/HD Pen		292
1-0148 TF-SI	GEOS frozen SI	S ○	T	T	139						
1-0149 SI	CHIC SI	S ○	MT/L		134						
1-0149 TF-SI	CHIC frozen SI	S ○	MT/L		134						
1-0504 KE	OFFICE KE	S	TT ^{auf Werbeplatte/ on panel}		293						
1-0504 TE	OFFICE TE	S	TT ^{auf Werbeplatte/ on panel}		293						
1-0690	TORSION	S ○			202						
1-0695	VISTA	S ○			203						
1-0695 TF	VISTA frozen	S ○			203						
1-0735	VIANI	S ○	S		202						
1-0736	VITAN	S ○	T		203						
1-0736 RECY	VITAN RECY	S ○	T		55						
1-0765 T	SPIRIT transparent	S ○	S		202						
5-5100	CALIBRA S	MS/L			70						

○ Rundumdruck möglich

Gültig ab Januar 2023

Unsere Kataloge werden mit größter Sorgfalt zusammengestellt. Trotzdem kann die uma Schreibgeräte Ullmann GmbH für die Fehlerfreiheit und Genauigkeit der enthaltenen Informationen nicht garantieren.

Es gelten unsere allgemeinen Geschäftsbedingungen. Diese finden Sie unter www.uma-pen.com

○ All-around imprint

Valid from January 2023

Our catalogues are compiled with the greatest care. Nevertheless, uma Schreibgeräte Ullmann GmbH cannot guarantee the correctness and accuracy of the corresponding information.

You will find our latest terms and conditions of business at www.uma-pen.com



Die Handschrift der Werbung

